

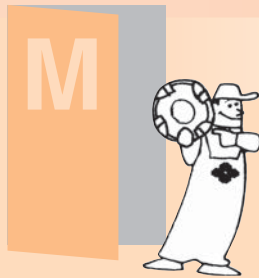

SUMIDIA/SUMIDIA BINDERLESS SUMICRYSTAL

M



Grades	SUMIDIA seriesM2
	SUMIDIA BINDERLESS NPD10/SUMIDIA DA90M4
	SUMIDIA DA1000.....M6
Inserts	SUMIDIA BREAK MASTER LD type/GD typeM7
	SUMIDIA BREAK MASTER DM typeM8
	SUMIDIA Insert Identification CodeM9
	Stock Table for SUMIDIA Indexable Inserts.....M10
	Stock Table for SUMIDIA/SUMIDIA BINDERLESS Indexable InsertsM28
Holders	SEC-Wide-Cut Holders SGW seriesM29
	SUMIDIA Very Small Diameter Boring Bars CKB series.....M30
	SUMIDIA Small Diameter Boring Bars DABB series.....M31
Cutters/ Endmills	 High-efficiency Cutter for Aluminum Alloys ALNEX ANX seriesM32
	High-efficiency Cutter for Aluminum Alloys HF seriesM44
	High-Speed Cutter for Aluminum Alloys RF seriesM50
	High-efficiency Cutter for Aluminum Alloys SRF seriesM52
	SUMIDIA Cutter FAM series/SAM series.....M54
	SUMIDIA Cutter SAM-E type.....M55
	SUMIDIA Mini-Cutter DFE series.....M56
	SUMIDIA BINDERLESS Endmills NPDRS type/NPDBS type/NPDB type.....M57
	SUMIDIA Endmill DFE series.....M61
SUMIDIA Endmill DAE series.....M62	
Drills	SUMIDIA Drill DAL series.....M63
	SUMIDIA Drill DDL seriesM63

M SUMICRYSTAL

SUMICRYSTAL.....	M66
SUMICRYSTAL PD/PDX.....	M67
SUMICRYSTAL UP.....	M68
SUMICRYSTAL UP (Half Cut).....	M69
SUMICRYSTAL UPT.....	M70
SUMICRYSTAL CD.....	M71

Stock Markings and Symbols

- mark: Standard stocked item
- mark: To be replaced with the new item featured on the same page
- ▲ mark: To be replaced by a new product, made to order, or discontinued (please confirm stock availability).
- * mark: Semi-standard stock (please confirm stock availability)
- mark: Stock or planned stock (please confirm stock availability)
- Blank: Made-to-order item
- mark: Not available

SUMIDIA

M

SUMIDIA
BINDERLESS

SUMICRYSTAL

C

D

S

T

V

W

M1

SUMIDIA series



General Features

Our SUMIDIA sintered diamond series has 4 grades (DA90, DA150, DA2200, DA1000) with individual features depending on the optimum combination of diamond particle size and binder, as well as the NPD10 grade (nano-polycrystalline diamond) where nano-order diamond particles are directly bound with high strength without using binders. This series is suited to a wide range of applications from machining of aluminum alloy to machining of hard brittle materials and cemented carbide.

Grades, Features and Applications

Grade	Features	Applications	Average grain size of diamond particles (μm)	Hardness HK (GPa)	Transverse Rupture Strength (GPa)	
SUMIDIA BINDERLESS NPD10	100% diamond structure that directly binds nano-order diamond particles with high strength. Demonstrates optimum wear and fracture resistance as well as the best edge sharpness.	<ul style="list-style-type: none"> Finishing of Cemented Carbide Machining of Hard Brittle Material (Ceramics) 	up to 0.05	120 to 130	≈ 3.15	
SUMIDIA	DA1000	High-density sintered grade made of ultra-fine grain diamond that demonstrates excellent wear and fracture resistance as well as edge sharpness.	<ul style="list-style-type: none"> Machining of High-Silicon Aluminum Alloy Roughing, Interrupted Machining and Finishing of Aluminum Alloy Woodcraft or Wooden Board Cutting/Facing General Finishing of Non-Ferrous Metals 	up to 0.5	50 to 60	≈ 2.60
	DA2200	Sintered grade made of ultra-fine grain diamond that demonstrates optimum wear and fracture resistance and excellent edge sharpness.	<ul style="list-style-type: none"> Roughing, Interrupted Machining and Finishing of Aluminum Alloy Woodcraft or Wooden Board Cutting/Facing 	0.5	45 to 55	≈ 2.45
	DA150	Grade with micro-grained sintered diamond particles. With strong diamond particle bonding, it has an excellent balance of machinability and wear resistance.	<ul style="list-style-type: none"> General Finishing of Non-Ferrous Metals Finishing of Semi-Sintered Ceramics and Mold-Extruded Products FRP, Hard Rubber & Carbon Cutting Wooden or Inorganic Board Cutting/Facing 	5	50 to 60	≈ 1.95
	DA90	Contains coarser diamond particles than other grades, giving it good wear resistance suitable for the machining of carbides and high-silicon aluminum. Shows the highest diamond content for excellent wear resistance.	<ul style="list-style-type: none"> Machining of High-Silicon Aluminum Alloy Machining of Aluminum Composite (MMC) Green or Semi-Sintered Cemented Carbide & Ceramic Roughing Machining of Sintered Ceramics/Stone/Rock 	up to 50	50 to 65	≈ 1.10

Transverse rupture strength measured with test piece equivalent to insert PCD layer

Performance

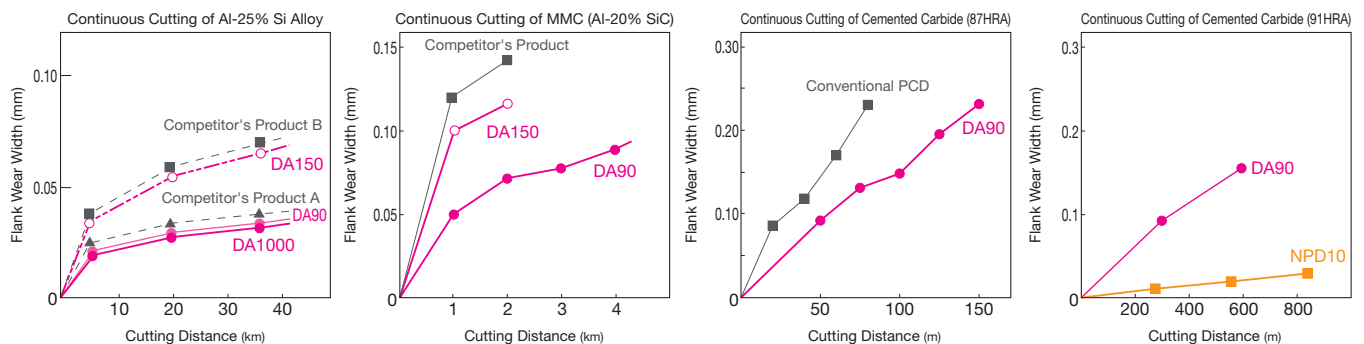

Work Material : Al-25% Si alloy
 Tool Cat. No. : SPGN 120304
 Cutting Conditions : $v_c=500\text{m/min}$,
 $f=0.1\text{mm/rev}$,
 $a_p=0.2\text{mm}$ Dry

Work Material : MMC (Al-20%SiC)
 Tool Cat. No. : CNMX 120408
 Cutting Conditions : $v_c=350\text{m/min}$,
 $f=0.2\text{mm/rev}$,
 $a_p=0.18\text{mm}$ Wet

Work Material :
 Cemented carbide (87HRA)
 Tool Cat. No. : NF-DCMW 070204
 Cutting Conditions : $v_c = 20\text{m/min}$,
 $f = 0.1\text{mm/rev}$,
 $a_p = 0.2\text{mm}$ Wet

Work Material :
 Cemented carbide (91HRA)
 Tool Cat. No. :
 DCMW 11T304RH (NPD10)
 NF-DCMW 11T304(DA90)
 Cutting Conditions : $v_c = 20\text{m/min}$,
 $f = 0.05\text{mm/rev}$,
 $a_p = 0.05\text{mm}$ Dry

SUMIDIA series

Application Range

Aluminum

Machinability	Work Material	Turning		Milling	Example Parts
		Roughing	Finishing		
Good ↑ ↓ Difficult	Sintered Aluminum				Piston Liners
	Wrought Aluminum Alloy				Machine Parts, etc.
	Alloys for Die Casting			Transmission Case, Oil Pan, Cylinder Block, Aluminum Wheel, HDD	
	Alloys for Casting Low Si (≤12%)			Cylinder Head	
	Alloys for Casting High Si (>12%)			Cylinder Block	

Recommended Cutting Conditions (Turning)

Work Material	Cutting Speed vc(m/min)	Feed Rate f(mm/rev)	Depth of Cut ap(mm)
Aluminum Alloy	up to 3,000	up to 0.2	up to 3
Copper Alloy	up to 1,000	up to 0.2	up to 3
Reinforced Plastics	up to 1,000	up to 0.4	up to 2
Wood or Organic Materials (Cutting, etc.)	up to 4,000	up to 0.4	—
Cemented Carbide	up to 30	up to 0.2	up to 0.5
Carbon	100 to 600	1	up to 2

Non-aluminum

Machinability	Work Material	Turning		Milling	Example Parts
		Roughing	Finishing		
Good ↑ ↓ Difficult	Non-ferrous Sintered Alloy				Bush
	Gunmetal Carbon				Connecting Rod
	Carbide				Punches, Dies, Rolls
	Fe Combined				Cylinder Block, Bearing Cap

SUMIDIA Grinding Method

Functions	Description
Grinding Machine	(1) A special-purpose high-rigidity grinding machine. (2) Capable of wet grinding operations.
Grinding Wheel	Abrasive Grain: Diamond
	Grain Size: Rough Grinding: 400 mesh, Finish Grinding: 800 to 1,500 mesh
	Bond: Vitrified or Metal Bond Dedicated for Polycrystalline Diamond Tool
	Concentration: 100 to 125
Grinding Conditions	Dressing: Use a WA stick with a mesh of about 400.
	Peripheral Speed: 800 to 1,000m/min
	Table Rocking: 30 to 60 cycle/min
Others	Grinding Fluid: Water-soluble Grinding Fluid (Solution type)
	(1) The rake face is generally lapped. (2) Inspect for edge chipping using a microscope with a magnification of 30 to 50 times. (3) Machining of non-ferrous metals requires a sharp cutting edge. (4) Surfaces that were cut by EDM should have more than 0.05mm ground off.

*Please contact us for details on regrinding of NPD10.

SUMIDIA
 M
 SUMIDIA BINDERLESS
 SUMICRYSTAL
 C
 D
 S
 T
 V
 W

SUMIDIA BINDERLESS

Nano-polycrystalline Diamond



General Features

Nano-polycrystalline diamond is polycrystalline diamond that directly binds nano-order diamond particles with high strength without using any binders. This Sumitomo Electric proprietary material is harder than polycrystalline diamond with a binder, achieving excellent wear resistance and fracture resistance. SUMIDIA BINDERLESS tools use this super-high-performance nano-polycrystalline diamond material in their cutting edges.

Comparison of Structures

Nano-polycrystalline Diamond Tool SEM Profile

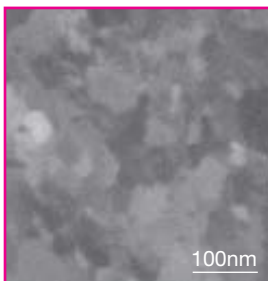

Diamond Particles (30 to 50nm)

Conventional PCD SEM Profile

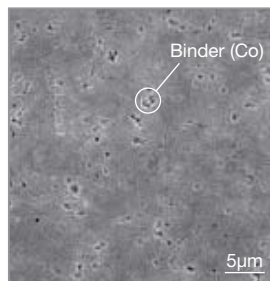

Diamond Particles (1 to 10µm)

Hardness

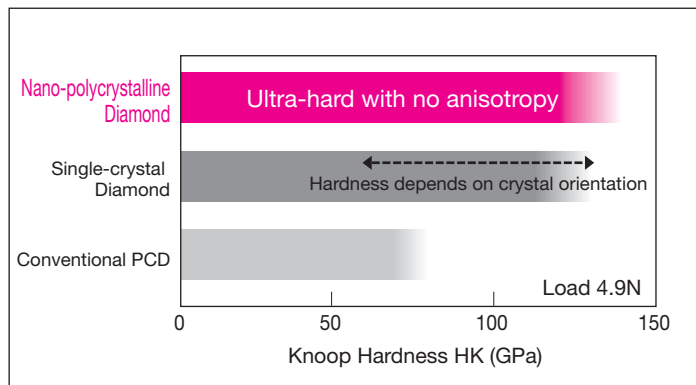

SUMIDIA BINDERLESS

Application Examples

● Ballnose Endmills and Radius Endmills (Cemented Carbide Machining) **M57-**

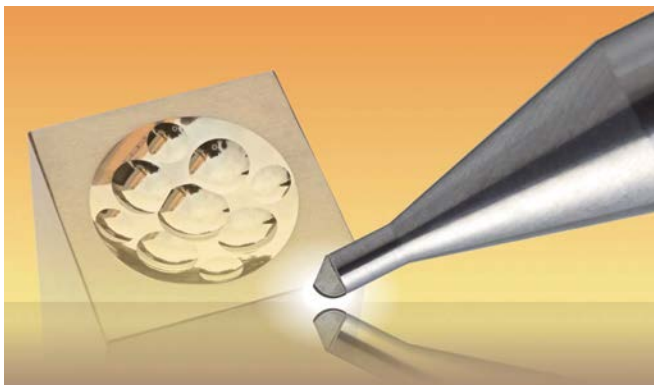

● Indexable Inserts (Cemented Carbide Machining) **M28**

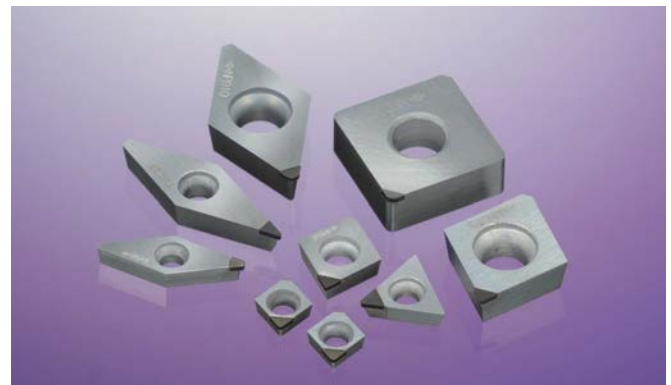

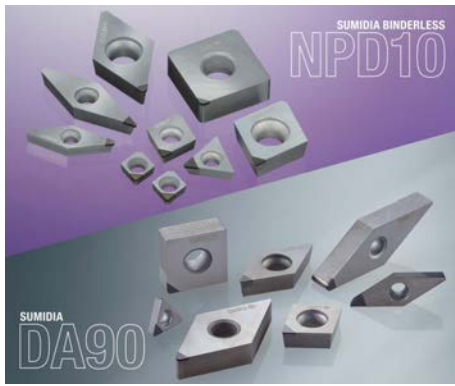

■ **General Features**

NPD10 is made from high-hardness nano-polycrystalline diamond. This is a pure diamond material, but unlike single-crystal diamonds, it has no anisotropy. It achieves extended tool life and machining accuracy superior to conventional diamond tools when machining hard brittle materials such as cemented carbide.

DA90 is a polycrystalline diamond grade in which coarse diamond particles have been sintered to form a dense structure. The high diamond content, with high wear resistance, makes it ideal for roughing of cemented carbide and hard brittle material. Optimised design and mass production technology have been developed, achieving the same performance as conventional tools with higher cost-performance.

■ **Features**

- **Ideal for finishing of hard brittle materials including cemented carbide (NPD10)**
The outstanding wear resistance of nano-polycrystalline diamond enables high-precision machining of cemented carbides.
- **Superior dimensional accuracy maintained for a long time (NPD10)**
Number of tool changes can be drastically reduced compared to conventional diamond tools, enabling work efficiency to be improved and total costs to be reduced.
- **Ideal for roughing of hard brittle materials including cemented carbide (DA90)**
Stable tool life in sintered surface machining of cemented carbide and roughing of hard brittle materials thanks to the outstanding wear resistance of nano-polycrystalline diamond
- **Uses SUMIDIA NF Insert (DA90)**
Optimised design and mass production technology have been developed, achieving the same performance as conventional tools with higher cost-performance.

■ **Application Range (Cemented Carbide Machining)**

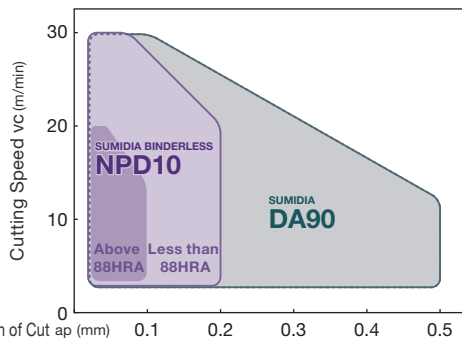

■ **Applications of NPD10 and DA90 (Cemented Carbide Machining)**

Grade	SUMIDIA BINDERLESS NPD10		SUMIDIA DA90	
Dimensional Tolerance	⊙	Best	△	The first recommendation is NPD10
Tool Life (Wear Resistance)	⊙	Best <small>ap = 0.2mm or below f=0.1mm/rev or below recommended</small>	⊙	ap=0.2mm or above can also be used
Sintered surface machining of cemented carbide	✗	Impossible	⊙	Best
Machined surface quality	⊙	Best	△	The first recommendation is NPD10

■ **Recommended Cutting Conditions (Cemented Carbide Machining)**

Work Material				Grade	Cutting Conditions		
Classification	Hardness (HRA)	Our Grades	Cutting Speed vc (m/min)		Feed Rate f (mm/rev)	Depth of Cut ap (mm)	
VM, VC	40	88 or more	G5,D2	NPD10	5 - 15 - 20	0.03 - 0.05 - 0.07	0.03 - 0.05 - 0.07
VM, VC	70,60,50	83 to less than 88	G7,G6	NPD10	5 - 20 - 30	0.03 - 0.10 - 0.20	0.03 - 0.10 - 0.20
VM, VC	—	83 or more	G7,G6 G5,D2	DA90	5 - 20 - 30	0.03 - 0.10 - 0.20	0.03 - 0.20 - 0.50

Min. - Optimum - Max. Coolant: Dry (NPD10)/Wet (DA90)

■ **Machining Precision (NPD10)**

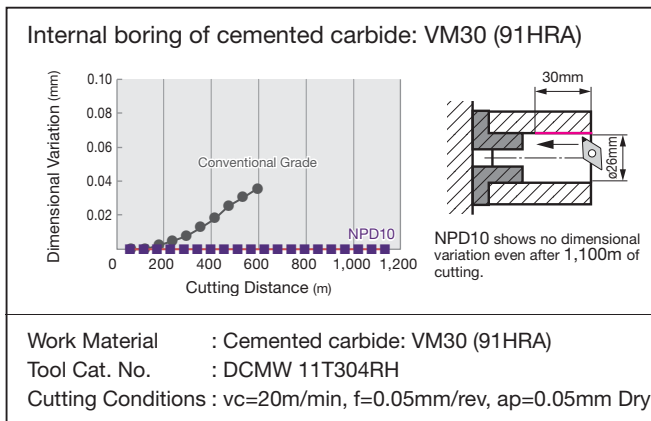

■ **Wear Resistance (DA90)**

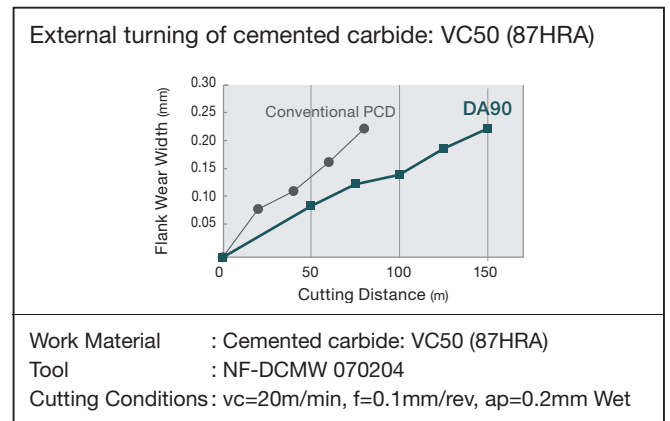

SUMIDIA
M
SUMIDIA BINDERLESS
SUMICRYSTAL
C
D
S
T
V
W

SUMIDIA DA1000



■ Features

Ultra-high-density sintered ultra-fine grained diamond

- Significantly improved surface roughness on machined surfaces
- Excellent wear resistance and strength
- High-performance, high-precision, high-efficiency machining of all aluminum and non-ferrous alloys

■ Position of DA1000

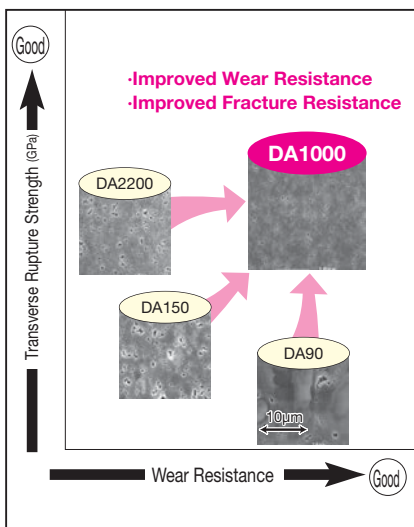

■ Cutting Performance

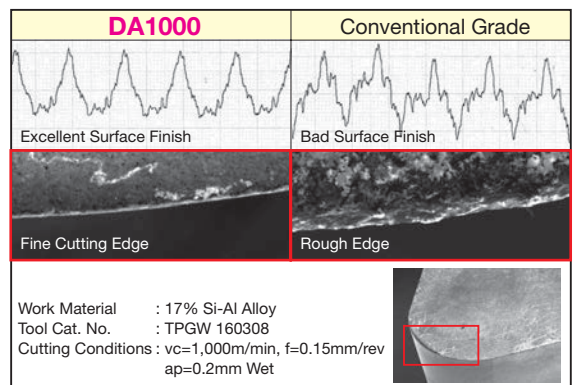
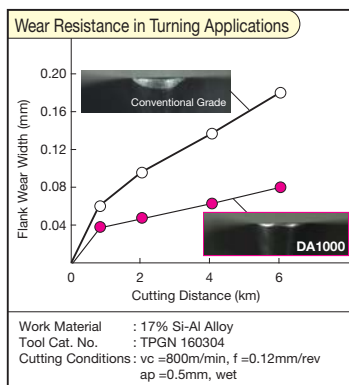

■ NF Insert

The NF type SUMIDIA insert uses optimised design and improved mass production techniques that maintain the good basic performance of DA1000 yet offer higher cost efficiency. It makes the most of the SUMIDIA DA1000 grade, with excellent fracture and wear resistance and good work material finished surface roughness.

- Total cost effectiveness with high performance and lower price
 - Optimum design utilizing improved mass production techniques provides a lower cost.
 - Regrindable type results in huge total cost reduction.
- Wide lineup from general turning to milling
 - Wide range of items in stock for small diameter boring and external turning to milling.
 - Negative/positive type inserts that can be used on standard lever-lock and pin-lock type holder are also in stock.

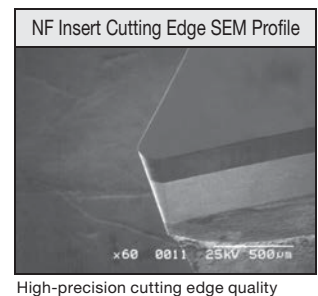

High-precision cutting edge quality

■ Application Examples

● Milling of Aluminum Alloy Oil Pump Cover

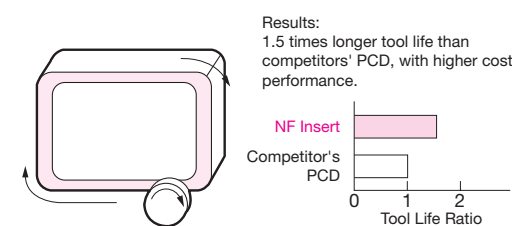

Work Material : ADC12, Tool Cat. No.: NF-TEEN32R
Cutting Conditions : vc = 3,000m/min, fz = 0.06mm/t, ap = 0.2mm Wet

● Boring of Aluminum Valve Bore

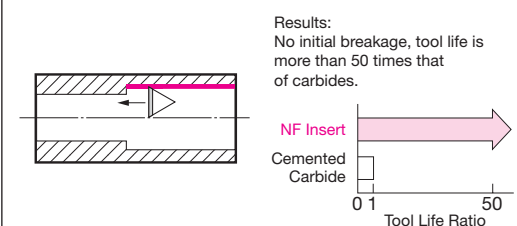

Work Material : ADC12, Tool Cat. No.: NF-TPGN110304P
Cutting Conditions : vc = 530m/min, f = 0.05mm/rev, ap = 0.2mm Wet



■ Features

- SUMIDIA insert with chipbreaker.
- Provides excellent chip control in medium finishing and finishing of aluminum alloy.
- Solves chip control problems and dramatically improves work efficiency.
- Achieves long, stable tool life by employing high-toughness grade DA1000.

■ Application Range

- Wrought Aluminum Alloy (A6061)

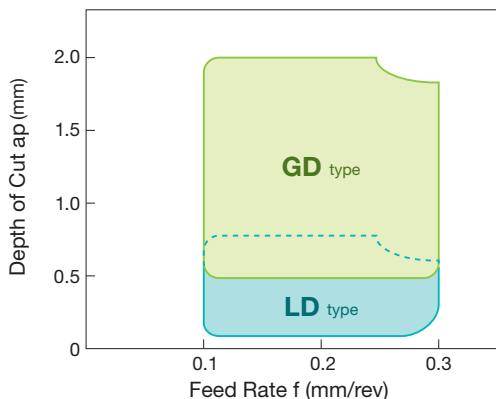

- Cast Aluminum Alloy (ADC12)

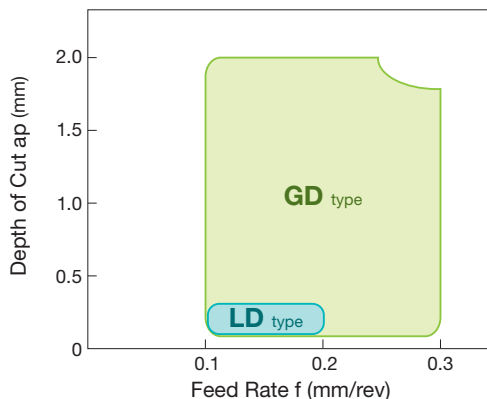

LD type Chipbreaker for Finishing

Provides excellent chip control in finishing



GD type Chipbreaker for Medium Finishing

Provides excellent chip control in medium finishing

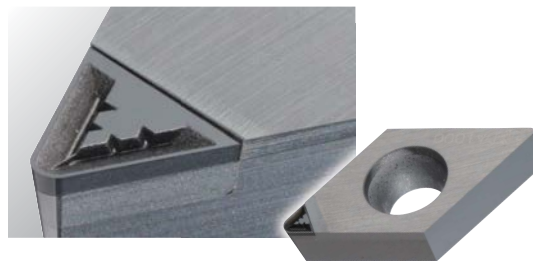

■ Cutting Performance

For Wrought Aluminum Alloy Machining

- Machining Details: Internal Boring of Machine Components

Provides good chip control at shallow depths of cut for wrought materials

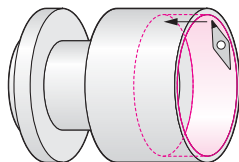

BREAK MASTER LD type



Without Chipbreaker

Work Material : A6061, Tool Cat. No.: NF-VCMT110302N-LD (DA1000)
Cutting Conditions : vc = 200m/min, f = 0.20mm/rev, ap = 0.10mm Wet

■ Cutting Performance

For Aluminum Alloy Casting Machining

- Machining Details: Internal Boring of Transmission Components

Finely breaks chips in machining of cast materials

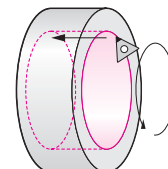

BREAK MASTER GD type



Without Chipbreaker

Work Material : ADC12, Tool Cat. No.: NF-TPMT110304N-GD (DA1000)
Cutting Conditions : vc = 400m/min, f = 0.23mm/rev, ap = 1.20mm Wet

Note: Regrinding this product will adversely affect chip control performance.

DM type

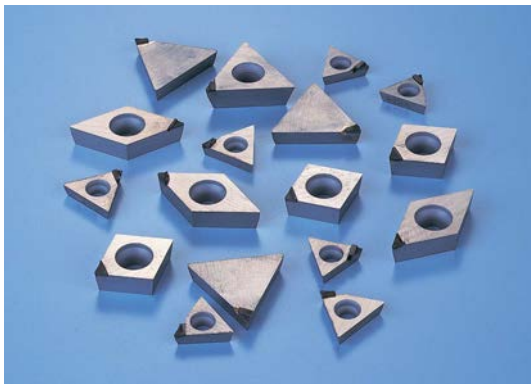

■ Features

- Economy One-Use type
Familiar to users of SUMIBORON one-use inserts, now available in SUMIDIA.
- Cutting Edge with Built-in Chipbreaker for Effective Chip Control
DM type chipbreaker solves chip control problems and greatly improves efficiency.

■ Application Range

- For Internal Boring

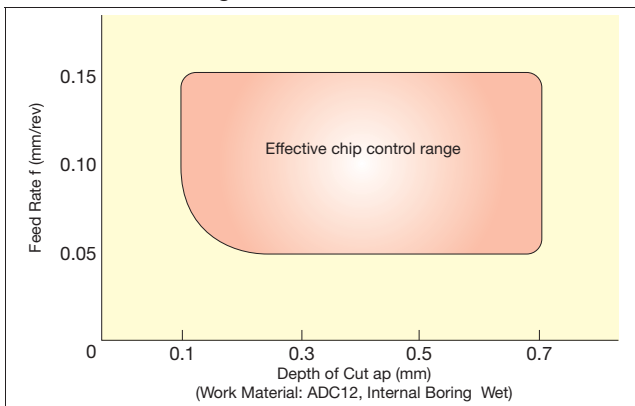

■ Chip Control

- Chips Produced by BREAK MASTER DM type
- Chips with No Chipbreaker



- External Turning & Facing (Insert Shape: 55°/80° Diamond type)

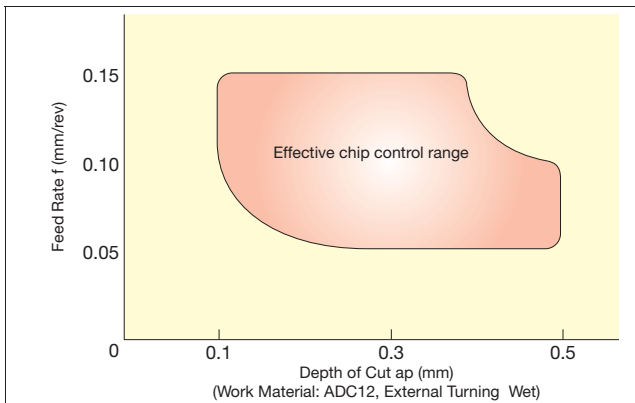

■ Recommended Cutting Conditions

- Internal Boring (Insert Shape: Triangular type)

Feed Rate f	Depth of Cut ap	Coolant
up to 0.15 mm/rev	up to 0.7mm	Wet

- External Profiling (Insert Shape: 55°/80° Diamond type)

Feed Rate f	Depth of Cut ap	Coolant
up to 0.15 mm/rev	up to 0.5mm	Wet

For facing, depth of cut should be less than 0.4mm.

■ Application Examples

Machining Details	Cutting Conditions	Results
Internal Boring	Work Material: AC2A-T6 vc = 300m/min f = 0.06mm/rev ap = 0.35mm Wet	With the required finished surface roughness of Ra = 1μm or less, the chips curled at lengths of 2mm or so, and did not remain within the work material.

■ Series

Machining Details	Internal Boring	External Turning and Facing
Cartridge Unit	NU-TPMR1103 type	—
	NU-TPMR1603 type	—
Tool Holder	NU-TPMT0802 type	NU-CCMT0602 type
	NU-TPMT0902 type	NU-CCMT09T3 type
	NU-TPMT1102 type	NU-DCMT0702 type
	NU-TPMT1103 type	NU-DCMT11T3 type
	NU-TPMT1604 type	—

Insert Identification Code

Regrindable type

CNMX 120408 (B)

(1)

(2)

(1) Insert ISO Code
(ISO Standard Classification)
M6 B2, B3

(2) Additional Information
Refer to Table 1

Table 1 (2) Additional Information

Symbol	Code Description
R	Right-handed
L	Left-handed
B	Full-top PCD type
-WF	Edge with Special Land for Glossy Finishing of Aluminum Wheels
RH	Honing (Cutting Edge Treatment)

Single Corner type

NF - CNMX 120408 (P)

(1)

(2)

(3)

(1) Type Code
Refer to Table 2

(2) Insert ISO Code
(ISO Standard Classification)
M6 B2, B3

(3) Additional Information
Refer to Table 3



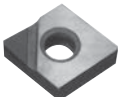
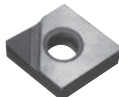

Table 2 (1) Type Code

Symbol	Code Description
NF	NF Insert M6
NU	One-Use Insert (Disposable)

Table 3 (3) Additional Information

Symbol	Code Description
L	Left-handed
P	Full-length Cutting Edge type
N-LD	Chipbreaker type (Neutral) M7
N-GD	Chipbreaker type (Neutral) M7
R-DM	Chipbreaker type (Right-handed) M8
L-DM	Chipbreaker type (Left-handed) M8

Insert Shape

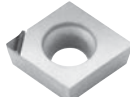
Full-top PCD type	Edge With Special Land for Glossy Finishing of Aluminum Wheels	NF Insert	One-Use Insert	Full-length Cutting Edge type	Chipbreaker type
					

SUMIDIA Inserts

Indexable Inserts

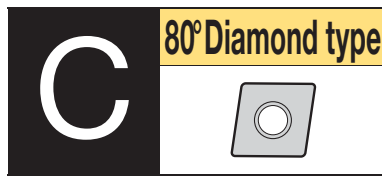

Neg.-Pos.

CNMX 1204				
Dimensions (mm)	Inscribed Circle IC	12.70	Hole Dia.	5.16
	Thickness S	4.76		

Applicable External Holders C10 to C12
Applicable Internal Holders E15, E23 to E25

SUMIDIA
M
SUMIDIA BINDERLESS
SUMICRYSTAL
C
D
S
T
V
W

7° Pos.

CCMW 03X1				
Dimensions (mm)	Inscribed Circle IC	3.5	Hole Dia.	1.9
	Thickness S	1.4		

Applicable Internal Holders E18, E20

CCMW 04X1				
Dimensions (mm)	Inscribed Circle IC	4.3	Hole Dia.	2.3
	Thickness S	1.8		

Applicable Internal Holders E18, E20

CCM 0602				
Dimensions (mm)	Inscribed Circle IC	6.35	Hole Dia.	2.8
	Thickness S	2.38		

Applicable External Holders C13, D13, D17, D22 to D23

Applicable Internal Holders E18 to E20

(Legend) General Cutting 1st Recommendation

Recommended Application	N Non-Ferrous Metal			
	Carbide/Hard Brittle Material			

Shape		Cat. No.	Corner Radius RE	Cutting Edge Length LE	SUMIDIA			
					DA90	DA150	DA1000	DA2200
		NF-CNMX 120402	0.2	5.5	—	—	●	▲
		120404	0.4	5.4	—	—	●	▲
		120408	0.8	5.4	—	—	●	▲
		120412	1.2	5.3	—	—	●	▲
		NU-CNMX 120402	0.2	2.8	—	—	—	—
		120404	0.4	2.8	—	—	—	—
		120412	1.2	2.6	—	—	—	—
		CNMX 120402	0.2	5.5	—	—	●	—
		120404	0.4	5.4	●	●	●	▲
		120408	0.8	5.4	●	●	●	▲
		120412	1.2	5.3	●	—	—	—

		NF-CCMW 03X102	0.2	1.1	●	—	—	—
		03X104	0.4	1.1	●	—	—	—

		NF-CCMW 04X102	0.2	1.5	●	—	—	—
		04X104	0.4	1.5	●	—	—	—

		NF-CCMW 060202	0.2	2.4	●	—	—	—
		060204	0.4	2.4	●	—	—	—

		NF-CCMT 060201	0.1	2.8	—	—	●	▲
		060202	0.2	2.8	—	—	●	▲
		060204	0.4	2.8	—	—	●	▲

		NF-CCMT 060202N-LD	0.2	2.9	—	—	●	—
		060204N-LD	0.4	2.9	—	—	●	—

		NF-CCMT 060202N-GD	0.2	2.9	—	—	●	—
		060204N-GD	0.4	2.9	—	—	●	—

		NU-CCMT 060202R-DM	0.2	2.5	—	●	—	—
		060202L-DM	0.2	2.5	—	●	—	—
		060204R-DM	0.4	2.5	—	●	—	—
		060204L-DM	0.4	2.5	—	●	—	—

		CCMT 060201	0.1	3.3	—	—	●	—
		060202	0.2	3.2	—	—	●	—
		060204	0.4	3.1	—	—	●	—

SUMIDIA Inserts

Indexable Inserts

C

80° Diamond type

7° Pos.

CCM

■

09T3

Dimensions (mm)	Inscribed Circle IC	9.525	Hole Dia.	4.4
	Thickness S	3.97		

Applicable External Holders C13, D13, D17, D22 to D23

Applicable Internal Holders E12, E18 to E20

(Legend) General Cutting ● 1st Recommendation

Recommended Application	N Non-Ferrous Metal			
	●	●	●	●
	Carbide/Hard Brittle Material			
	●	●	●	●

Shape		Cat. No.	Corner Radius RE	Cutting Edge Length LE	Dimensions (mm)			
					DA90	DA150	DA1000	DA2200
 NF Insert		NF-CCMW 09T302	0.2	2.4	●	—	—	—
		09T304	0.4	2.4	●	—	—	—
		09T308	0.8	2.3	●	—	—	—
 NF Insert		NF-CCMT 09T301	0.1	2.8	—	—	●	▲
		09T302	0.2	2.8	—	—	●	▲
		09T308	0.4	2.8	—	—	●	▲
 BREAK MASTER		NF-CCMT 09T302N-LD	0.2	2.9	—	—	●	—
		09T304N-LD	0.4	2.9	—	—	●	—
		09T308N-LD	0.8	2.8	—	—	●	—
 BREAK MASTER		NF-CCMT 09T302N-GD	0.2	2.9	—	—	●	—
		09T304N-GD	0.4	2.9	—	—	●	—
		09T308N-GD	0.8	2.8	—	—	●	—
 BREAK MASTER		NU-CCMT 09T302R-DM	0.2	2.5	—	●	—	—
		09T302L-DM	0.2	2.5	—	●	—	—
		09T304R-DM	0.4	2.5	—	●	—	—
09T304L-DM	0.4	2.5	—	●	—	—		
 NF Insert		CCMT 09T301	0.1	4.2	—	●	—	—
		09T302	0.2	4.2	—	●	—	—
		09T304	0.4	4.2	—	●	—	—

11° Pos.

CPMT

●

●

0802

Dimensions (mm)	Inscribed Circle IC	7.94	Hole Dia.	3.4
	Thickness S	2.38		

Applicable Internal Holders E21 to E22

 NF Insert		CPMT 080202	0.2	4.2	—	—	●	▲
		080204	0.4	4.2	—	—	●	▲
		080208	0.8	4.1	—	—	●	▲

CPMT

●

●

0903

Dimensions (mm)	Inscribed Circle IC	9.525	Hole Dia.	4.4
	Thickness S	3.18		

Applicable Internal Holders E12, E21 to E22

 NF Insert		NF-CPMT 090302	0.2	2.8	—	—	●	▲
		090304	0.4	2.8	—	—	●	▲
		090308	0.8	2.7	—	—	●	▲

▲ mark: To be replaced by a new product, made to order, or discontinued (please confirm stock availability)

SUMIDIA Inserts

Indexable Inserts

D 55° Diamond type

Neg.

DNMA 1504

Dimensions (mm)	Inscribed Circle IC	12.70	Hole Dia.	5.6
Thickness S		4.76		

Applicable External Holders **C14 to C16**

Applicable Internal Holders **E15, E31 to E33**

Neg.-Pos.

DNMX 1504

Dimensions (mm)	Inscribed Circle IC	12.70	Hole Dia.	5.16
Thickness S		4.76		

Applicable External Holders **C14 to C16**

Applicable Internal Holders **E15, E31 to E33**

7° Pos.

DCM 0702

Dimensions (mm)	Inscribed Circle IC	6.35	Hole Dia.	2.8
Thickness S		2.38		

Applicable External Holders **C19, D14, D18 to D19, D24 to D25**

Applicable Internal Holders **E16, E26 to E30**

(Legend) General Cutting ● 1st Recommendation

Recommended Application	N Non-Ferrous Metal			●
	Carbide/Hard Brittle Material	●		

Dimensions (mm)

SUMIDIA

Shape	Cat. No.	Corner Radius RE	Cutting Edge Length LE	SUMIDIA			
				DA90	DA150	DA1000	DA2200
 NF Insert	NF-DNMA 150408 150412	0.8	2.0	●	—	—	—
		1.2	2.0	●	—	—	—

 NF Insert	NF-DNMX 150402 150404 150408 150412	0.2	7.4	—	—	●	▲
		0.4	7.1	—	—	●	▲
		0.8	6.7	—	—	●	▲
		1.2	6.2	—	—	●	▲
 One-Use	NU-DNMX 150402 150404 150408 150412	0.2	3.0	—	—	—	—
		0.4	2.8	—	—	—	—
		0.8	2.5	—	—	—	—
		1.2	2.1	—	—	—	—
	DNMX 150402 150404 150408 150412	0.2	6.4	—	—	●	—
		0.4	6.2	—	—	●	▲
		0.8	5.8	—	—	●	▲
		1.2	5.4	—	—	●	▲

 NF Insert	NF-DCMW 070202 070204	0.2	2.6	●	—	—	—
		0.4	2.4	●	—	—	—
 NF Insert	NF-DCMT 070201 070202 070204	0.1	3.0	—	—	●	▲
		0.2	3.0	—	—	●	▲
		0.4	2.8	—	—	●	▲
 BREAK MASTER	NF-DCMT 070202N-LD 070204N-LD	0.2	3.1	—	—	●	—
		0.4	2.9	—	—	●	—
 BREAK MASTER	NF-DCMT 070202N-GD 070204N-GD	0.2	3.1	—	—	●	—
		0.4	2.9	—	—	●	—
 BREAK MASTER	NU-DCMT 070202R-DM 070202L-DM 070204R-DM 070204L-DM	0.2	2.9	—	●	—	—
		0.2	2.9	—	●	—	—
		0.4	2.7	—	●	—	—
		0.4	2.7	—	●	—	—
	DCMT 070201 070202 070204	0.1	4.3	—	—	●	—
		0.2	4.2	—	—	●	—
		0.4	4.0	—	—	●	—

SUMIDIA

M

SUMIDIA
SUMIDIA
BINDERLESS

SUMICRYSTAL

C

D

S

T

V

W

SUMIDIA Inserts

Indexable Inserts

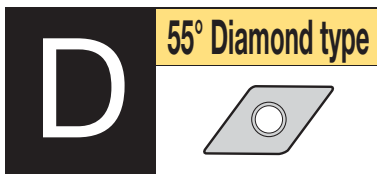

7° Pos.

DCM		11T3	
Dimensions (mm)	Inscribed Circle IC	Hole Dia.	4.4
	Thickness S		

Applicable External Holders: C19, D14, D18 to D19, D24 to D25

Applicable Internal Holders: E13, E26 to E30

(Legend) General Cutting ● 1st Recommendation

Recommended Application	N Non-Ferrous Metal			
	DA90	DA150	DA1000	DA2200
Carbide/Hard Brittle Material	●			

Shape	Cat. No.	Corner Radius RE	Cutting Edge Length LE	SUMIDIA			
				DA90	DA150	DA1000	DA2200
<p>NF Insert</p>	NF-DCMW 11T302	0.2	2.6	●	—	—	—
	11T304	0.4	2.4	●	—	—	—
	11T308	0.8	2.0	●	—	—	—
<p>NF-DCMT</p>	11T301	0.1	3.0	—	—	●	▲
	11T302	0.2	3.0	—	—	●	▲
	11T304	0.4	2.8	—	—	●	▲
<p>NF-DCMT</p>	11T302N-LD	0.2	3.1	—	—	●	—
	11T304N-LD	0.4	2.9	—	—	●	—
	11T308N-LD	0.8	2.5	—	—	●	—
<p>NF-DCMT</p>	11T302N-GD	0.2	3.1	—	—	●	—
	11T304N-GD	0.4	2.9	—	—	●	—
	11T308N-GD	0.8	2.5	—	—	●	—
<p>NU-DCMT</p>	11T302R-DM	0.2	2.9	—	●	—	—
	11T302L-DM	0.2	2.9	—	●	—	—
<p>NU-DCMT</p>	11T304R-DM	0.4	2.7	—	●	—	—
	11T304L-DM	0.4	2.7	—	●	—	—
<p>DCMT</p>	11T301	0.1	4.3	—	●	—	—
	11T302	0.2	4.2	—	●	—	—
	11T304	0.4	4.0	—	●	—	—

SUMIDIA

M

SUMIDIA BINDERLESS

SUMICRYSTAL

C

D

S

T

V

W

▲ mark: To be replaced by a new product, made to order, or discontinued (please confirm stock availability)

SUMIDIA Inserts

Indexable Inserts

(Legend) General Cutting ● 1st Recommendation

Recommended Application	N Non-Ferrous Metal		●	
	Carbide/Hard Brittle Material	●		

Dimensions (mm) SUMIDIA

Shape	Cat. No.	Corner Radius RE	Cutting Edge Length LE		SUMIDIA			
			RE	LE	DA90	DA150	DA1000	DA2200
 NF Insert	NF-SNMA 120408 120412	0.8	2.4	●	—	—	—	
		1.2	2.4	●	—	—	—	

S Square type

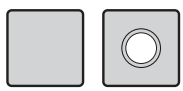

Neg.

SNMA 1204

Dimensions (mm)	Inscribed Circle IC	12.70	Hole Dia.	4.76
	Thickness S	5.16		

Applicable External Holders  C21 to C26

Applicable Internal Holders  E39 to E41

7° Pos.

SCMT 0702

Dimensions (mm)	Inscribed Circle IC	7.94	Hole Dia.	3.4
	Thickness S	2.38		

Applicable External Holders  D26

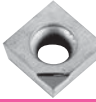
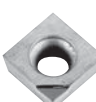
 NF Insert	NF-SCMT 070201 070202 070204	0.1	2.9	—	—	●	—
		0.2	2.9	—	—	●	—
		0.4	2.9	—	—	●	—
	SCMT 070201 070202 070204	0.1	2.9	—	●	—	—
		0.2	2.9	—	●	—	—
		0.4	2.9	—	●	—	—

11° Pos.

SPGN 0903

Dimensions (mm)	Inscribed Circle IC	9.525	Hole Dia.	—
	Thickness S	3.18		

Applicable Internal Holders  E37

Applicable Cartridge: CE type

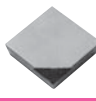
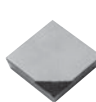

 NF Insert	NF-SPGN 090304 090308	0.4	4.8	—	—	●	▲
		0.8	4.8	—	—	●	▲
	SPGN 090302 090304 090308	0.2	4.8	—	—	—	—
		0.4	4.8	—	—	●	—
		0.8	4.8	—	—	—	—

SPGN 1203

Dimensions (mm)	Inscribed Circle IC	12.70	Hole Dia.	—
	Thickness S	3.18		

Applicable External Holders  C27 to C28

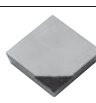
Applicable Cartridge: CE type

 NF Insert	NF-SPGN 120304 120308	0.4	4.8	—	—	●	▲
		0.8	4.8	—	—	●	▲
	SPGN 120304 120308 120312	0.4	4.8	—	—	●	—
		0.8	4.8	—	—	—	—
		1.2	4.8	—	—	—	—

SUMIDIA

M

SUMIDIA
SUMIDIA
BINDERLESS

SUMICRYSTAL

C

D

S

T

V

W

SUMIDIA Inserts

Indexable Inserts

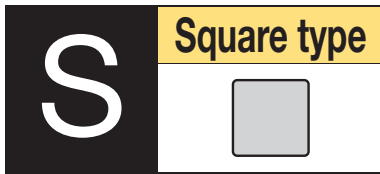



20° Pos.

SEGN 0903			
Dimensions (mm)	Inscribed Circle IC	9.525	Hole Dia.
	Thickness S	3.18	—

Applicable Cartridge: CE type



(Legend) General Cutting ● 1st Recommendation

Recommended Application	N Non-Ferrous Metal			
				●
	Carbide/Hard Brittle Material			
	●			

Shape	Cat. No.	Corner Radius	Cutting Edge Length	SUMIDIA			
				RE	LE	DA90	DA150
 NF Insert	NF-SEGN 090302	0.2	4.8			●	
	SEGN 090302	0.2	4.8		●		
 SEGN 090304 SEGN 090308		0.4	4.8				
		0.8	4.8				

SEGN 1203			
Dimensions (mm)	Inscribed Circle IC	12.70	Hole Dia.
	Thickness S	3.18	—

Applicable Cartridge: CE type

 NF Insert	NF-SEGN 120302	0.2	4.8			●	
	SEGN 120302	0.2	4.8		●		
 SEGN 120304 SEGN 120308		0.4	4.8				
		0.8	4.8				

SUMIDIA

M

SUMIDIA
BINDERLESS

SUMICRYSTAL

C

D

S

T

V

W

SUMIDIA Inserts

Indexable Inserts

T **Triangular type**

Neg.-Pos.

TNMX 1604

Dimensions (mm)	Inscribed Circle IC	9.525	Hole Dia.	3.81
	Thickness S	4.76		

Applicable External Holders C29 to C35, D16, D20

Applicable Internal Holders E15, E47 to E49

(Legend) General Cutting 1st Recommendation

Recommended Application	N Non-Ferrous Metal			
	Carbide/Hard Brittle Material			

Dimensions (mm)

SUMIDIA

Shape	Cat. No.	Corner Radius RE	Cutting Edge Length LE	SUMIDIA			
				DA90	DA150	DA1000	DA2200
 NF Insert	NF-TNMX 160402	0.2	3.7	—	—	●	▲
	160404	0.4	3.6	—	—	●	▲
	160408	0.8	3.3	—	—	●	▲
 One-Use	NU-TNMX 160402	0.2	3.0	—	—		
	160404	0.4	2.9	—	—		
	160408	0.8	2.6	—	—		
 TNMX	TNMX 160402	0.2	3.7			●	
	160404	0.4	3.6			●	▲
	160408	0.8	3.3			●	▲
	160412	1.2	3.0				

5° Pos.

TBGW 0601

Dimensions (mm)	Inscribed Circle IC	3.97	Hole Dia.	2.2
	Thickness S	1.59		

Applicable Internal Holders E42, E44

 NF Insert	NF-TBGW 060102	0.2	2.3	—	—	●	▲
	060104	0.4	2.2	—	—	●	▲
 TBGW	TBGW 060102	0.2	2.3			●	
	060104	0.4	2.1			●	

TBGN 0601

Dimensions (mm)	Inscribed Circle IC	3.97	Hole Dia.	—
	Thickness S	1.59		

Applicable Internal Holders E80

 NF Insert	NF-TBGN 060102	0.2	2.1	—	—	●	▲
	060104	0.4	2.0	—	—	●	▲
 TBGN	TBGN 060102B	0.2	6.5			●	●
	060104B	0.4	6.2			●	●
	060108B	0.8	5.7				

7° Pos.

TCMT 0902

Dimensions (mm)	Inscribed Circle IC	5.56	Hole Dia.	2.5
	Thickness S	2.38		

Applicable External Holders D27

 NF Insert	NF-TCMT 090202	0.2	2.9	—	—	●	▲
	090204	0.4	2.8	—	—	●	▲
 TCMT	TCMT 090201	0.1	2.8	—			
	090202	0.2	2.7			●	
	090204	0.4	2.6			●	

TCMT 1102

Dimensions (mm)	Inscribed Circle IC	6.35	Hole Dia.	2.8
	Thickness S	2.38		

Applicable External Holders D27

 NF Insert	NF-TCMT 110201	0.1	3.0	—	—	●	▲
	110202	0.2	2.9	—	—	●	▲
	110204	0.4	2.8	—	—	●	▲
 TCMT	TCMT 110201	0.1	2.8	—			
	110202	0.2	2.7			●	
	110204	0.4	2.6			●	

SUMIDIA Inserts

Indexable Inserts

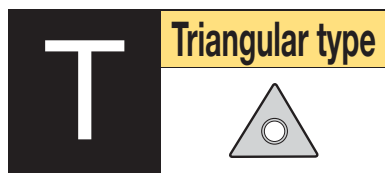

11° Pos.

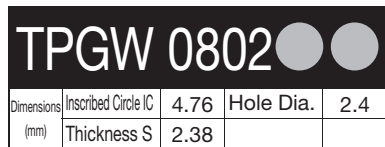

Applicable Internal Holders E42 to E45

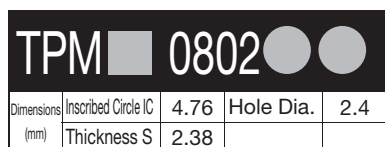

Applicable Internal Holders E42 to E45

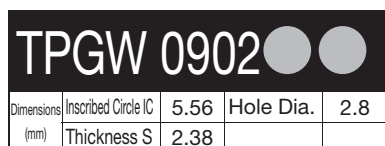

Applicable Internal Holders E42



Applicable Internal Holders E42

(Legend) General Cutting 1st Recommendation

Recommended Application	N Non-Ferrous Metal			
Recommended Application	Carbide/Hard Brittle Material			

Shape	Cat. No.	Corner Radius RE	Cutting Edge Length LE	SUMIDIA			
				DA90	DA150	DA1000	DA2200
 NF Insert	NF-TPGW 080201	0.1	3.1				
	080202	0.2	3.0				
	080204	0.4	2.9				
 TPGW 080202	080204	0.2	2.9				
	080204	0.4	2.7				
	080208	0.8	2.4				
 NF Insert	NF-TPMW 080202	0.2	2.5				
	080204	0.4	2.4				
 BREAK MASTER	NF-TPMT 080202N-LD	0.2	2.9				
	080204N-LD	0.4	2.8				
 BREAK MASTER	NF-TPMT 080202N-GD	0.2	2.9				
	080204N-GD	0.4	2.8				
 BREAK MASTER	NU-TPMT 080202R-DM	0.2	2.5				
	080202L-DM	0.2	2.5				
	080204R-DM	0.4	2.3				
080204L-DM	0.4	2.3					
 NF Insert	NF-TPGW 090202	0.2	3.1				
	090204	0.4	2.9				
 BREAK MASTER	NF-TPMT 090202N-LD	0.2	3.1				
	090204N-LD	0.4	2.9				
 BREAK MASTER	NF-TPMT 090202N-GD	0.2	3.1				
	090204N-GD	0.4	2.9				
 BREAK MASTER	NU-TPMT 090202R-DM	0.2	2.5				
	090202L-DM	0.2	2.5				
	090204R-DM	0.4	2.3				
090204L-DM	0.4	2.3					

SUMIDIA
M
SUMIDIA
BINDERLESS

SUMICRYSTAL

C

D

S

T

V

W

▲ mark: To be replaced by a new product, made to order, or discontinued (please confirm stock availability)

SUMIDIA Inserts

Indexable Inserts

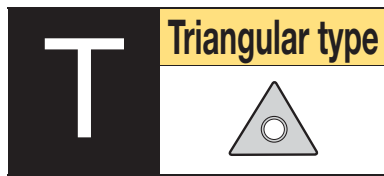

Triangular type

11° Pos.

TPGW 1102

Dimensions (mm)	Inscribed Circle IC	6.35	Hole Dia.	2.8
Thickness S	2.38			

Applicable Internal Holders E42

TPMT 1102

Dimensions (mm)	Inscribed Circle IC	6.35	Hole Dia.	2.8
Thickness S	2.38			

Applicable Internal Holders E42

(Legend) General Cutting 1st Recommendation

Recommended Application	N Non-Ferrous Metal					
	Carbide/Hard Brittle Material					

Dimensions (mm) SUMIDIA

Shape	Cat. No.	Corner Radius RE	Cutting Edge Length LE	SUMIDIA			
				DA90	DA150	DA1000	DA2200
 NF Insert	NF-TPGW 110201 110202 110204	0.1	3.1	—	—	●	▲
		0.2	3.0	—	—	●	▲
		0.4	2.9	—	—	●	▲
	TPGW 110202 110204 110208	0.2	3.7		●		
		0.4	3.6		●		
		0.8	3.3				
 BREAK MASTER	NF-TPMT 110202N-LD 110204N-LD	0.2	3.1	—	—	●	—
		0.4	2.9	—	—	●	—
 BREAK MASTER	NF-TPMT 110202N-GD 110204N-GD	0.2	3.1	—	—	●	—
		0.4	2.9	—	—	●	—
 BREAK MASTER	NU-TPMT 110202R-DM 110202L-DM 110204R-DM 110204L-DM	0.2	2.5	—	—	—	—
		0.2	2.5	—	●	—	—
		0.4	2.3	—	—	—	—
		0.4	2.3	—	●	—	—

SUMIDIA

M

SUMIDIA
SUMIDIA
BINDERLESS

SUMICRYSTAL

C

D

S

T

V

W

SUMIDIA Inserts

Indexable Inserts

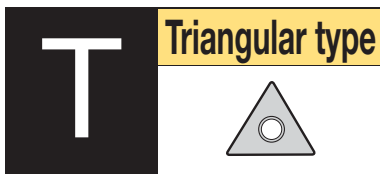

11° Pos.

TPGW 1103				
Dimensions (mm)	Inscribed Circle IC	6.35	Hole Dia.	3.4
	Thickness S	3.18		

Applicable Internal Holders E14, E42 to E45

TPM 1103				
Dimensions (mm)	Inscribed Circle IC	6.35	Hole Dia.	3.4
	Thickness S	3.18		

Applicable Internal Holders E14, E42 to E45

(Legend) General Cutting 1st Recommendation

Recommended Application	N Non-Ferrous Metal			
Carbide/Hard Brittle Material				

Shape		Cat. No.	Corner Radius RE	Cutting Edge Length LE	SUMIDIA			
 NF Insert	 60° RE, 11° LE, IC, S	NF-TPGW 110301	0.1	3.1				
		110302	0.2	3.0				
		110304	0.4	2.9				
		110308	0.8	2.7				
 NF Insert	 60° RE, 11° LE, IC, S	NF-TPGW 110304P <i>new</i>	0.4	10.4				
		110308P <i>new</i>	0.8	9.8				
 NF Insert	 60° RE, 11° LE, IC, S	TPGW 110300	0.05	3.8				
		110302	0.2	3.7				
		110304	0.4	3.6				
		110308	0.8	3.3				
 NF Insert	 60° RE, 11° LE, IC, S	NF-TPMW 110302	0.2	2.5				
		110304	0.4	2.4				
		110308	0.8	2.1				
 NF Insert	 60° RE, 10° LE, 11° IC, S	NF-TPMT 110301	0.1	3.0				
		110302	0.2	2.9				
		110304	0.4	2.8				
		110308	0.8	2.5				
 BREAK MASTER	 60° RE, 11° LE, IC, S	NF-TPMT 110302N-LD	0.2	3.1				
		110304N-LD	0.4	2.9				
		110308N-LD	0.8	2.7				
 BREAK MASTER	 60° RE, 11° LE, IC, S	NF-TPMT 110302N-GD	0.2	3.1				
		110304N-GD	0.4	2.9				
		110308N-GD	0.8	2.7				
 BREAK MASTER	 60° RE, 10° LE, 11° IC, S (Left-Hand)	NU-TPMT 110302R-DM	0.2	2.5				
		110302L-DM	0.2	2.5				
		110304R-DM	0.4	2.3				
		110304L-DM	0.4	2.3				
 NF Insert	 60° RE, 10° LE, 11° IC, S	TPMT 110300	0.05	3.7				
		110302	0.2	3.6				
		110304	0.4	3.5				
		110308	0.8	3.2				

SUMIDIA
M
SUMIDIA BINDERLESS
SUMICRYSTAL



▲ mark: To be replaced by a new product, made to order, or discontinued (please confirm stock availability)

SUMIDIA Inserts

Indexable Inserts

T

Triangular type

11° Pos.

TPGW 1603

Dimensions (mm)	Inscribed Circle IC	9.525	Hole Dia.	4.4
	Thickness S	3.18		

Applicable Internal Holders E42

TPGW 1604

Dimensions (mm)	Inscribed Circle IC	9.525	Hole Dia.	4.4
	Thickness S	4.76		

Applicable Internal Holders E14, E42 to E44

TPM 1604

Dimensions (mm)	Inscribed Circle IC	9.525	Hole Dia.	4.4
	Thickness S	4.76		

Applicable Internal Holders E14, E42 to E44

(Legend) General Cutting ● 1st Recommendation

Recommended Application	N Non-Ferrous Metal								
	Carbide/Hard Brittle Material	●							

Dimensions (mm) **SUMIDIA**

Shape	Cat. No.	Corner Radius RE	Cutting Edge Length LE	SUMIDIA			
				DA90	DA150	DA1000	DA2200
	NF-TPGW 160302	0.2	3.1	—	—	●	▲
	160304	0.4	2.9	—	—	●	▲
	160308	0.8	2.7	—	—	●	▲

	NF-TPGW 160401	0.1	3.1	—	—	●	▲
	160402	0.2	3.0	—	—	●	▲
	160404	0.4	2.9	—	—	●	▲
	160408	0.8	2.7	—	—	●	▲
	NF-TPGW 160404P New	0.4	15.9	—	—	●	—
	160408P New	0.8	15.3	—	—	●	—
	TPGW 160402	0.2	3.7	—	—	●	—
	160404	0.4	3.5	—	—	●	—
	160408	0.8	3.3	—	—	●	—
	160412	1.2	3.0	—	—	—	—

	NF-TPMW 160402	0.2	2.5	●	—	—	—
	160404	0.4	2.4	●	—	—	—
	160408	0.8	2.1	●	—	—	—
	NF-TPMT 160402N-LD	0.2	3.1	—	—	●	—
	160404N-LD	0.4	2.9	—	—	●	—
	160408N-LD	0.8	2.7	—	—	●	—
	NF-TPMT 160402N-GD	0.2	3.1	—	—	●	—
	160404N-GD	0.4	2.9	—	—	●	—
	160408N-GD	0.8	2.7	—	—	●	—

SUMIDIA

M

SUMIDIA
SUMIDIA
BINDERLESS

SUMICRYSTAL

C

D

S

T

V

W

SUMIDIA Inserts

Indexable Inserts

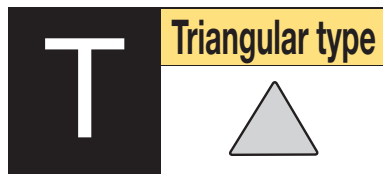

Triangular type

11° Pos.

TPGN 0902			
Dimensions (mm)	Inscribed Circle IC	Hole Dia.	—
	Thickness S		

Applicable Cartridge: CP type

(Legend) General Cutting ● 1st Recommendation

Recommended Application	N Non-Ferrous Metal			
	DA90	DA150	DA1000	DA2200
Carbide/Hard Brittle Material	●			

Shape	Cat. No.	Corner Radius RE	Cutting Edge Length LE	SUMIDIA			
				DA90	DA150	DA1000	DA2200
 NF Insert	NF-TPGN 090202 090204 090208	0.2	3.1	—	—	●	▲
		0.4	3.0	—	—	●	▲
		0.8	2.7	—	—	●	▲
 TPGN 090202	090204 090208	0.2	3.7	—	●	—	—
		0.4	3.6	—	●	—	—
		0.8	3.2	—	—	—	—

TPGN 1103			
Dimensions (mm)	Inscribed Circle IC	Hole Dia.	—
	Thickness S		

Applicable Internal Holders E46

 NF Insert	NF-TPGN 110302 110304 110308	0.2	3.0	—	—	●	▲
		0.4	2.9	—	—	●	▲
		0.8	2.7	—	—	●	▲
 NF Insert	NF-TPGN 110304P 110308P	0.4	10.4	—	—	●	▲
		0.8	9.8	—	—	●	▲
 TPGN 110300	110302 110304 110308	0.05	3.8	—	—	—	—
		0.2	3.7	—	●	—	—
		0.4	3.6	—	●	—	—
		0.8	3.3	—	●	—	—

Part number suffix P: Full-length Cutting Edge type

TPMR 1103			
Dimensions (mm)	Inscribed Circle IC	Hole Dia.	—
	Thickness S		

Applicable Internal Holders E46

 BREAK MASTER	 (Left-handed)	NU-TPMR 110302R-DM 110302L-DM 110304R-DM 110304L-DM	0.2	2.5	—	—	—	—
			0.2	2.5	—	●	—	—
			0.4	2.3	—	—	—	—
			0.4	2.3	—	●	—	—

TPGN 1603			
Dimensions (mm)	Inscribed Circle IC	Hole Dia.	—
	Thickness S		

Applicable External Holders C36 to C37

Applicable Internal Holders E46

 NF Insert	NF-TPGN 160302 160304 160308	0.2	3.0	—	—	●	▲
		0.4	2.9	—	—	●	▲
		0.8	2.7	—	—	●	▲
 NF Insert	NF-TPGN 160304P	0.4	15.9	—	—	●	▲
 TPGN 160302	160304 160308 160312	0.2	3.7	—	●	—	—
		0.4	3.5	—	●	—	—
		0.8	3.3	—	●	—	—
		1.2	3.0	—	—	—	—

Part number suffix P: Full-length Cutting Edge type

TPMR 1603			
Dimensions (mm)	Inscribed Circle IC	Hole Dia.	—
	Thickness S		

Applicable External Holders C36 to C37

Applicable Internal Holders E46

 BREAK MASTER	 (Left-handed)	NU-TPMR 160302R-DM 160302L-DM 160304R-DM 160304L-DM	0.2	2.5	—	—	—	
			0.2	2.5	—	●	—	—
			0.4	2.3	—	—	—	—
			0.4	2.3	—	●	—	—

▲ mark: To be replaced by a new product, made to order, or discontinued (please confirm stock availability)

SUMIDIA Inserts

Indexable Inserts

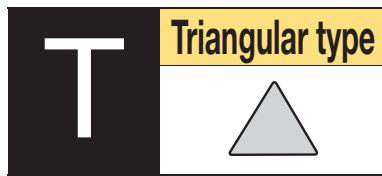

Triangular type

20° Pos.

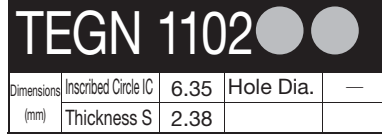

Dimensions (mm)	Inscribed Circle IC	6.35	Hole Dia.	—
	Thickness S	2.38		

Applicable Cartridge: CE type

(Legend) General Cutting ● 1st Recommendation

Recommended Application	N Non-Ferrous Metal		●	
	Carbide/Hard Brittle Material	●		

Dimensions (mm)

SUMIDIA

Shape	Cat. No.	Corner Radius RE	Cutting Edge Length LE	SUMIDIA			
				DA90	DA150	DA1000	DA2200
 NF Insert	NF-TEGN 110202 110204	0.2	3.1	—	—	●	▲
		0.4	2.9	—	—	●	▲
	TEGN 110202 110204 110208	0.2	3.7	—	●	—	—
		0.4	3.6	—	●	—	—
		0.8	3.3	—	—	—	—

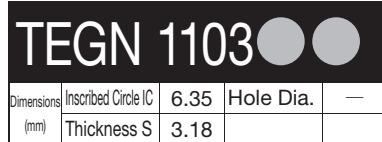

Dimensions (mm)	Inscribed Circle IC	6.35	Hole Dia.	—
	Thickness S	3.18		

Applicable Cartridge: CE type

 NF Insert	NF-TEGN 110302 110304 110308	0.2	3.1	—	—	●	▲
		0.4	2.9	—	—	●	▲
		0.8	2.7	—	—	●	▲
 NF Insert	NF-TEGN 110304P 110308P	0.4	10.4	—	—	●	▲
		0.8	9.8	—	—	●	▲
	TEGN 110302 110304 110308	0.2	3.7	—	●	—	—
		0.4	3.6	—	●	—	—
		0.8	3.3	—	—	—	—

Part number suffix P: Full-length Cutting Edge type

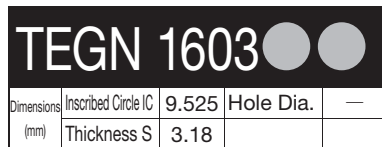

Dimensions (mm)	Inscribed Circle IC	9.525	Hole Dia.	—
	Thickness S	3.18		

Applicable Cartridge: CE type

 NF Insert	NF-TEGN 160302 160304	0.2	3.0	—	—	●	—
		0.4	2.9	—	—	●	—
 NF Insert	NF-TEGN 160304P	0.4	15.9	—	—	●	▲
	TEGN 160302 160304 160308	0.2	3.7	—	●	—	—
		0.4	3.6	—	●	●	▲
		0.8	3.3	—	—	—	—

Part number suffix P: Full-length Cutting Edge type

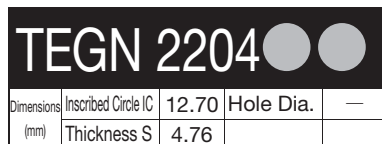

Dimensions (mm)	Inscribed Circle IC	12.70	Hole Dia.	—
	Thickness S	4.76		

Applicable Cartridge: CE type

	TEGN 220404 220408	0.4	3.6	—	●	—	—
		0.8	3.3	—	—	—	—

SUMIDIA

M

SUMIDIA
SUMIDIA
BINDERLESS

SUMICRYSTAL

C

D

S

T

V

W

SUMIDIA Inserts

Indexable Inserts



Neg.

VNMA 1604				
Dimensions (mm)	Inscribed Circle IC	9.525	Hole Dia.	3.81
	Thickness S	4.76		

Applicable External Holders C38 to C39

Neg.-Pos.

VNMX 1604				
Dimensions (mm)	Inscribed Circle IC	9.525	Hole Dia.	3.81
	Thickness S	4.76		

Applicable External Holders C38 to C39

7° Pos.

VCMW 0802				
Dimensions (mm)	Inscribed Circle IC	4.76	Hole Dia.	2.3
	Thickness S	2.38		

Applicable Internal Holders E51, E54, E57, E60

VCM 1103				
Dimensions (mm)	Inscribed Circle IC	6.35	Hole Dia.	2.8
	Thickness S	3.18		

Applicable External Holders C40 to C41, D15, D20, D28

Applicable Internal Holders E54, E57, E60

VCM 1604				
Dimensions (mm)	Inscribed Circle IC	9.525	Hole Dia.	4.4
	Thickness S	4.76		

Applicable External Holders C40 to C41

Applicable Internal Holders E54, E57

(Legend) General Cutting 1st Recommendation

Recommended Application	N Non-Ferrous Metal			
	Carbide/Hard Brittle Material			

Shape	Cat. No.	Corner Radius		Cutting Edge Length		SUMIDIA			
		RE	LE	DA90	DA150	DA1000	DA2200		
	NF-VNMA160408 160412	0.8	1.9						
		1.2	1.7						

	NF-VNMX 160402 160404 160408 160412	0.2	6.9				
		0.4	6.4				
		0.8	5.6				
		1.2	4.7				
	NU-VNMX 160402 160404 160408 160412	0.2	3.6				
		0.4	3.1				
		0.8	2.3				
		1.2	2.3				
	VNMX 160402 160404 160408 160412	0.2	6.9				
		0.4	6.4				
		0.8	5.6				
		1.2	4.7				

	NF-VCMW 080202 080204	0.2	3.2				
		0.4	2.8				

	NF-VCMW 110302 110304	0.2	3.2				
		0.4	2.8				
	NF-VCMT 110301 110302 110304	0.1	3.5				
		0.2	3.4				
		0.4	3.0				
	NF-VCMT 110302N-LD 110304N-LD	0.2	3.8				
		0.4	3.4				
	NF-VCMT 110302N-GD 110304N-GD	0.2	3.8				
		0.4	3.4				

	NF-VCMW 160402 160404 160408 160412	0.2	3.7				
		0.4	3.3				
		0.8	2.4				
		1.2	2.1				
	NF-VCMT 160404 160408 160412	0.4	6.5				
		0.8	5.6				
		1.2	4.6				

▲ mark: To be replaced by a new product, made to order, or discontinued (please confirm stock availability)

SUMIDIA Inserts

Indexable Inserts



7° Pos.

VCMT 1604

Dimensions (mm)	Inscribed Circle IC	9.525	Hole Dia.	4.4
	Thickness S	4.76		

Applicable External Holders C40 to C41

Applicable Internal Holders E54, E57

(Legend) General Cutting 1st Recommendation

Recommended Application	N Non-Ferrous Metal			
	Carbide/Hard Brittle Material			

Dimensions (mm)

SUMIDIA

Shape	Cat. No.	Corner Radius RE	Cutting Edge Length		SUMIDIA			
			LE	LE	DA90	DA150	DA1000	DA2200
 BREAK MASTER	NF-VCMT 160404N-LD	0.4	6.5	—	—		—	
	160408N-LD	0.8	5.6	—	—		—	
	160412N-LD	1.2	4.8	—	—		—	
 BREAK MASTER	NF-VCMT 160404N-GD	0.4	6.5	—	—		—	
	160408N-GD	0.8	5.6	—	—		—	
	160412N-GD	1.2	4.8	—	—		—	
	VCMT 160408	0.8	5.8	—	—			
	160412	1.2	4.9	—	—			
	160412-WF	1.2	4.9	—	—			

VCMT 2205

Dimensions (mm)	Inscribed Circle IC	12.70	Hole Dia.	5.5
	Thickness S	5.56		

Applicable External Holders C45

	VCMT 220520	2.0	5.0	—	—		
	220530	3.0	5.0	—	—		

SUMIDIA

M

SUMIDIA
SUMIDIA
BINDERLESS

SUMICRYSTAL

C

D

S

T

V

W

SUMIDIA Inserts

Indexable Inserts



5° Pos.

WBMT 0601			
Dimensions (mm)	Inscribed Circle IC	Hole Dia.	Thickness S
	3.97	2.2	1.59

Applicable Internal Holders E62

(Legend) General Cutting 1st Recommendation

Recommended Application	N Non-Ferrous Metal			
Recommended Application	Carbide/Hard Brittle Material			

Shape	Cat. No.	Corner Radius RE	Cutting Edge Length LE	SUMIDIA			
				DA90	DA150	DA1000	DA2200
 NF Insert	NF-WBMT 060101L	0.1	1.8				
	060102L	0.2	1.8				
	060104L	0.4	1.7				
 WBMT	WBMT 060101L	0.1	1.8				
	060102L	0.2	1.8				
	060104L	0.4	1.7				

SUMIDIA
M
SUMIDIA
BINDERLESS

SUMICRYSTAL

C

D

S

T

V

W

▲ mark: To be replaced by a new product, made to order, or discontinued (please confirm stock availability)

SUMIDIA Inserts

Indexable Inserts



For Turning

Round Insert

Shape	Cat. No.	SUMIDIA				Inscribed Circle IC	Thickness S	Cutting Edge Length LE	Corner Radius RE	Hole Dia.	Fig	Applicable Holder
		DA90	DA150	DA1000	DA2200							
	RPGW 0803M0			●	▲	8.0	3.18	—	—	3.3	1	Al. Wheel Turning Holder SEC-RP Profiling Holder (RP02 series) (Made-to-order item)
	RPGT 0803M0-WF					8.0	3.18	—	—	3.3	2	

Part number suffix WF: Edge with Special Land for Aluminum Wheel Gloss Finishing

Dogbone Insert

Shape	Cat. No.	SUMIDIA				Overall Length L	Thickness S	Corner Radius RE	Fig	Applicable Holder
		DA90	DA150	DA1000	DA2200					
	MDE 3R				●	26	8.5	3.0	1	Al. Wheel Turning Holder SEC-GD Profiling Holder (GDE series) → C46 to C47
	4R				●	30	8.5	4.0	1	
	MDE 3R-AW				●	26	8.5	3.0	1	
	4R-AW				●	30	8.5	4.0	1	

Very Small Dia. Boring Insert

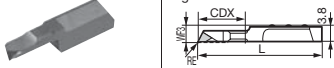
Shape	Cat. No.	SUMIDIA				Min. Bore Dia. DMIN	WF3	Corner Radius RE	L	CDX	Fig	Applicable Holder
		DA2200										
	KBMX R0311-10	●				3.0	4.1	0.1	28.5	11.0	1	Very Small Dia. Boring Bar (CKB series) → M30
	R0411-10	●				4.0	4.3	0.1	28.5	11.0	1	
	R0511-10	●					5.0	4.5	0.1	28.5	11.0	

Grooving Insert

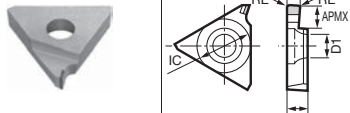
Shape	Cat. No.	DA2200		Inscribed Circle IC	Width of Cut CW	Corner Radius RE	Maximum Groove Depth APMX	Hole Dia. D1	Fig	Applicable Holder
		R	L							
	TGA R/L4125	●		12.70	1.25	0.1	2.0	5.5	1	SEC-Grooving Tools (GWC series, GWCS series, GWCI series) → F4 to F5
	R/L4150	●		12.70	1.50	0.1	3.5	5.5	1	
	R/L4200	●		12.70	2.00	0.1	3.5	5.5	1	
	R/L4250	●		12.70	2.50	0.1	4.0	5.5	1	
	R/L4300	●		12.70	3.00	0.1	4.0	5.5	1	
	R/L4350	●		12.70	3.50	0.1	5.0	5.5	1	
	R/L4400	●		12.70	4.00	0.1	5.0	5.5	1	

For Milling

For SEC-ACE MILL APG series

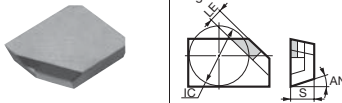
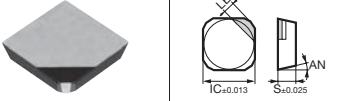
Shape	Cat. No.	SUMIDIA			Inscribed Circle IC	Thickness S	Cutting Edge Length LE	Relief Angle AN	Fig	Applicable Cutter/Endmill
		DA150	DA1000	DA2200						
	APW 4R		●	▲	12.70	3.18	2.0	15	1	APG series → H48
	5R				15.875	4.76	2.0	15	1	
	NF-SDC 42R	—	●	▲	12.70	3.18	3.0	15	1	
	SDC 42R	●	●	▲	12.70	3.18	3.0	15	1	
	SDC 53R				15.88	4.76	3.0	15	1	

For SEC-ACE MILL FPG series / SEC-Multi Use Endmill FPE series

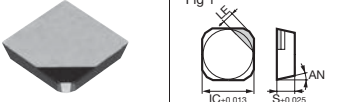
Shape	Cat. No.	SUMIDIA			Inscribed Circle IC	Thickness S	Cutting Edge Length LE	Relief Angle AN	Fig	Applicable Cutter/Endmill
		DA150	DA1000	DA2200						
	NF-SDKN 42M	—	●	▲	12.70	3.18	3.0	15	1	FPG series → H40 FPE series → H41
	SDKN 42M	●			12.70	3.18	3.0	15	1	
	SDKN 53M				15.88	4.76	3.0	15	1	

SUMIDIA

M

SUMIDIA
SUMIDIA
BINDERLESS

SUMICRYSTAL

C

D

S

T

V

W

For Milling

For SUMIDIA Cutter FAM series / SAM series

Shape	Cat. No.	SUMIDIA						SUMICRYSTAL		Dimensions (mm)			Applicable Cutter / Endmill
		DA90	DA150	DA1000	DA2200	SC10*1	SCV10*1	Inscribed Circle	Thickness	Cutting Edge Length	Relief Angle	Fig	
	FAB R L	—	▲	—	▲	—	—	—	7.9	(5.8)	15	1	FAM series →M54
	SAB R L	—	▲	—	▲	—	—	—	7.9	(5.7)	15	2	
		—	—	—	—	—	—	—	7.9	(5.7)	15	2	SAM series →M54 to M55

For SEC-ACE MILL CHG series / SEC-Multi Use Endmill CHE series

	NF-TEEN 22R 32R 43R	—	—	●	▲	—	—	6.35	3.18	4.9	20	1	CHG series →H156 CHE series →H157 to H159
		—	—	●	▲	—	—	9.525	3.18	4.9	20	1	
		—	—	●	▲	—	—	12.70	4.76	4.8	20	1	
	TEEN 22R 32R 43R	—	●	—	—	—	—	6.35	3.18	4.9	20	1	
		—	●	—	—	—	—	9.525	3.18	4.9	20	1	
		—	●	—	—	—	—	12.70	4.76	4.8	20	1	

For High-efficiency Cutter for Aluminum Alloys ALNEX ANX series (Blade)

	ANB 1600R-L 1600R-G 1600R-GB 1600R-H	—	—	●	—	—	—	—	—	6.0	—	1	ANX series →M32 to M42
		—	—	●	—	—	—	—	—	6.0	—	1	
		—	—	●	—	—	—	—	—	6.0	—	1	
		—	—	●	—	—	—	—	—	6.0	—	1	
	ANB 1600R-GX ANB 1604R 1608R ANB 1600R-W ANB 1600R-WS ANBD	—	—	●	—	—	—	—	—	9.0	—	2	
		—	—	●	—	—	—	—	—	6.0	—	3	
		—	—	●	—	—	—	—	—	6.0	—	3	
		—	—	●	—	—	—	—	—	—	—	4	
—	—	—	—	—	●	—	—	—	—	—	5		
—	—	—	—	—	●	—	—	—	—	—	6		

For High-efficiency Cutter for Aluminum Alloys HF series (Blade)

	NF-LDEN 12T3ZDFR-L 12T3ZDFR-G 12T3ZDFR-H	—	—	●	—	—	—	—	—	6.0	—	1	HF series →M44 to M49
		—	—	●	—	—	—	—	—	6.0	—	1	
		—	—	●	—	—	—	—	—	6.0	—	1	
	NF-LDEN 12T3ZDFR-GX NF-LDEN 12T3ZDFR-W	—	—	●	—	—	—	—	—	9.0	—	2	
		—	—	●	—	—	—	—	—	—	—	3	

For High-Speed Cutter for Aluminum Alloys RF series (Insert)

	NF-SNEW 1204ADFR 120404ADFR-H NF-SNEW 1204ADFR-W SNEW 1204ADFR-WS	—	—	●	▲	—	—	12.70	4.76	4.7	15	1	RF series →M50 to M51
		—	—	●	▲	—	—	12.70	4.76	9.5	15	1	
		—	—	●	▲	—	—	12.70	4.76	2.3	15	2	
		—	—	—	—	●	—	12.70	4.76	1.0	20	2	

For High-Speed Cutter for Aluminum Alloys RF series (Blade)

	RFB RFBW	—	—	●	—	—	—	—	—	6.5	—	1	RF series →M50 to M51
		—	—	●	—	—	—	—	—	4.5	—	2	

For Small Diameter Cutter for Aluminum Alloys SRF series

	NF-SNEW 09T3ADTR NF-SNEW 09T3ADTR-U NF-SNEW 09T3ADTR-R	—	—	●	▲	—	—	9.525	3.96	6.0	15	1	SRF series →M52 to M53
		—	—	●	▲	—	—	9.525	3.96	6.0	15	2	
		—	—	●	▲	—	—	9.525	3.96	6.0	15	3	
		—	—	—	—	—	—	—	—	—	—	—	

For SEC-WaveMill WGC series

	NF-SECW13T3AGTN-N	—	—	●	▲	—	—	13.40	3.97	2.1	20	1	WGC series →H26 to H28
		—	—	●	▲	—	—	13.40	3.97	2.5	20	1	
	NF-XEEW13T3AGFR-W	—	—	●	▲	—	—	13.40	3.97	2.5	20	1	WGC series →H26 to H28

*1: SC10 is SUMICRYSTAL and SCV10 is CVD single-crystal diamond *2: Dummy blade for use with WS type (cemented carbide)

● mark: Standard stocked item (new product/expanded item) ▲ mark: To be replaced by a new product, made to order, or discontinued (please confirm stock availability)

SUMIDIA
M
SUMIDIA
BINDERLESS

SUMICRYSTAL

C

D

S

T

V

W

SUMIDIA/SUMIDIA BINDERLESS Inserts

Indexable Inserts

SUMIDIA BINDERLESS NPD10 Neg.

(Legend) Continuous Cutting ● 1st Recommendation

Shape	Cat. No.	NPD10	Dimensions (mm)				
			Cutting Edge Length	Inscribed Circle IC	Thickness S	Hole Dia. D1	Corner Radius RE
	DNMA 150408RH	●	1.8	12.7	4.76	5.16	0.8
	150412RH	●	1.8	12.7	4.76	5.16	1.2
	SNMA 120408RH	●	1.7	12.7	4.76	5.16	0.8
	120412RH	●	1.7	12.7	4.76	5.16	1.2
	VNMA 160408RH	●	1.8	9.525	4.76	3.81	0.8
	160412RH	●	1.5	9.525	4.76	3.81	1.2

SUMIDIA DA90 Neg. NF

(Legend) General Cutting ● 1st Recommendation

Shape	Cat. No.	DA90	Dimensions (mm)				
			Cutting Edge Length	Inscribed Circle IC	Thickness S	Hole Dia. D1	Corner Radius RE
	NF-DNMA 150408	●	2.0	12.7	4.76	5.16	0.8
	150412	●	2.0	12.7	4.76	5.16	1.2
	NF-SNMA 120408	●	2.4	12.7	4.76	5.16	0.8
	120412	●	2.4	12.7	4.76	5.16	1.2
	NF-VNMA 160408	●	1.9	9.525	4.76	3.81	0.8
	160412	●	1.7	9.525	4.76	3.81	1.2

Pos.

(Legend) Continuous Cutting ● 1st Recommendation

Shape	Relief Angle	Cat. No.	NPD10	Dimensions (mm)				
				Cutting Edge Length	Inscribed Circle IC	Thickness S	Hole Dia. D1	Corner Radius RE
	7°	CCMW 03X102RH	●	1.3	3.5	1.4	1.9	0.2
		03X104RH	●	1.3	3.5	1.4	1.9	0.4
	7°	CCMW 04X102RH	●	1.7	4.3	1.8	2.3	0.2
		04X104RH	●	1.7	4.3	1.8	2.3	0.4
	7°	CCMW 060202RH	●	1.7	6.35	2.38	2.8	0.2
		060204RH	●	1.7	6.35	2.38	2.8	0.4
	7°	CCMW 09T302RH	●	1.7	9.525	3.97	4.4	0.2
		09T304RH	●	1.7	9.525	3.97	4.4	0.4
	7°	CCMW 09T308RH	●	1.6	9.525	3.97	4.4	0.8
		DCMW 070202RH	●	2.1	6.35	2.38	2.8	0.2
	7°	DCMW 070204RH	●	2.0	6.35	2.38	2.8	0.4
		DCMW 11T302RH	●	2.1	9.525	3.97	4.4	0.2
	7°	DCMW 11T304RH	●	1.9	9.525	3.97	4.4	0.4
		DCMW 11T308RH	●	1.6	9.525	3.97	4.4	0.8
	11°	TPMW 080202RH	●	1.2	4.76	2.38	2.3	0.2
		TPMW 080204RH	●	1.0	4.76	2.38	2.3	0.4
	11°	TPMW 110302RH	●	1.5	6.35	3.18	3.4	0.2
		TPMW 110304RH	●	1.3	6.35	3.18	3.4	0.4
	11°	TPMW 110308RH	●	1.0	6.35	3.18	3.4	0.8
		TPMW 160402RH	●	2.2	9.525	4.76	4.4	0.2
	7°	TPMW 160404RH	●	2.0	9.525	4.76	4.4	0.4
		TPMW 160408RH	●	1.6	9.525	4.76	4.4	0.8
	7°	TPMW 160412RH	●	1.6	9.525	4.76	4.4	0.8
		VCMW 080201RH	●	2.2	4.76	2.38	2.3	0.1
	7°	VCMW 080202RH	●	1.9	4.76	2.38	2.3	0.2
		VCMW 080204RH	●	1.5	4.76	2.38	2.3	0.4
	7°	VCMW 110302RH	●	2.1	6.35	3.18	2.8	0.2
		VCMW 110304RH	●	1.7	6.35	3.18	2.8	0.4
	7°	VCMW 160402RH	●	2.1	9.525	4.76	4.4	0.2
		VCMW 160404RH	●	1.7	9.525	4.76	4.4	0.4
	7°	VCMW 160408RH	●	1.8	9.525	4.76	4.4	0.8
		VCMW 160412RH	●	1.5	9.525	4.76	4.4	1.2

Pos. NF

(Legend) General Cutting ● 1st Recommendation

Shape	Relief Angle	Cat. No.	DA90	Dimensions (mm)				
				Cutting Edge Length	Inscribed Circle IC	Thickness S	Hole Dia. D1	Corner Radius RE
	7°	NF-CCMW 03X102	●	1.1	3.5	1.4	1.9	0.2
		NF-CCMW 03X104	●	1.1	3.5	1.4	1.9	0.4
	7°	NF-CCMW 04X102	●	1.5	4.3	1.8	2.3	0.2
		NF-CCMW 04X104	●	1.5	4.3	1.8	2.3	0.4
	7°	NF-CCMW 060202	●	2.4	6.35	2.38	2.8	0.2
		NF-CCMW 060204	●	2.4	6.35	2.38	2.8	0.4
	7°	NF-CCMW 09T302	●	2.4	9.525	3.97	4.4	0.2
		NF-CCMW 09T304	●	2.4	9.525	3.97	4.4	0.4
	7°	NF-CCMW 09T308	●	2.3	9.525	3.97	4.4	0.8
		NF-DCMW 070202	●	2.6	6.35	2.38	2.8	0.2
	7°	NF-DCMW 070204	●	2.4	6.35	2.38	2.8	0.4
		NF-DCMW 11T302	●	2.6	9.525	3.97	4.4	0.2
	7°	NF-DCMW 11T304	●	2.4	9.525	3.97	4.4	0.4
		NF-DCMW 11T308	●	2.0	9.525	3.97	4.4	0.8
	11°	NF-TPMW 080202	●	2.5	4.76	2.38	2.3	0.2
		NF-TPMW 080204	●	2.4	4.76	2.38	2.3	0.4
	11°	NF-TPMW 110302	●	2.5	6.35	3.18	3.4	0.2
		NF-TPMW 110304	●	2.4	6.35	3.18	3.4	0.4
	11°	NF-TPMW 110308	●	2.1	6.35	3.18	3.4	0.8
		NF-TPMW 160402	●	2.5	9.525	4.76	4.4	0.2
	7°	NF-TPMW 160404	●	2.4	9.525	4.76	4.4	0.4
		NF-TPMW 160408	●	2.1	9.525	4.76	4.4	0.8
	7°	NF-TPMW 160412	●	2.1	9.525	4.76	4.4	1.2
		NF-VCMW 080202	●	3.2	4.76	2.38	2.3	0.2
	7°	NF-VCMW 080204	●	2.8	4.76	2.38	2.3	0.4
		NF-VCMW 110302	●	3.2	6.35	3.18	2.8	0.2
	7°	NF-VCMW 110304	●	2.8	6.35	3.18	2.8	0.4
		NF-VCMW 160402	●	3.7	9.525	4.76	4.4	0.2
	7°	NF-VCMW 160404	●	3.3	9.525	4.76	4.4	0.4
		NF-VCMW 160408	●	2.4	9.525	4.76	4.4	0.8
	7°	NF-VCMW 160412	●	2.1	9.525	4.76	4.4	1.2

The R portion of the cutting edge is cylindrical shaped.

Page for Applicable Holders

Cat. No.	Applicable Holder	Cat. No.	Applicable Holder	Cat. No.	Applicable Holder
(NF-) DNMA1504●●(RH)	C14 to C16 E15, E31 to E33	(NF-) CCMW03X1●●(RH)	E18, E20	(NF-) TPMW0802●●(RH)	E42 to E45
(NF-) SNMA1204●●(RH)	C21 to C26 E39 to E41	(NF-) CCMW04X1●●(RH)	E18, E20	(NF-) TPMW1103●●(RH)	E14, E42 to E46
(NF-) VNMA1604●●(RH)	C38 to C39	(NF-) CCMW0602●●(RH)	C13, D13, D17, D22, D23 E18 to E20	(NF-) TPMW1604●●(RH)	E14, E42 to E44
		(NF-) CCMW09T3●●(RH)	C13, D13, D17, D22, D23 E18, E18 to E20	(NF-) VCMW0802●●(RH)	E51, E54, E57, E60
		(NF-) DCMW0702●●(RH)	C19, D14, D18, D19, D24, D25 E16, E26 to E30	(NF-) VCMW1103●●(RH)	E54, E57, E60
		(NF-) DCMW11T3●●(RH)	C19, D14, D18, D19, D24, D25 E26 to E30	(NF-) VCMW1604●●(RH)	E54, E57

External Turning Internal Boring



■ Features

- Enables high-efficiency roughing of long parts
- Coin-shaped chips are less likely to tangle with work material or machinery



■ Application Examples

LD type + DA1000

Conventional Tool

Work Material: Valve (A6061) Tool Cat. No.: KGV R2004-LD (DA1000)
Cutting Conditions: $vc = 250\text{m/min}$, $f = 0.10\text{mm/rev}$, $ap = 0.5\text{mm}$ Wet

■ SUMIDIA Multi-Function Tool with Chipbreaker SUMIDIA BREAK MASTER LD type

- Provides excellent chip control in traverse cutting and grooving of aluminum alloy.
- Solves chip control problems and dramatically improves work efficiency.
- Achieves long, stable tool life by employing high-toughness grade SUMIDIA DA1000.

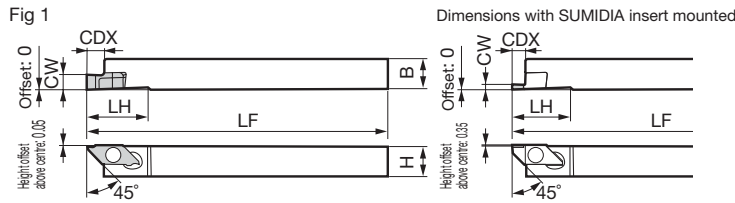
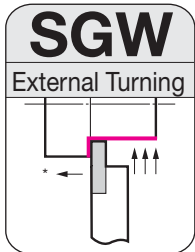

External Multi-purpose type (Grooving/Traverse Cutting) Screw-on

*Use the SUMIDIA insert for traverse cutting.

Holder

Cat. No.	Stock	Height H	Width B	Overall Length LF	Maximum Groove Depth CDX	Head Length LH	Fig	Parts	
								Flat Insert Screw	Wrench
SGW R1212	●	12	12	120	7.0	24.5	1	BFTX0410T8R	1.1
SGW R1616	●	16	16	120	7.0	24.5	1	TRX08	(For Torx hole)

The above dimensions for LF, CDX and LH are values with a carbide insert mounted. (Refer to the table below for dimensions with SUMIDIA insert mounted)

Insert (Carbide) (Coated Carbide)

Cat. No.	AC1030U	AC530U	Width of Cut CW	Overall Length L	Overall Length LF	Maximum Groove Depth CDX	Head Length LH	Effective Length	Fig
KGV R500	●	●	5.0	21.0	120	7.0	24.5	6.3	1
KGV R600	●	●	6.0	21.0	120	7.0	24.5	6.3	1

Insert (SUMIDIA) (SUMIDIA)

Cat. No.	DA1000	Width of Cut CW	Overall Length L	Overall Length LF	Maximum Groove Depth CDX	Head Length LH	Effective Length	Fig
KGV R2504-LD	●	2.5	19.7	118.7	5.0	23.2	4.0	1
KGV R2506-LD	●	2.5	21.2	120.2	6.5	24.7	5.5	1

The above dimensions for LF, CDX and LH are the holder dimensions with insert mounted.

Note: The values in red (maximum groove depth CDX) have been changed from those in the 2021-2022 General Catalogue.

Recommended Cutting Conditions

Work Material	P Steel	M Stainless Steel	N Non-Ferrous Metal	N Non-Ferrous Metal
Insert Grades	AC1030U			DA1000
Machining Details	Grooving			Grooving / Traverse Cutting
Spindle Speed n (min ⁻¹)	4,000 to 6,000			4,500 to 8,000
Feed Rate f (mm/rev)	0.05 to 0.15			0.07 to 0.15
Coolant	Wet (oil-based)			

Be careful with spindle power during use. For small lathes, insufficient spindle power during machining may cause the machine to stop.
Be careful when machining carbon steel and stainless steel in particular.

Recommended tightening torque (N-m) Note: Regrinding the SUMIDIA BREAK MASTER LD type will adversely affect chip evacuation performance.

CKB series

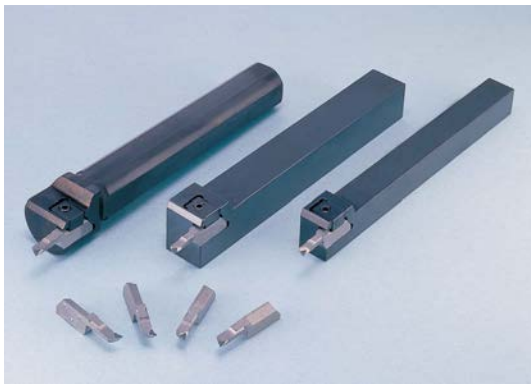

■ Features

- High indexing accuracy with simple structure design and one-touch clamping.
- Utilises DA2200 grade with excellent edge sharpness.

■ Insert

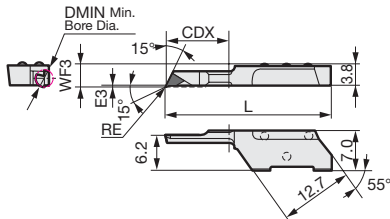

(SUMIDIA)

Dimensions (mm)

Cat. No.	DA2200	Min. Bore Dia. DMIN	Cutting Edge Position WF3	Offset E3	Corner Radius RE	Overall Length L	Depth of Cut CDX
KBMX R0311-10	●	3.0	4.1	0.3	0.1	28.5	11
KBMX R0411-10	●	4.0	4.3	0.5	0.1	28.5	11
KBMX R0511-10	●	5.0	4.5	0.7	0.1	28.5	11

■ Square Shank Fig 1

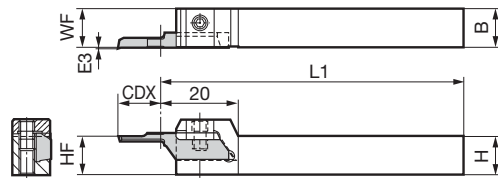

For E3 and CDX, refer to the insert section

Parts

Holder

Cat. No.	Stock	Dimensions (mm)					Fig	Clamp Plate	Double Screw	Wrench
		Height H	Width B	Overall Length L1	Cutting Edge Distance WF	Cutting Edge Height HF				
CKB R1010-16	●	10	10	100	10	10	1	CKBW16	WB4-8	LH020
CKB R1212-16	●	12	12	125	12	12	1			
CKB R1616-16	●	16	16	125	16	16	1			
CKB R2020-16	●	20	20	125	20	20	1			
CKB R2525-16	●	25	25	150	25	25	1			

*Inserts are not included in the tool holders

■ Round Shank

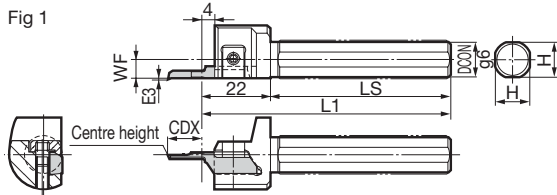

For E3 and CDX, refer to the insert section

Fig. 2 (Small offset type)

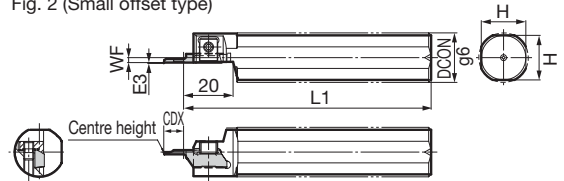

Parts

Holder

Cat. No.	Stock	Dimensions (mm)					Fig	Clamp Plate	Double Screw	Wrench
		Diameter DCON	Height H	Overall Length L1	Length LS	Cutting Edge Distance WF				
S10F-CKB R-16	●	10	9	80	58	5	1	CKBW16	WB4-8	LH020
S12F-CKB R-16	●	12	11	80	58	6	1			
S16H-CKB R-16	●	16	15	100	78	8	1			
S19K-CKB R-16	●	19.05	17	125	103	8	1			
S20K-CKB R-16	●	20	18	125	103	10	1			
S1905H-CKB RS-16	●	19.05	17	100	—	2	2			
S20H-CKB RS-16	●	20	18	100	—	2	2			
S22K-CKB RS-16	●	22	19	125	—	2	2			
S25K-CKB RS-16	●	25	23	125	—	2	2			
S254K-CKB RS-16	●	25.4	23	125	—	2	2			

*Inserts are not included in the tool holders

■ Recommended Cutting Conditions

Work Material	Spindle Speed	Depth of Cut ap	Feed Rate f	Coolant
N Aluminum Alloy	Above 2,000 min ⁻¹	0.1mm or below	0.1mm/rev or below	Wet

SUMIDIA

M

SUMIDIA
SUMIDIA
BINDERLESS

SUMICRYSTAL

C

D

S

T

V

W

DABB series

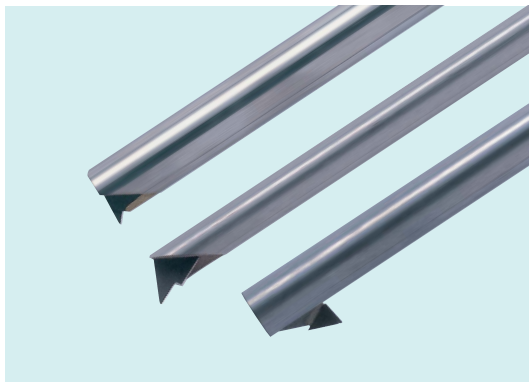

■ Features

- Small Diameter Boring Bars for Aluminum Alloy
Three types are in stock, enabling a range of machining from general boring to necking and back turning. $\phi 3.0$ mm minimum machining diameter
- Utilises High Strength PCD Grade DA2200 for Cutting Edge

For general boring with min. bore diameter $\phi 10$ to $\phi 22$ mm range, use the BNB series small diameter boring bar + SUMIDIA Insert (See page L126 for details)



PCD

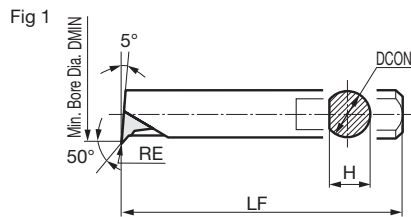
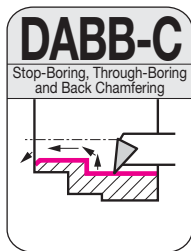

Holder (SUMIDIA)

Dimensions (mm)

Cat. No.	DA2200	Min. Bore Dia. DMIN	Diameter DCON	Height H	Overall Length LF	Corner Radius RE	Applicable Sleeve	Fig
DABB 025CR	●	3.0	2.5	2.2	60	0.1	HBB 2516	1
DABB 035CR	●	4.0	3.5	3.2	60	0.1	HBB 3516	1
DABB 045CR	●	5.0	4.5	4.1	80	0.1	HBB 4516	1
DABB 060CR	●	7.0	6.0	5.2	80	0.1	HBB 616	1

PCD

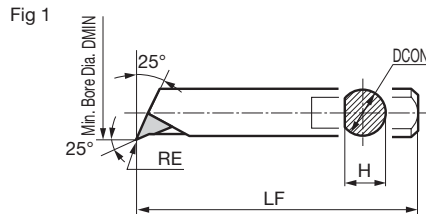
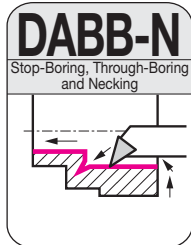

Holder (SUMIDIA)

Dimensions (mm)

Cat. No.	DA2200	Min. Bore Dia. DMIN	Diameter DCON	Height H	Overall Length LF	Corner Radius RE	Applicable Sleeve	Fig
DABB 025NR	●	3.0	2.5	2.2	60	0.1	HBB 2516	1
DABB 035NR	●	4.0	3.5	3.2	60	0.1	HBB 3516	1
DABB 045NR	●	5.0	4.5	4.1	80	0.1	HBB 4516	1
DABB 060NR	●	7.0	6.0	5.2	80	0.1	HBB 616	1

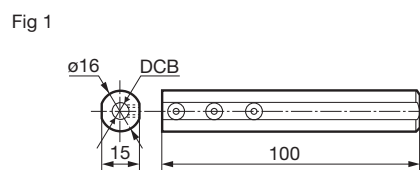

Sleeve

Dimensions (mm)

Cat. No.	Stock	Bore Dia. DCB	Fig	Set Screw	Wrench
					 (For Hexagonal hole)
HBB 2516	●	2.5	1		
HBB 3516	●	3.5	1		
HBB 4516	●	4.5	1	BT0404	LH020
HBB 616	●	6.0	1		

HBX type sleeve can also be used.

■ Recommended Cutting Conditions

Work Material	Spindle Speed	Depth of Cut ap	Feed Rate f	Coolant
N Aluminum Alloy	Above 2,000 min ⁻¹	0.1mm or below	0.1mm/rev or below	Wet

SUMIDIA

M

SUMIDIA SUMIDIA BINDERLESS

SUMICRYSTAL

C

D

S

T

V

W



■ Features

- **Drastically Reduced Runout Adjustment Time**
Simple screw-fastening structure enables fine adjustments to be made easily
- **Through-Blade Coolant**
Ensures coolant supply to the cutting edge and breaks chips
- **Lightweight Aluminum Alloy Body (ANXA type)**
Utilises aluminum alloy to achieve a total weight of less than 1.3kg for a ø125mm cutter with 22 teeth
- **Introducing the High-strength CVD Single Crystal Diamond SCV10 Wiper Blade WS type**

■ Product Range

Type	Cat. No.	Body Material	Max. Diameter (mm)																			
			ø25	ø30	ø32	ø40	ø50	ø63	ø80	ø100	ø125	ø160										
Shell	ANXA 16000R Inch	Aluminum Alloy								6	10	14	8	12	18	10	14	22	12	20	28	
	ANXA 16000RS	Aluminum Alloy								6	10	14	8	12	18	10	14	22	12	20	28	
	ANXS 16000R Inch	Steel								6	8	12	6	10	14	8	12	18	10	14	22	
	ANXS 16000RS	Steel				4	6	4	6	9	6	8	12	6	10	14	8	12	18	10	14	22
Shank	ANXS 16000E	Steel	2	3	4	3	4	4	6	4	6	9										
Modular	ANXS 16000M	Steel	2	3	4	3	4	4	6													

Number in ●●● shows the number of teeth Inch Bore

Modular type M42

■ Blade Selection Guide

Work Material	N								
Applications	Finishing/Light Cutting	General-purpose	Roughing		Composite Milling *1	Corner Radius Milling	Corner Radius Milling	Finishing	Burr-free Mirror Finish
Features	Low Cutting Force	Standard	Long Edge	High Strength	High Strength	Corner Radius 0.4	Corner Radius 0.8	Wiper	Wiper
Cutting Edge Shape	L	G	GX	H	GB			W	WS
Edge Length (*2)	6.0mm	6.0mm	9.0mm	6.0mm	6.0mm	6.0mm	6.0mm	2.0mm	1.0mm

*1 Machining of components combining aluminum alloy and cast iron. W type and WS type cannot be used together.

■ Blade Selection Reference

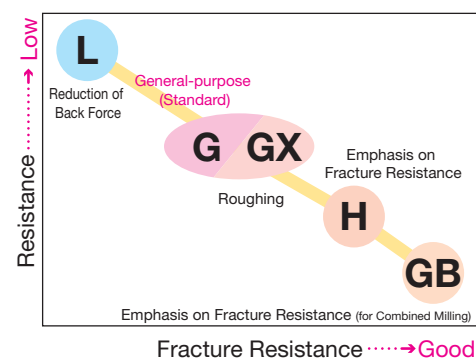

● Regrinding possible up to 1.0mm. Reduced running costs

Assuming 0.2mm of regrinding each time, an edge can be used up to 6 times. (Peripheral cutting edge and WS type cannot be reground.)

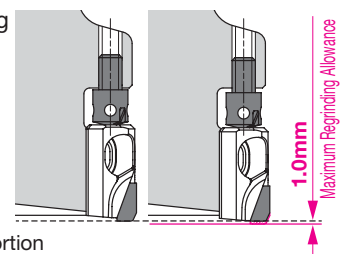
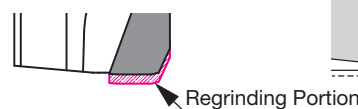

■ High-speed/High-efficiency Cutting

Realises ultra-high-efficiency machining with $vf = 30,000\text{mm/min}$



Cutter diameter ø100mm comparison

	Spindle Speed min^{-1}	Number of Teeth	Feed Rate $vf(\text{mm/min})$
ALNEX ANX series	18,000	18	32,400
Competitor's Product A	9,500	12	11,400

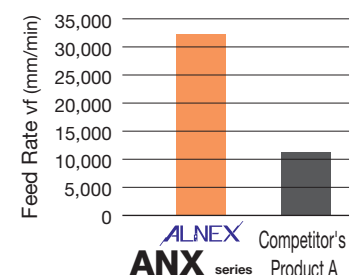

New CVD Single Crystal Diamond SCV10 Wiper Blade WS type

- Wiper blade adopts high-strength single-crystal diamond using Sumitomo Electric Hardmetal's vapour phase synthesis technology
- Sharp cutting edge achieves burr-free mirror finish in aluminum alloy machining
- Superior wear resistance maintains cutting edge sharpness for a long time, reducing total tool costs



Conventional single-crystal diamond



Superb mirror surface and burr control through sharp cutting edge

Realizes a mirror finish in milling of aluminum alloys, copper alloys, and other non-ferrous metals, with long-term burr control

Mirror Finish (Wiper Blade WS type)

Sharp cutting edge achieves mirror finish with cutting alone

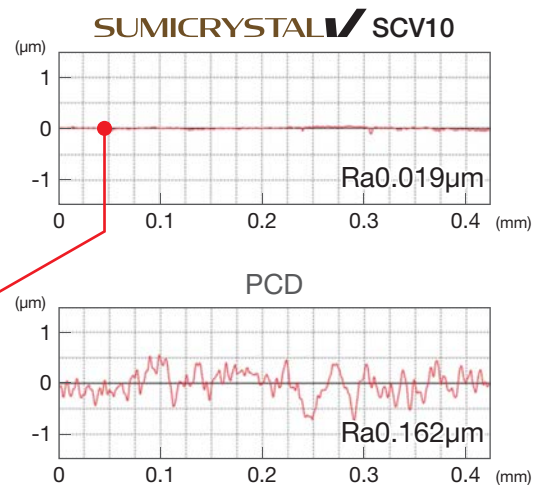
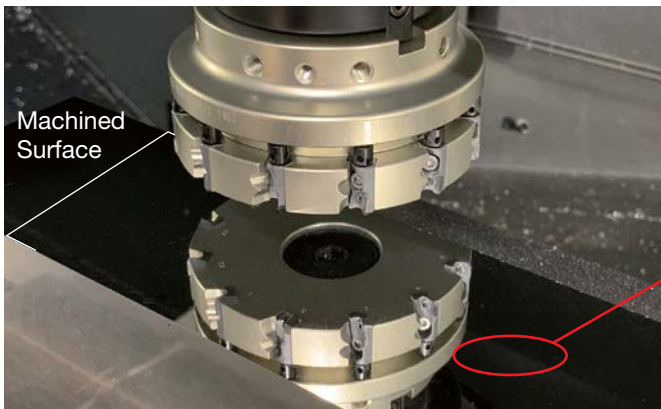

Burr-Free (Wiper Blade WS type)

Sharp cutting edge and excellent wear resistance suppress burrs over a long period

Relative Tool Life (%)

*When using 2-tooth WS type

Extension Possible

Tool life criteria: Burr suppression 5x or longer tool life

Tool life criteria: Burr

Tool: ANXS16100R12
When using 2-tooth wiper blade
Work Material: A7075
Cutting Conditions:
vc = 2,000m/min
fz = 0.05mm/t
ap = 0.1mm
Wet (water soluble)

Burr-free

Edge Burr

SUMICRYSTAL SCV10

PCD (PCD as 100%)

SUMIDIA

M

SUMIDIA
SUMIDIA
BINDERLESS

SUMICRYSTAL

C

D

S

T

V

W

◆ Superior wear resistance maintains cutting edge sharpness for a long time

Wear resistance evaluation in high-silicon aluminum alloy machining

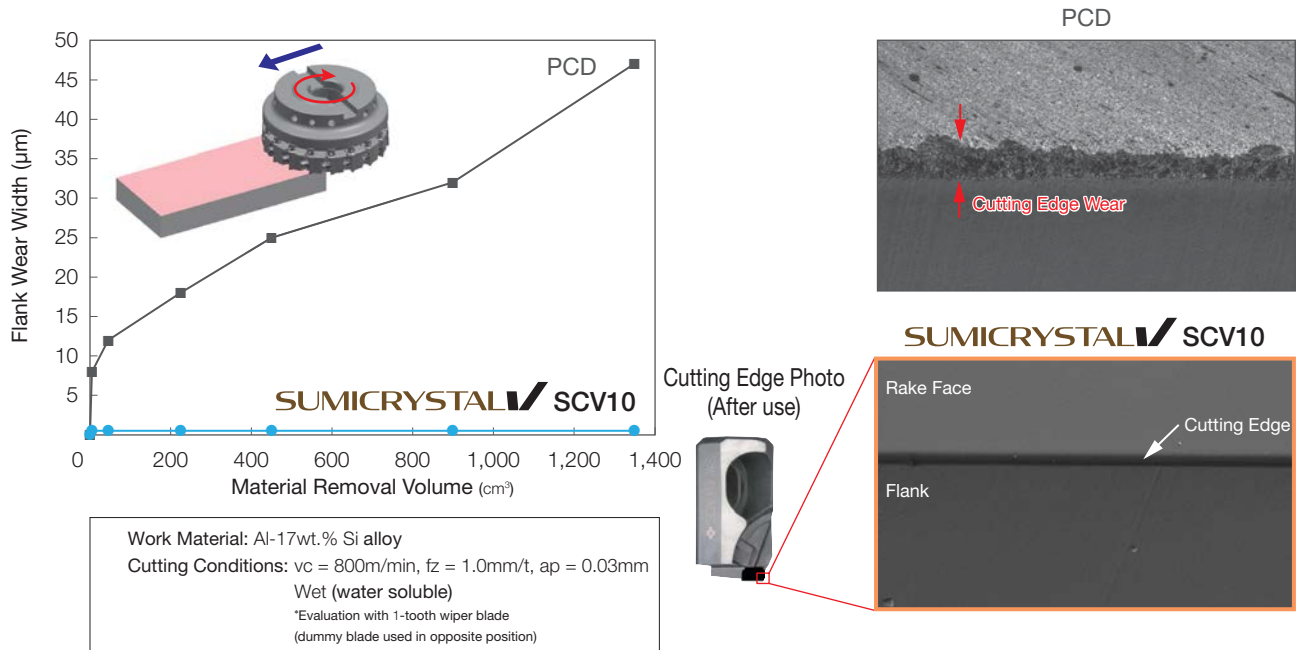

Long-term mirror finish with burrs suppressed and no flank wear progress

◆ Jet-black high-strength single-crystal diamond grade

Fracture resistance evaluation in aluminum alloy-ceramic composite machining

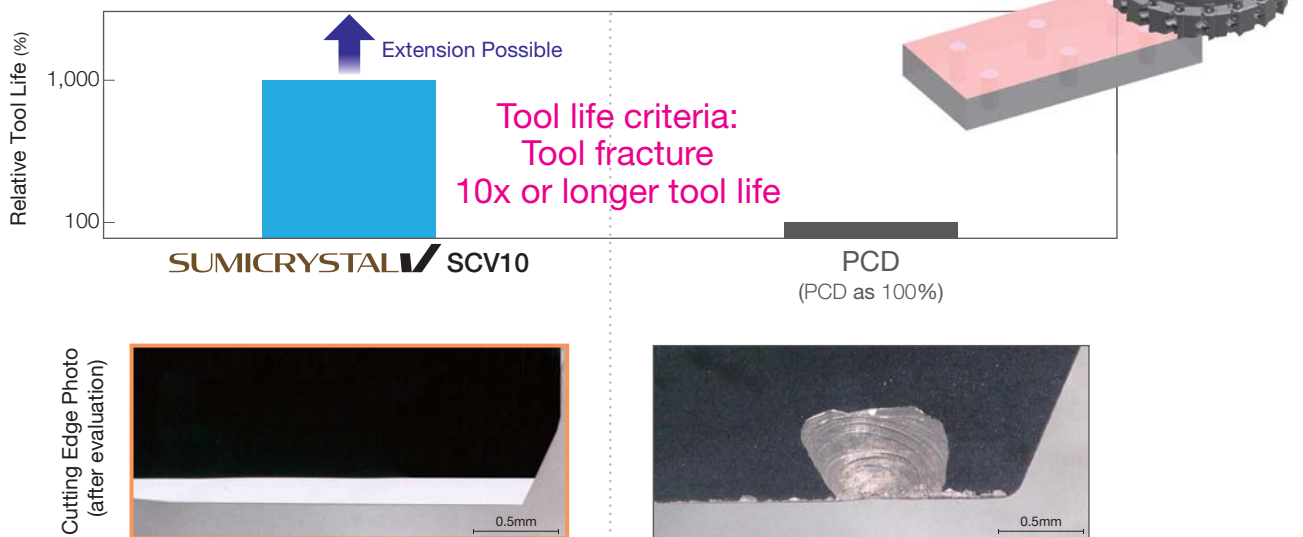

Work Material: Aluminum Alloy + Ceramic Composite
 Cutting Conditions: $v_c = 2,500\text{m/min}$, $f_z = 1.0\text{mm/t}$, $a_p = 0.03\text{mm}$
 Wet (water soluble)
 *Evaluation with 1-tooth wiper blade (dummy blade used in opposite position)

10x or more fracture resistance compared to PCD in finishing at low depth of cut (0.05 mm or less)

ANXA 16000R(S) type

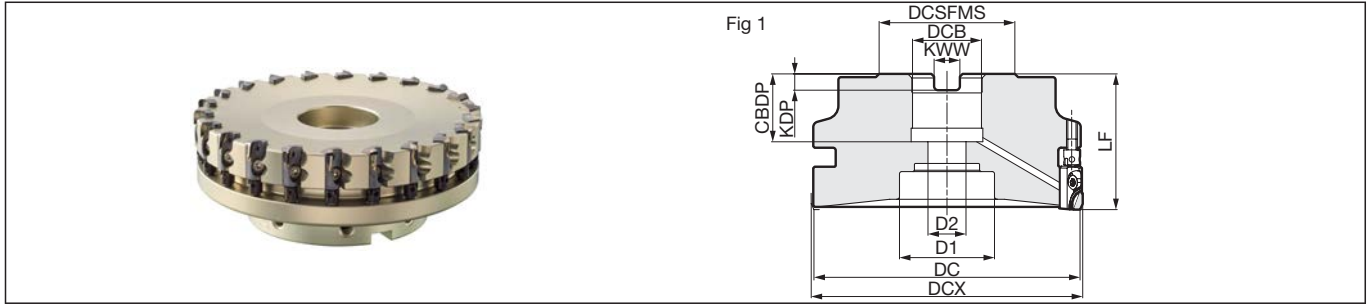

Body (Aluminum Alloy)

Dimensions (mm)

Cat. No.	Stock	Max. Dia. DCX	Dia. DC	Boss Dia. DCSFMS	Overall Length LF	Hole Dia. DCB	Keyway Width KWW	Keyway Depth KDP	Mounting Depth CDBP	Bolt D1	Bolt D2	Number of Teeth	Weight (kg)	Fig
ANXA 1608RS06	●	80	78	50	50	27	12.4	7	22	35	14	6	0.5	1
1608RS10	●	80	78	50	50	27	12.4	7	22	35	14	10	0.5	1
1608RS14	●	80	78	50	50	27	12.4	7	22	35	14	14	0.5	1
16100RS08	●	100	98	50	50	27	12.4	7	22	35	14	8	0.8	1
16100RS12	●	100	98	50	50	27	12.4	7	22	35	14	12	0.8	1
16100RS18	●	100	98	50	50	27	12.4	7	22	35	14	18	0.8	1
16125RS10	●	125	123	50	50	27	12.4	7	22	35	14	10	1.2	1
16125RS14	●	125	123	50	50	27	12.4	7	22	35	14	14	1.2	1
16125RS22	●	125	123	50	50	27	12.4	7	22	35	14	22	1.3	1
16160RS12	●	160	158	80	63	40	16.4	9	29	52	29	12	2.6	1
16160RS20	●	160	158	80	63	40	16.4	9	29	52	29	20	2.6	1
16160RS28	●	160	158	80	63	40	16.4	9	29	52	29	28	2.6	1
ANXA 1608R06	●	80	78	50	50	25.4	9.5	6	25	35	14	6	0.5	1
1608R10	●	80	78	50	50	25.4	9.5	6	25	35	14	10	0.5	1
1608R14	●	80	78	50	50	25.4	9.5	6	25	35	14	14	0.5	1
16100R08	●	100	98	50	50	25.4	9.5	6	25	35	14	8	0.8	1
16100R12	●	100	98	50	50	25.4	9.5	6	25	35	14	12	0.9	1
16100R18	●	100	98	50	50	25.4	9.5	6	25	35	14	18	0.9	1
16125R10	●	125	123	50	50	25.4	9.5	6	25	35	14	10	1.2	1
16125R14	●	125	123	50	50	25.4	9.5	6	25	35	14	14	1.2	1
16125R22	●	125	123	50	50	25.4	9.5	6	25	35	14	22	1.3	1
16160R12	●	160	158	80	63	38.1	15.9	10	35.5	55	30	12	2.3	1
16160R20	●	160	158	80	63	38.1	15.9	10	35.5	55	30	20	2.4	1
16160R28	●	160	158	80	63	38.1	15.9	10	35.5	55	30	28	2.6	1

Blades are sold separately.
 If using blades with corner radius (ANB1604R/ANB1608R), DC = DCX.
 Weight indicated includes the weight with blades and other spare parts (excluding the centre bolt).
 All aluminum alloy cutter bodies from (DCX) ø80 to ø125 have similar bore diameter (DCB) (metric ø27/inch ø25.4).
 Note: The values in red have been changed from Rev. 3 and the 2021-2022 General Catalogue.

Identification Code

ANX A 16 100 R S 18

Series Code Aluminum Alloy Body Blade Size Max. Dia. Feed Direction Metric Bore Number of Teeth

■ Precautions when Using Wiper Blades

· W type Setting

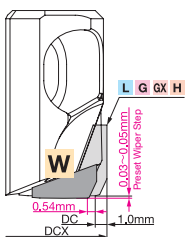

⚠ Precautions

In order to maintain cutter balance when using the W type wiper blade, use a cutter with an even-number of cutting teeth and place another W type wiper blade at the opposite teeth position.

· WS type Setting

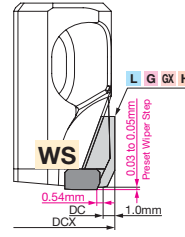

⚠ Precautions

(For more details, refer to the instruction manual included with the product)

In order to maintain cutter balance when using the WS type (SCV10 wiper blade), use a cutter with an even-number of cutting teeth and place another WS type wiper blade (or dummy blade ANBD) at opposite teeth positions.

*The dummy blade is dedicated for use with WS type.



Blade

Dimensions (mm)

Grade Classification	SUMIDIA		SUMICRYSTAL V	Cutting Edge Length	Corner Radius RE	Wiper Edge Shape	Applications	Fig
	High-speed/Light Cutting	General-purpose	Roughing					
Process	N	K	N					
	N	K						
	N	K						
Cat. No.	DA1000	DA90	SCV10					
ANB 1600R-L	●		—	6.0	—	Linear	Low Cutting Force	1
ANB 1600R-G	●		—	6.0	—	Arc-Shaped	General-purpose	1
ANB 1600R-GB		●	—	6.0	—	Arc-Shaped	Composite Milling	1
ANB 1600R-H	●	—	—	6.0	—	Arc-Shaped	Strong Edge	1
ANB 1600R-GX	●	—	—	9.0	—	Arc-Shaped	Long Edge	2
ANB 1604R	●	—	—	6.0	0.4	Linear	Corner Radius	3
ANB 1608R	●	—	—	6.0	0.8	Linear	Corner Radius	3
ANB 1600R-W	●	—	—	—	—	Arc-Shaped	Wiper	4
ANB 1600R-WS	—	—	●	—	—	Arc-Shaped	Wiper	5
ANBD	—	—	● ^{*2}	—	—	—	Dummy Blade	6

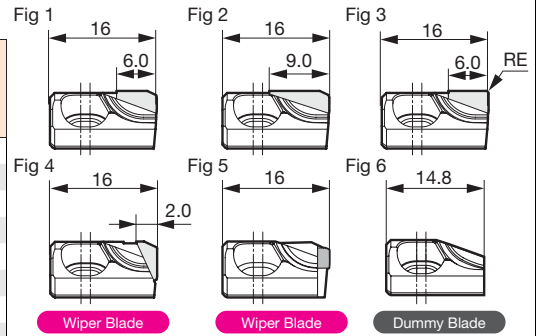

*1 Cast iron/aluminum alloy *2 Dummy blade for use with WS type (cemented carbide), refer to M36 "Precautions when Using Wiper Blades" (Mounting Precautions).

Recommended Cutting Conditions

Si content of 12.6% or less

ISO	Work Material	Hardness	Cutting Speed vc (m/min) Min. - Optimum - Max.	Feed Rate fz (mm/t) Min. - Optimum - Max.	Blade Grade
N	Aluminum Alloy	—	2,000 - 2,500 - 3,000	0.05 - 0.13 - 0.20	DA1000 SCV10

Si content of over 12.6%

ISO	Work Material	Hardness	Cutting Speed vc (m/min) Min. - Optimum - Max.	Feed Rate fz (mm/t) Min. - Optimum - Max.	Blade Grade
N	Aluminum Alloy	—	400 - 600 - 800	0.05 - 0.13 - 0.20	DA1000 DA90 SCV10

Combined Milling of Cast Iron/Aluminum Alloy

ISO	Work Material	Hardness	Cutting Speed vc (m/min) Min. - Optimum - Max.	Feed Rate fz (mm/t) Min. - Optimum - Max.	Blade Grade
K	Cast Iron/	—	300 - 400 - 500	0.05 - 0.13 - 0.20	DA90
N	Aluminum Alloy	—			

Note The cutting conditions above are a guide. Actual conditions will need to be adjusted according to machine rigidity, work clamp rigidity, depth of cut and other factors. For combined milling of cast iron/aluminum alloy, we recommend DA90. When using wiper blade WS type, see the table below.

Parts

Applicable Cutter	Cap Screw	Wrench	Adjustment Screw	Adjustment Wrench	Centre Bolt
	ANXA 16080R(S)○○ ANXA 16100R(S)○○ ANXA 16125R(S)○○ ANXA 16160R(S)○○	BXA0310IP	2.0 TRXW10IP	HFJ	ANT

The adjustment wrench (ANT) can also be used for height adjustment of the High-speed Cutter RF type and High-efficiency Cutter HF type.

Maximum Allowable Spindle Speed

Cat. No.	n max(min ⁻¹)
ANXA 16080RS06	20,000
16080RS10	20,000
16080RS14	20,000
16100RS08	18,000
16100RS12	18,000
16100RS18	18,000
16125RS10	16,000
16125RS14	16,000
16125RS22	16,000
16160RS12	14,000
16160RS20	14,000
16160RS28	14,000
ANXA 16080R06	20,000
16080R10	20,000
16080R14	20,000
16100R08	18,000
16100R12	18,000
16100R18	18,000
16125R10	16,000
16125R14	16,000
16125R22	16,000
16160R12	14,000
16160R20	14,000
16160R28	14,000

*The maximum allowable spindle speeds are set to prevent the inserts from dislodging by centrifugal force.

Wiper Blade WS type Recommended Feed Rate

WS Cutting Edge Feed Rate per Tooth ^{*1} fz _{ws} (mm/t _{ws})	D ≤ 0.5	0.5 < D ≤ 1.7	1.7 < D
Burr-free Finish	◎ Excellent		Impossible
Mirror Finishing	◎ Excellent	○ Good	
Target Surface Roughness Ra (μm)	0.015 to 0.05		

*1 Feed Rate per WS Cutting Edge Tooth fz_{ws} Feed Rate per Tooth fz

$$fz_{ws} \text{ (mm/t}_{ws}\text{)} = \frac{fz \times (\text{Total No. of Teeth})^2}{(\text{WS type No. of Teeth})^3}$$

$$fz \text{ (mm/t)} = \frac{\text{Feed Rate (vf) (mm/min)}}{\text{Spindle Speed n (min}^{-1}\text{)} \times (\text{Total No. of Teeth})}$$

*2 Total number of teeth includes dummy blade and wiper blade (WS type).

*3 WS type number of teeth does not include dummy blade.



ANXS 16000R(S) type

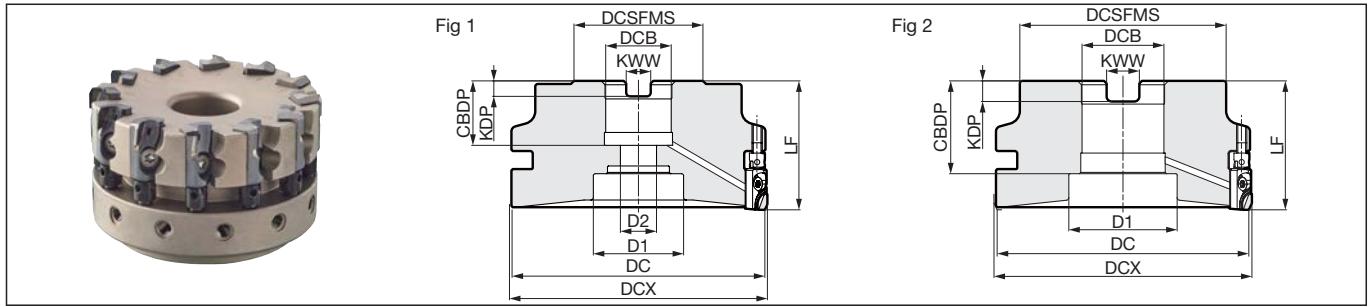
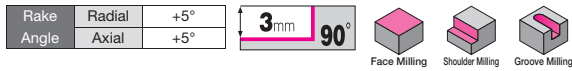

Body (Steel)

Dimensions (mm)

Cat. No.	Stock	Max. Dia. DCX	Dia. DC	Boss Dia. DCSFMS	Overall Length LF	Hole Dia. DCB	Keyway Width KWW	Keyway Depth KDP	Mounting Depth CDBP	Bolt D1	Bolt D2	Number of Teeth	Weight (kg)	Fig
ANXS 16040RS04	●	40	38	38.5	40	16	8.4	5.6	18	14	9	4	0.3	1
16040RS06	●	40	38	38.5	40	16	8.4	5.6	18	14	9	6	0.3	1
16050RS04	●	50	48	48.5	40	22	10.4	6.3	20	18	11	4	0.4	1
16050RS06	●	50	48	48.5	40	22	10.4	6.3	20	18	11	6	0.4	1
16050RS09	●	50	48	48.5	40	22	10.4	6.3	20	18	11	9	0.4	1
16063RS06	●	63	61	50	40	22	10.4	6.3	20	18	11	6	0.7	1
16063RS08	●	63	61	50	40	22	10.4	6.3	20	18	11	8	0.7	1
16063RS12	●	63	61	50	40	22	10.4	6.3	20	18	11	12	0.7	1
16080RS06	●	80	78	50	50	27	12.4	7	22	35	14	6	1.2	1
16080RS10	●	80	78	50	50	27	12.4	7	22	35	14	10	1.2	1
16080RS14	●	80	78	50	50	27	12.4	7	22	35	14	14	1.2	1
16100RS08	●	100	98	80	50	32	14.4	8	32	46	—	8	1.9	2
16100RS12	●	100	98	80	50	32	14.4	8	32	46	—	12	2.0	2
16100RS18	●	100	98	80	50	32	14.4	8	32	46	—	18	2.0	2
16125RS10	●	125	123	80	63	40	16.4	9	29	52	29	10	3.8	1
16125RS14	●	125	123	80	63	40	16.4	9	29	52	29	14	3.9	1
16125RS22	●	125	123	80	63	40	16.4	9	29	52	29	22	3.9	1
ANXS 16063R06	●	63	61	50	50	25.4	9.5	6	25	20	14	6	0.9	1
16063R08	●	63	61	50	50	25.4	9.5	6	25	20	14	8	0.9	1
16063R12	●	63	61	50	50	25.4	9.5	6	25	20	14	12	0.9	1
16080R06	●	80	78	50	50	25.4	9.5	6	25	35	14	6	1.2	1
16080R10	●	80	78	50	50	25.4	9.5	6	25	35	14	10	1.2	1
16080R14	●	80	78	50	50	25.4	9.5	6	25	35	14	14	1.2	1
16100R08	●	100	98	80	50	31.75	12.7	8	36	42	—	8	1.9	2
16100R12	●	100	98	80	50	31.75	12.7	8	36	42	—	12	2.0	2
16100R18	●	100	98	80	50	31.75	12.7	8	36	42	—	18	2.0	2
16125R10	●	125	123	80	63	38.1	15.9	10	35.5	52	29	10	3.9	1
16125R14	●	125	123	80	63	38.1	15.9	10	35.5	52	29	14	3.9	1
16125R22	●	125	123	80	63	38.1	15.9	10	35.5	52	29	22	3.9	1

Blades are sold separately.

If using blades with corner radius (ANB1604R/ANB1608R), DC = DCX.

Weight indicated includes the weight with blades and other spare parts (excluding the centre bolt).

Note: The values in red have been changed from Rev. 3 and the 2021-2022 General Catalogue.

Identification Code

ANX S 16 100 R S 18

Series Code Steel Body Blade Max. Dia. Feed Metric Number Size of Teeth

SUMIDIA

M

SUMIDIA BINDERLESS

SUMICRYSTAL

C

D

S

T

V

W



Blade

Dimensions (mm)

Grade Classification	SUMIDIA		SUMICRYSTAL V	Cutting Edge Length	Corner Radius RE	Wiper Edge Shape	Applications	Fig
	High-speed/Light Cutting	General-purpose	Roughing					
Process	N	K	N					
	N	K						
	N	K						
Cat. No.	DA1000	DA90	SCV10					
ANB 1600R-L	●		—	6.0	—	Linear	Low Cutting Force	1
ANB 1600R-G	●		—	6.0	—	Arc-Shaped	General-purpose	1
ANB 1600R-GB		●	—	6.0	—	Arc-Shaped	Composite Milling*	1
ANB 1600R-H	●	—	—	6.0	—	Arc-Shaped	Strong Edge	1
ANB 1600R-GX	●	—	—	9.0	—	Arc-Shaped	Long Edge	2
ANB 1604R	●	—	—	6.0	0.4	Linear	Corner Radius	3
ANB 1608R	●	—	—	6.0	0.8	Linear	Corner Radius	3
ANB 1600R-W	●	—	—	—	—	Arc-Shaped	Wiper	4
ANB 1600R-WS	—	—	●	—	—	Arc-Shaped	Wiper	5
ANBD	—	—	●	—	—	—	Dummy Blade	6

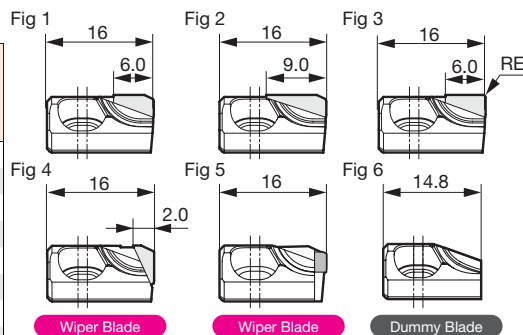

*1 Cast iron/aluminum alloy *2 Dummy blade for use with WS type (cemented carbide), refer to M36 "Precautions when Using Wiper Blades" (Mounting Precautions).

Recommended Cutting Conditions

Si content of 12.6% or less

ISO	Work Material	Hardness	Cutting Speed vc (m/min) Min. - Optimum - Max.	Feed Rate fz (mm/t) Min. - Optimum - Max.	Blade Grade
N	Aluminum Alloy	—	2,000 - 2,500 - 3,000	0.05 - 0.13 - 0.20	DA1000 DA90 SCV10

Si content of over 12.6%

ISO	Work Material	Hardness	Cutting Speed vc (m/min) Min. - Optimum - Max.	Feed Rate fz (mm/t) Min. - Optimum - Max.	Blade Grade
N	Aluminum Alloy	—	400 - 600 - 800	0.05 - 0.13 - 0.20	DA1000 DA90 SCV10

Combined Milling of Cast Iron/Aluminum Alloy

ISO	Work Material	Hardness	Cutting Speed vc (m/min) Min. - Optimum - Max.	Feed Rate fz (mm/t) Min. - Optimum - Max.	Blade Grade
K N	Cast Iron/ Aluminum Alloy	—	300 - 400 - 500	0.05 - 0.13 - 0.20	DA90

Note The cutting conditions above are a guide. Actual conditions will need to be adjusted according to machine rigidity, work clamp rigidity, depth of cut and other factors. For combined milling of cast iron/aluminum alloy, we recommend DA90. When using wiper blade WS type, refer to page M37.

Parts

Applicable Cutter	Cap Screw	Wrench	Adjustment Screw	Adjustment Wrench	Centre Bolt	
ANXS 1604RS00					BXH0825-D13	15
ANXS 1605RS00					BXH1030-D16	25
ANXS 16063RS00	BXA0310IP	2.0	TRXW10IP	HFJ	ANT	
ANXS 16080RS00					BXH1235-D33	50
ANXS 16100RS00					BXH1635-D40	100
ANXS 16125RS00					BXH2036-D50	200
ANXS 16063R00					BXH1235-D18	40
ANXS 16080R00	BXA0310IP	2.0	TRXW10IP	HFJ	ANT	
ANXS 16100R00					BXH1235-D33	50
ANXS 16125R00					BXH1635-D40	100
					BXH2036-D50	200

The adjustment wrench (ANT) can also be used for height adjustment of the High-speed Cutter RF type and High-efficiency Cutter HF type.

Maximum Allowable Spindle Speed

Cat. No.	n max(min ⁻¹)
ANXS 1604RS04	25,000
1604RS06	25,000
1605RS04	25,000
1605RS06	25,000
1605RS09	25,000
16063RS06	22,000
16063RS08	22,000
16063RS12	22,000
16080RS06	20,000
16080RS10	20,000
16080RS14	20,000
16100RS08	18,000
16100RS12	18,000
16100RS18	18,000
16125RS10	16,000
16125RS14	16,000
16125RS22	16,000
ANXS 16063R06	22,000
16063R08	22,000
16063R12	22,000
16080R06	20,000
16080R10	20,000
16080R14	20,000
16100R08	18,000
16100R12	18,000
16100R18	18,000
16125R10	16,000
16125R14	16,000
16125R22	16,000

*The maximum allowable spindle speeds are set to prevent the inserts from dislodging by centrifugal force.



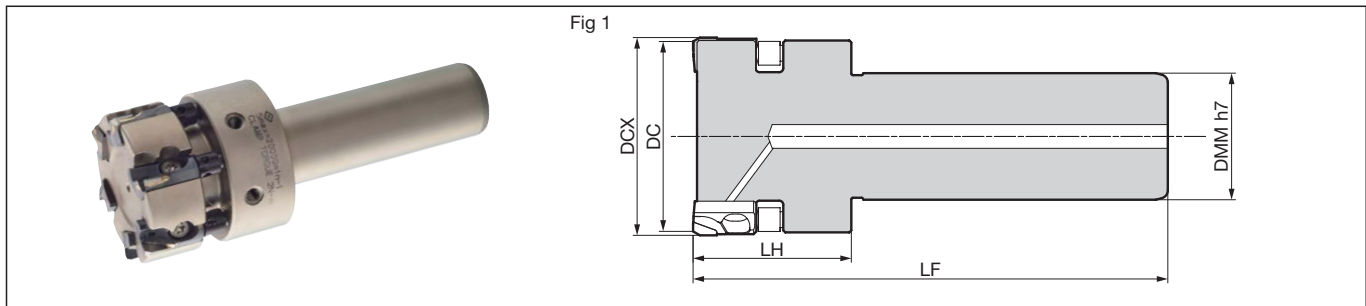
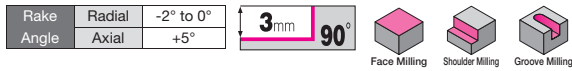

Body (Steel)

Dimensions (mm)

Cat. No.	Stock	Max. Dia. DCX	Dia. DC	Shank Dia. DMM	Head LH	Overall Length LF	Number of Teeth	Weight (kg)	Fig
ANXS 16025E02	●	25	23	20	35	95	2	0.2	1
16030E03	●	30	28	20	35	95	3	0.3	1
16030E04	●	30	28	20	35	95	4	0.3	1
16032E03	●	32	30	20	35	95	3	0.3	1
16032E04	●	32	30	20	35	95	4	0.3	1
16040E04	●	40	38	20	40	100	4	0.4	1
16040E06	●	40	38	20	40	100	6	0.5	1
16050E04	●	50	48	32	40	120	4	1.0	1
16050E06	●	50	48	32	40	120	6	1.0	1
16050E09	●	50	48	32	40	120	9	1.0	1

Blades are sold separately.

If using blades with corner radius (ANB1604R/ANB1608R), DC = DCX.

Weight indicated includes the weight with blades and other spare parts.

Identification Code

ANX **S** **16** **032** **E** **04**

Series Code Steel Body Blade Size Max. Dia. Shank type Number of Teeth

SUMIDIA

M

SUMIDIA
SUMIDIA
BINDERLESS

SUMICRYSTAL

C

D

S

T

V

W



Blade

Dimensions (mm)

Grade Classification		SUMIDIA		SUMICRYSTAL V											
Process	High-speed/Light Cutting	N	K	N	Cutting Edge Length	Corner Radius RE	Wiper Edge Shape	Applications	Fig						
	General-purpose	N	K												
	Roughing	N	K												
Cat. No.	DA1000	DA90	SCV10												
ANB 1600R-L	●		—	6.0	—	Linear	Low Cutting Force	1							
ANB 1600R-G	●		—	6.0	—	Arc-Shaped	General-purpose	1							
ANB 1600R-GB		●	—	6.0	—	Arc-Shaped	Composite Milling	1							
ANB 1600R-H	●	—	—	6.0	—	Arc-Shaped	Strong Edge	1							
ANB 1600R-GX	●	—	—	9.0	—	Arc-Shaped	Long Edge	2							
ANB 1604R	●	—	—	6.0	0.4	Linear	Corner Radius	3							
ANB 1608R	●	—	—	6.0	0.8	Linear	Corner Radius	3							
ANB 1600R-W	●	—	—	—	—	Arc-Shaped	Wiper	4							
ANB 1600R-WS	—	—	●	—	—	Arc-Shaped	Wiper	5							
ANBD	—	—	●	—	—	—	Dummy Blade	6							

*1 Cast iron/aluminum alloy *2 Dummy blade for use with WS type (cemented carbide), refer to M36 "Precautions when Using Wiper Blades" (Mounting Precautions).

Recommended Cutting Conditions

Si content of 12.6% or less

ISO	Work Material	Hardness	Cutting Speed vc (m/min) Min. - Optimum - Max.	Feed Rate fz (mm/t) Min. - Optimum - Max.	Blade Grade
N	Aluminum Alloy	—	2,000 - 2,500 - 3,000	0.05 - 0.13 - 0.20	DA1000 SCV10

Si content of over 12.6%

ISO	Work Material	Hardness	Cutting Speed vc (m/min) Min. - Optimum - Max.	Feed Rate fz (mm/t) Min. - Optimum - Max.	Blade Grade
N	Aluminum Alloy	—	400 - 600 - 800	0.05 - 0.13 - 0.20	DA1000 DA90 SCV10

Combined Milling of Cast Iron/Aluminum Alloy

ISO	Work Material	Hardness	Cutting Speed vc (m/min) Min. - Optimum - Max.	Feed Rate fz (mm/t) Min. - Optimum - Max.	Blade Grade
K N	Cast Iron/ Aluminum Alloy	—	300 - 400 - 500	0.05 - 0.13 - 0.20	DA90

Note · The above are the recommended conditions for ANX series overall. Use within the maximum allowable spindle speed.
· The cutting conditions above are a guide. Actual conditions will need to be adjusted according to machine rigidity, work clamp rigidity, depth of cut and other factors.
For combined milling of cast iron/aluminum alloy, we recommend DA90.
· When using wiper blade WS type, refer to page M37.

Parts

Cap Screw	Wrench	Adjustment Screw	Adjustment Wrench
BXA0310IP	2.0 TRXW10IP	HFJ	ANT

The adjustment wrench (ANT) can also be used for height adjustment of the High-speed Cutter RF type and High-efficiency Cutter HF type.

Maximum Allowable Spindle Speed

Cat. No.	n max(min ⁻¹)
ANXS 16025E02	10,000
16030E03	10,000
16030E04	10,000
16032E03	10,000
16032E04	10,000
16040E04	10,000
16040E06	10,000
16050E04	10,000
16050E06	10,000
16050E09	10,000

*The maximum allowable spindle speeds are set to prevent the inserts from dislodging by centrifugal force.

ANXS 16000M type

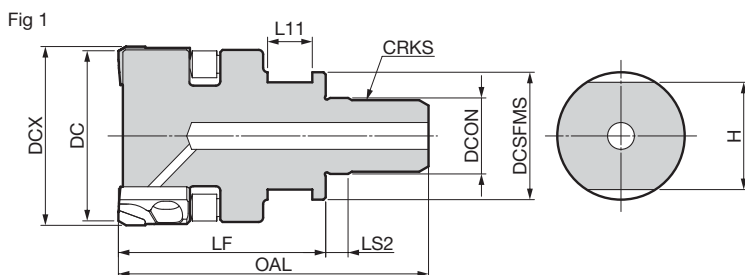
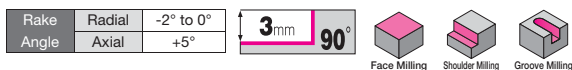

Body (Steel)

Dimensions (mm)

Cat. No.	Stock	Max. Dia. DCX	Dia. DC	Boss DCSFMS	Mounting Dia. DCON	Screw CRKS	Overall Length OAL	Effective Length LF	Length LS2	Chamfer L11	Width H	Number of Teeth	Weight (kg)	Fig
ANXS 16025M12Z02	●	25	23	23.0	12.5	M12	61	40	5	10	19	2	0.1	1
16030M16Z03	●	30	28	28.5	17.0	M16	70	47	5	10	24	3	0.2	1
16030M16Z04	●	30	28	28.5	17.0	M16	70	47	5	10	24	4	0.2	1
16032M16Z03	●	32	30	28.5	17.0	M16	70	47	5	10	24	3	0.3	1
16032M16Z04	●	32	30	28.5	17.0	M16	70	47	5	10	24	4	0.3	1
16040M16Z04	●	40	38	28.5	17.0	M16	70	47	5	10	24	4	0.4	1
16040M16Z06	●	40	38	28.5	17.0	M16	70	47	5	10	24	6	0.4	1

Blades are sold separately.

If using blades with corner radius (ANB1604R/ANB1608R), DC = DCX.

Weight indicated includes the weight with blades and other spare parts.

Arbors **H255**

Blade Expansion

Dimensions (mm)

Grade Classification		SUMIDIA		SUMICRYSTAL V									
Process	High-speed/Light Cutting	N	K	N	Cat. No.	DA1000	DA90	SCV10	Cutting Edge Length	Corner Radius RE	Wiper Edge Shape	Applications	Fig
	General-purpose	N	K			DA1000	DA90	SCV10					
	Roughing	N	K			DA1000	DA90	SCV10					
					ANB 1600R-L	●		—	6.0	—	Linear	Low Cutting Force	1
					ANB 1600R-G	●		—	6.0	—	Arc-Shaped	General-purpose	1
					ANB 1600R-GB		●	—	6.0	—	Arc-Shaped	Composite Milling	1
					ANB 1600R-H	●	—	—	6.0	—	Arc-Shaped	Strong Edge	1
					ANB 1600R-GX	●	—	—	9.0	—	Arc-Shaped	Long Edge	2
					ANB 1604R	●	—	—	6.0	0.4	Linear	Corner Radius	3
					ANB 1608R	●	—	—	6.0	0.8	Linear	Corner Radius	3
					ANB 1600R-W	●	—	—	—	—	Arc-Shaped	Wiper	4
					ANB 1600R-WS	—	—	●	—	—	Arc-Shaped	Wiper	5
					ANBD	—	—	● ^{*2}	—	—	—	Dummy Blade	6

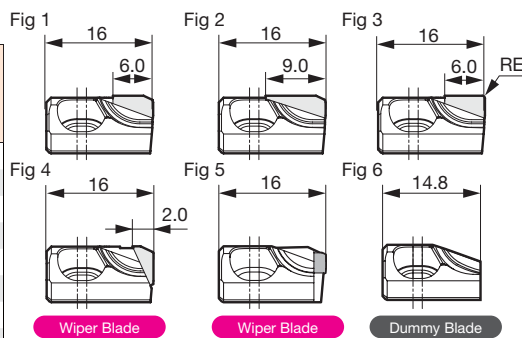

*1 Cast iron/aluminum alloy *2 Dummy blade for use with WS type (cemented carbide), refer to M36
 "Precautions when Using Wiper Blades" (Mounting Precautions).

Recommended Cutting Conditions **M41**

Identification Code

ANX S 16 032 M16 Z03

Series Code Steel Body Blade Size Max. Dia. Screw Size Number of Teeth

Parts

Cap Screw	Adjustment Screw	Wrench	Adjustment Wrench
BXA0310IP	2.0	HFJ	TRXW10IP ANT

The adjustment wrench (ANT) can also be used for height adjustment of the High-speed Cutter RF type and High-efficiency Cutter HF type.

Maximum Allowable Spindle Speed

Cat. No.	n max(min ⁻¹)
ANXS 16025M12Z02	10,000
16030M16Z03	10,000
16030M16Z04	10,000
16032M16Z03	10,000
16032M16Z04	10,000
16040M16Z04	10,000
16040M16Z06	10,000

*The maximum allowable spindle speeds are set to prevent the inserts from dislodging by centrifugal force.

MEMO

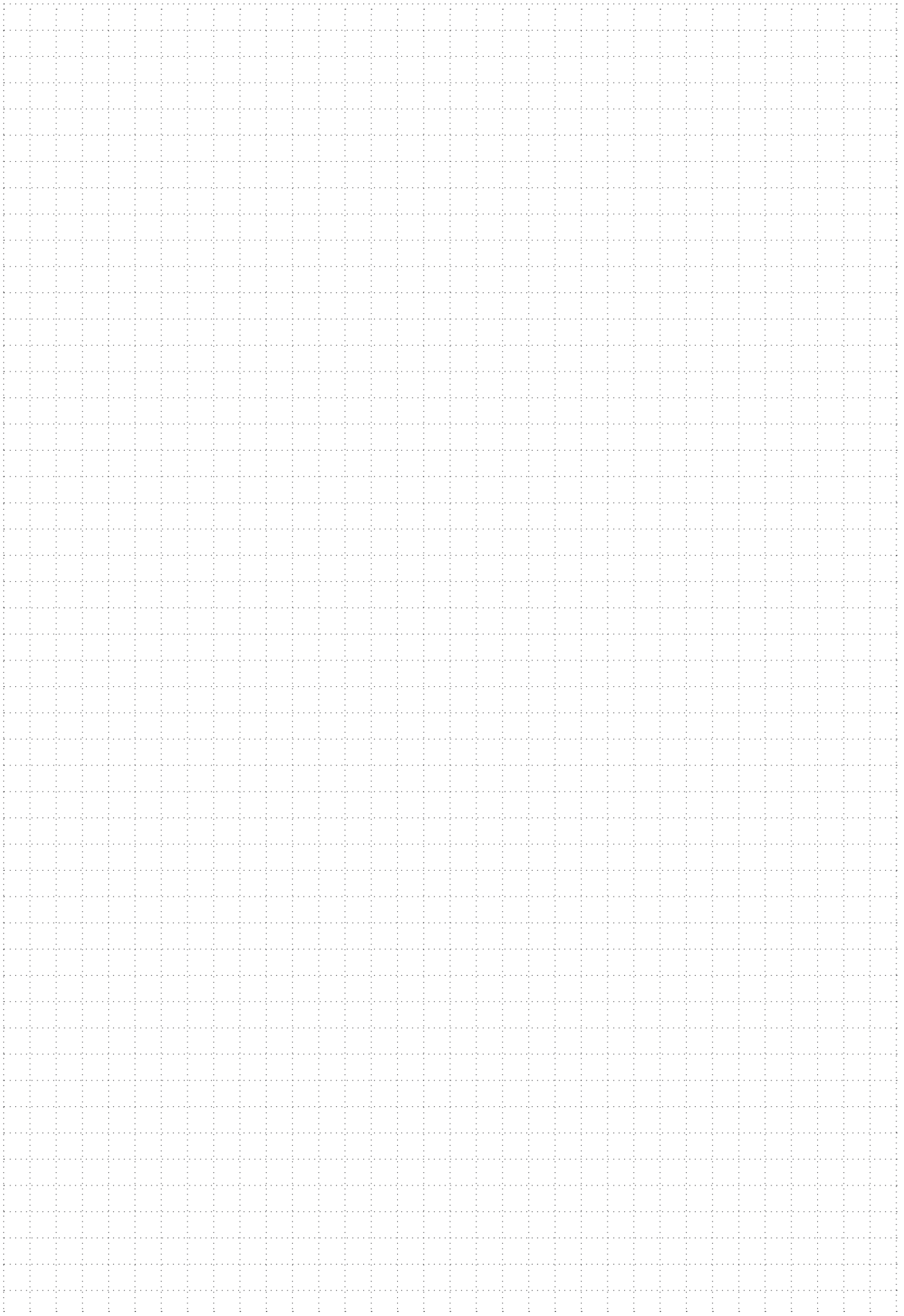



SUMIDIA

M

SUMIDIA
SUMIDIA
BINDERLESS

SUMICRYSTAL

C

D

S

T

V

W



Features

The HF type high-efficiency aluminum alloy cutter employs a unique blade design to achieve machining without burrs.

HFFH type with coolant holes is now available as a BBT30 (BIG-PLUS™) arbor integrated version.

Work Material

- Aluminum and aluminum alloys
 - Other non-ferrous metals
- (Not suited for cast iron or steel.)



High-feed, High-efficiency Milling with Multi-blade Design

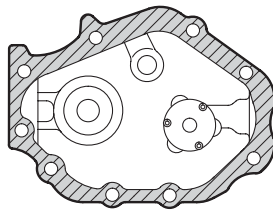

Workpiece: Aluminum Case (Frame Milling)
Tool: **HFF12080R-25.4** (ø80 10-tooth),
Conventional Tool (ø80 6-tooth)

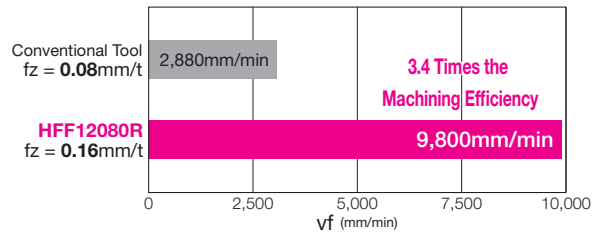

Maximum Allowable Spindle Speed and Feed Rate

Cutter Dia. (mm)	n _{max} (min ⁻¹)	vc (m/min)	fz (mm/t)	Max. No. of Teeth (pcs.)	vf (mm/min)
ø80	11,000	2,763	up to 0.2	10	up to 22,000
ø100	9,500	2,983	up to 0.2	12	up to 22,800
ø125	7,500	2,944	up to 0.2	15	up to 22,500

* The maximum allowable spindle speeds are set to prevent the inserts from dislodging by centrifugal force.

Reduces burrs by using a double-chamfered blade type

Drastically reduces burrs by preventing plastic deformation that causes burrs.

Work Material: **A6061** Rolled Steel
Cutting Conditions: vc = **3,142**m/min,
fz = **0.10**mm/t,
ap = **0.5**mm, Dry

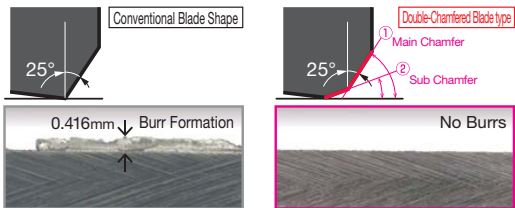

Wedge clamp with anti-fly-out mechanism ensures safety and operability

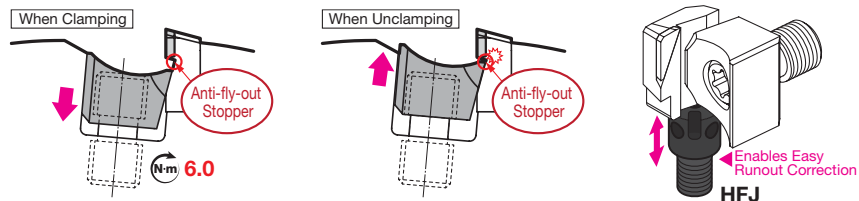

Ensure that the maximum allowable spindle speed (n_{max}) specified for each cutter diameter is not exceeded. (See the table at upper right)

Reduces running costs by drastically increasing blade regrinding allowance (to 1.8mm)

Assuming 0.2mm of regrinding each time, an edge can be used up to 10 times.

(Given conditions of normal wear with ap = 1.4mm or less)

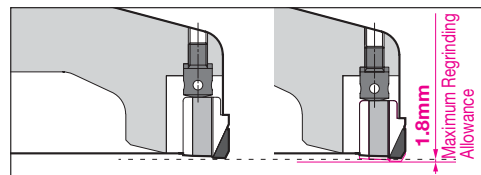
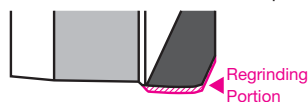

The regrinding allowance has been drastically increased compared to conventional screw-lock types.

Internal coolant improves chip evacuation performance (HFFH type, HFFH-BBT30 type)

The internal coolant effectively prevents chips from becoming clogged or biting into the work material and achieves longer tool life. (Use an internal coolant compatible arbor)

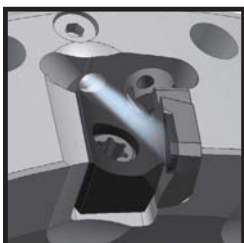

*1: BIG-PLUS™ is a registered trademark of BIG DAISHOWA Co., Ltd.
*2: Can also be used with BT30 spindle machines.

HF series

Product Range

Type	Cat. No.	Dia. (mm)		
		ø80	ø100	ø125
Shell	HFM 12000RS	6*	8	10*
	HFM 12000R	6	8*	10*
	HFF 12000RS	10*	12	15*
	HFF 12000R	10	12*	15*
	HFFH 12000RS	10*	12	15*
	HFFH 12000R	10	12*	15*
	HFFH 12000R-BBT30	10	12	15

Number in ● shows the number of teeth Inch Bore *mark: Different diameter shanks in stock

Blade Selection Guide

Work Material	N				
Applications	Reduction of Back Force	General-purpose	Roughing	Emphasis on Fracture Resistance	Finishing
Features	Low Cutting Force	Standard	Long Edge	High Strength	Wiper
Type	L type	G type	GX type	H type	W type
Cutting Edge Shape					
Edge Length (mm)	6.0mm	6.0mm	9.0mm	6.0mm	2.0mm

Blade Selection Reference

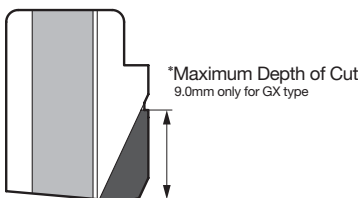
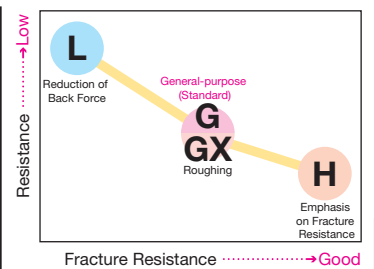

Wiper Blade Step Amount

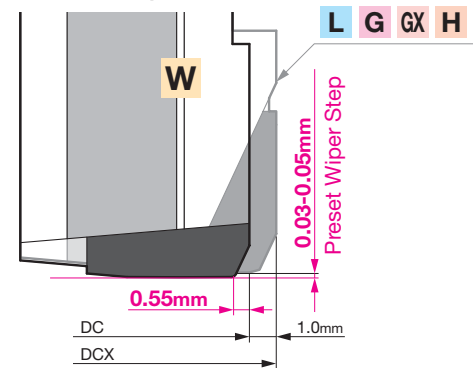

Structure of HF type

The axial set screw and balance adjustment screw hole have an embedded special part that prevents the insertion of screwdrivers or hex wrenches.

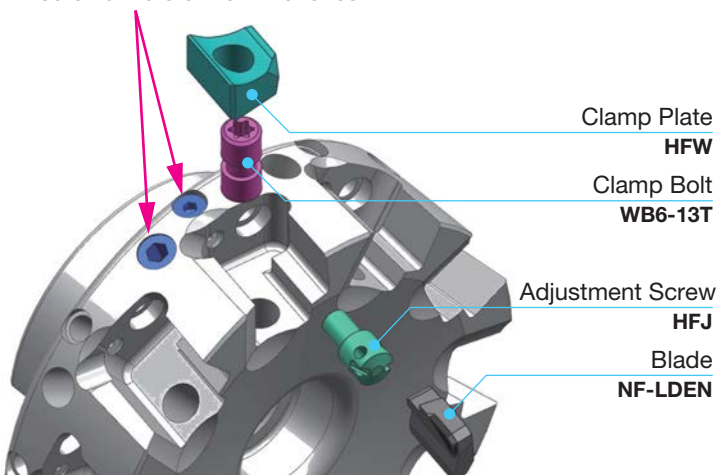

Blade Mounting Direction

Loosen the screw by one turn before removing the blade.

Note that if the insert is forcibly removed in the wrong direction, the part may break.

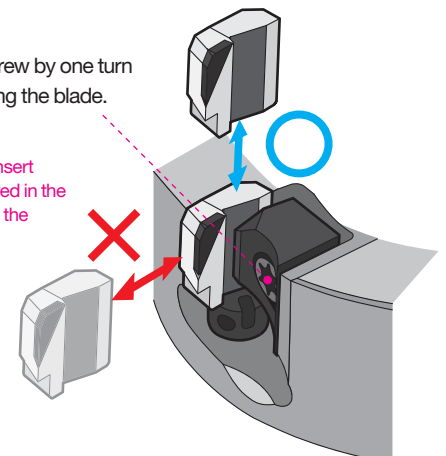

SUMIDIA
M
SUMIDIA
BINDERLESS
SUMICRYSTAL
C
D
S
T
V
W

HFM 12000RS/R type

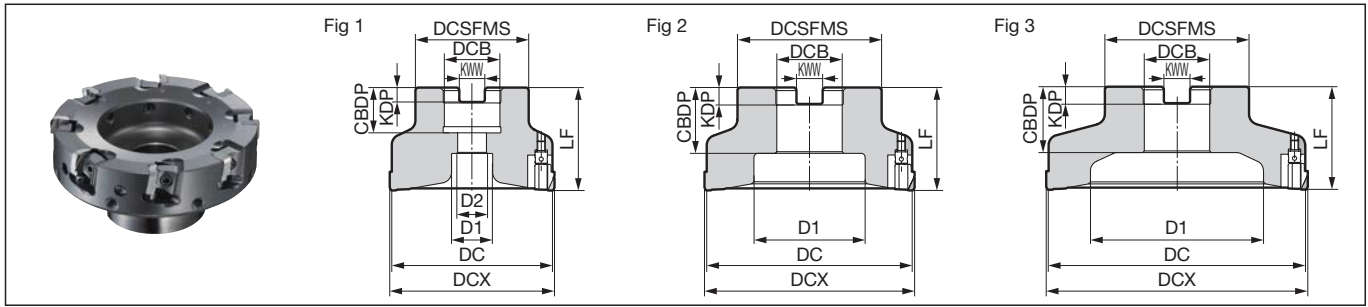
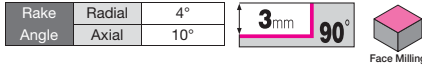

Body (Fine Pitch: 2-teeth/Inch)

Dimensions (mm)

Cat. No.	Stock	Dia. DC	Max. Dia. DCX	Boss DCSFMS	Overall Length LF	Hole Dia. DCB	Keyway Width KWW	Keyway Depth KDP	Mounting Depth CDBP	Bolt D1	Bolt D2	Number of Teeth	Weight (kg)	Fig
HFM 12080RS-22	●	80	82	50	40	22	10.4	6.3	20	18	11	6	1.0	1
12080RS-27	●	80	82	55	50	27	12.4	7	22	20	14	6	1.2	1
12100RS-32	●	100	102	70	50	32	14.4	8	32	54	—	8	1.7	2
12125RS-32	●	125	127	70	50	32	14.4	8	32	84	—	10	2.2	3
12125RS-40	●	125	127	90	63	40	16.4	9	35	84	—	10	2.8	3
HFM 12080R-25.4	●	80	82	50	50	25.4	9.5	6	30	35	—	6	1.0	2
12100R-25.4	●	100	102	50	50	25.4	9.5	6	30	54	—	8	1.5	2
12100R-31.75	●	100	102	70	50	31.75	12.7	8	32	54	—	8	1.7	2
12125R-25.4	●	125	127	50	50	25.4	9.5	6	30	84	—	10	2.0	3
12125R-31.75	●	125	127	70	50	31.75	12.7	8	32	84	—	10	2.2	3
12125R-38.1	●	125	127	80	63	38.1	15.9	10	36	84	—	10	2.5	3

Blades are sold separately.

Blade

Dimensions (mm)

Grade Classification		SUMIDIA
Process	High-speed/Light Cutting	N
	General-purpose	N
	Roughing	N

Cat. No.	DA1000	Cutting Edge Length	Wiper Edge Shape	Applications	Fig
NF-LDEN 12T3ZDFR-L	●	6.0	Linear	Low Cutting Force	1
12T3ZDFR-G	●	6.0	Arc-Shaped	General-purpose	1
12T3ZDTR-H	●	6.0	Arc-Shaped	Strong Edge	1
12T3ZDFR-GX	●	9.0	Arc-Shaped	Long Edge	2
12T3ZDFR-W	●	2.0	Arc-Shaped	Wiper	3

Parts

(Sold Separately)

Clamp Plate	Bolt	Adjustment Screw	Wrench	Wrench	Assembly Wrench
HFV	WB6-13T	6.0	HFJ	TTX20	RFT

Identification Code

HF M 12 080 R S - 22

Series Code Fine Pitch Blade Size Dia. Feed Direction Metric Bore Hole Dia.

Recommended Cutting Conditions

Si content of 12.6% or less

ISO	Work Material	Cutting Speed vc (m/min) Min. - Optimum - Max.	Feed Rate fz (mm/t) Min. - Optimum - Max.	Blade Grade
N	Aluminum Alloy	2,000-2,500-3,000	0.05-0.13-0.20	DA1000

Note · The cutting conditions are a guide. Actual conditions will need to be adjusted according to machine rigidity, work clamp rigidity, depth of cut and other factors.
· The above are the recommended conditions for HF type overall. Use within the maximum allowable spindle speed.

Si content of over 12.6%

ISO	Work Material	Cutting Speed vc (m/min) Min. - Optimum - Max.	Feed Rate fz (mm/t) Min. - Optimum - Max.	Blade Grade
N	Aluminum Alloy	400-600-800	0.05-0.13-0.20	DA1000

Note The cutting conditions above are a guide. Actual conditions will need to be adjusted according to machine rigidity, work clamp rigidity, depth of cut and other factors.

HFF 12000RS/R type



Rake Angle	Radial	4°
	Axial	10°

3mm	90°
-----	-----

Face Milling

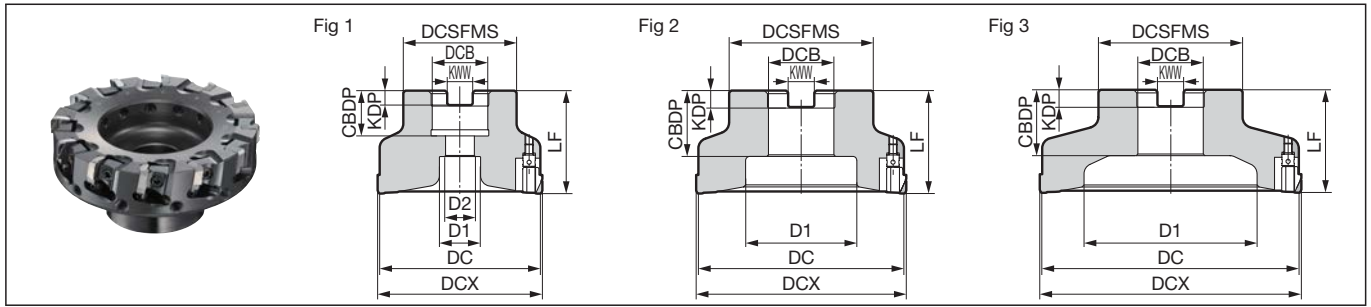

Body (Extra Fine Pitch: 3-Tooth/Inch)

Cat. No.		Stock	Dia. DC	Max. Dia. DCX	Boss DCSFMS	Overall Length LF	Hole Dia. DCB	Keyway Width KWW	Keyway Depth KDP	Mounting Depth CDBP	Bolt D1	Bolt D2	Number of Teeth	Weight (kg)	Fig
Metric	HFF 12080RS-22	●	80	82	50	40	22	10.4	6.3	20	18	11	10	1.0	1
	12080RS-27	●	80	82	55	50	27	12.4	7	22	20	14	10	1.2	1
	12100RS-32	●	100	102	70	50	32	14.4	8	32	54	—	12	1.7	2
	12125RS-32	●	125	127	70	50	32	14.4	8	32	84	—	15	2.2	3
	12125RS-40	●	125	127	90	63	40	16.4	9	35	84	—	15	2.8	3
Inch	HFF 12080R-25.4	●	80	82	50	50	25.4	9.5	6	30	35	—	10	1.0	2
	12100R-25.4	●	100	102	50	50	25.4	9.5	6	30	54	—	12	1.5	2
	12100R-31.75	●	100	102	70	50	31.75	12.7	8	32	54	—	12	1.7	2
	12125R-25.4	●	125	127	50	50	25.4	9.5	6	30	84	—	15	2.0	3
	12125R-31.75	●	125	127	70	50	31.75	12.7	8	32	84	—	15	2.2	3
	12125R-38.1	●	125	127	80	63	38.1	15.9	10	36	84	—	15	2.5	3

Blades are sold separately.

Blade

Grade Classification		SUMIDIA
Process	High-speed/Light Cutting	N
	General-purpose	N
	Roughing	N

Cat. No.	DA1000	Cutting Edge Length	Wiper Edge Shape	Applications	Fig
NF-LDEN 12T3ZDFR-L	●	6.0	Linear	Low Cutting Force	1
12T3ZDFR-G	●	6.0	Arc-Shaped	General-purpose	1
12T3ZDTR-H	●	6.0	Arc-Shaped	Strong Edge	1
12T3ZDFR-GX	●	9.0	Arc-Shaped	Long Edge	2
12T3ZDFR-W	●	2.0	Arc-Shaped	Wiper	3

Parts

Clamp Plate	Bolt	Adjustment Screw	Wrench	Wrench	Assembly Wrench
HFW	WB6-13T	6.0	HFJ	TTX20	RFT

(Sold Separately)

Identification Code

HF F 12 080 R S - 22

Series Code	Extra Fine Pitch	Blade Size	Dia.	Feed Direction	Metric Bore	Hole Dia.
-------------	------------------	------------	------	----------------	-------------	-----------

Recommended Cutting Conditions

Si content of 12.6% or less

ISO	Work Material	Cutting Speed vc (m/min) Min. - Optimum - Max.	Feed Rate fz (mm/t) Min. - Optimum - Max.	Blade Grade
N	Aluminum Alloy	2,000-2,500-3,000	0.05-0.13-0.20	DA1000

Note · The cutting conditions are a guide. Actual conditions will need to be adjusted according to machine rigidity, work clamp rigidity, depth of cut and other factors.
· The above are the recommended conditions for HF type overall. Use within the maximum allowable spindle speed.

Si content of over 12.6%

ISO	Work Material	Cutting Speed vc (m/min) Min. - Optimum - Max.	Feed Rate fz (mm/t) Min. - Optimum - Max.	Blade Grade
N	Aluminum Alloy	400-600-800	0.05-0.13-0.20	DA1000

Note The cutting conditions above are a guide. Actual conditions will need to be adjusted according to machine rigidity, work clamp rigidity, depth of cut and other factors.

HFFH 12000RS/R type

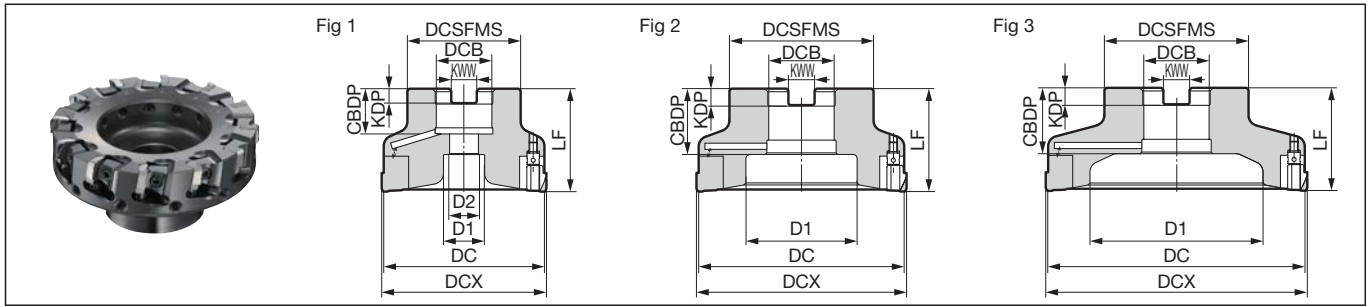
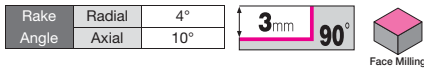

Body (Extra Fine Pitch: 3-Tooth/Inch) With Coolant Holes

Dimensions (mm)

Cat. No.	Stock	Dia. DC	Max. Dia. DCX	Boss DCSFMS	Overall Length LF	Hole Dia. DCB	Keyway Width KWW	Keyway Depth KDP	Mounting Depth CDBP	Bolt D1	Bolt D2	Number of Teeth	Weight (kg)	Fig
HFFH 12080RS-22	●	80	82	50	40	22	10.4	6.3	20	18	11	10	1.0	1
12080RS-27	●	80	82	55	50	27	12.4	7	22	20	14	10	1.2	1
12100RS-32	●	100	102	70	50	32	14.4	8	32	54	—	12	1.7	2
12125RS-32	●	125	127	70	50	32	14.4	8	32	84	—	15	2.2	3
12125RS-40	●	125	127	90	63	40	16.4	9	35	84	—	15	2.8	3
HFFH 12080R-25.4	●	80	82	50	50	25.4	9.5	6	30	35	—	10	1.0	2
12100R-25.4	●	100	102	50	50	25.4	9.5	6	30	54	—	12	1.5	2
12100R-31.75	●	100	102	70	50	31.75	12.7	8	32	54	—	12	1.7	2
12125R-25.4	●	125	127	50	50	25.4	9.5	6	30	84	—	15	2.0	3
12125R-31.75	●	125	127	70	50	31.75	12.7	8	32	84	—	15	2.2	3
12125R-38.1	●	125	127	80	63	38.1	15.9	10	36	84	—	15	2.5	3

Blades are sold separately.

Blade

Dimensions (mm)

Grade Classification	SUMIDIA
High-speed/Light Cutting	N
General-purpose	N
Roughing	N

Cat. No.	DA1000	Cutting Edge Length	Wiper Edge Shape	Applications	Fig
NF-LDEN 12T3ZDFR-L	●	6.0	Linear	Low Cutting Force	1
12T3ZDFR-G	●	6.0	Arc-Shaped	General-purpose	1
12T3ZDTR-H	●	6.0	Arc-Shaped	Strong Edge	1
12T3ZDFR-GX	●	9.0	Arc-Shaped	Long Edge	2
12T3ZDFR-W	●	2.0	Arc-Shaped	Wiper	3

Parts

(Sold Separately)

Clamp Plate	Bolt	Wrench	Adjustment Screw	Wrench	Assembly Wrench
HFV	WB6-13T	6.0	TTX20	HFJ	RFT

Identification Code

HF F H 12 080 R S - 22

Series Code Extra Fine Pitch With Oil Hole Blade Size Dia. Feed Direction Metric Bore Hole Dia.

Recommended Cutting Conditions

Si content of 12.6% or less

ISO	Work Material	Cutting Speed vc (m/min) Min. - Optimum - Max.	Feed Rate fz (mm/t) Min. - Optimum - Max.	Blade Grade
N	Aluminum Alloy	2,000-2,500-3,000	0.05-0.13-0.20	DA1000

Note · The above are the recommended conditions for HF type overall. Use within the maximum allowable spindle speed.
· The cutting conditions are a guide. Actual conditions will need to be adjusted according to machine rigidity, work clamp rigidity, depth of cut and other factors.

Si content of over 12.6%

ISO	Work Material	Cutting Speed vc (m/min) Min. - Optimum - Max.	Feed Rate fz (mm/t) Min. - Optimum - Max.	Blade Grade
N	Aluminum Alloy	400-600-800	0.05-0.13-0.20	DA1000

Note The cutting conditions above are a guide. Actual conditions will need to be adjusted according to machine rigidity, work clamp rigidity, depth of cut and other factors.

HFFH 12000R-BBT30 type



Rake Angle	Radial	4°
	Axial	10°

3mm	90°
-----	-----

Face Milling

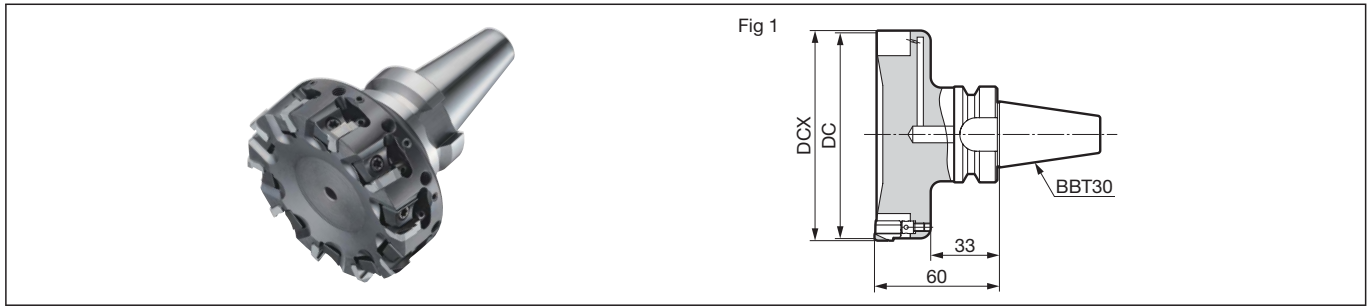

Body (Extra Fine Pitch: 3-Tooth/Inch) With Coolant Holes

Cat. No.		Stock	Dia. DC	Max. Dia. DCX	Number of Teeth	Weight (kg)	Fig
Inch	HFFH 12080R-BBT30	●	80	82	10	1.6	1
	12100R-BBT30	●	100	102	12	2.4	1
	12125R-BBT30	●	125	127	15	2.6	1

Blades are sold separately.

Note: The values in red have been changed from the 2021-2022 General Catalogue.

Blade

Grade Classification		SUMIDIA	Dimensions (mm)					
Process	High-speed/Light Cutting	N	Cat. No.	DA1000	Cutting Edge Length	Wiper Edge Shape	Applications	Fig
	General-purpose	N						
	Roughing	N						
	NF-LDEN 12T3ZDFR-L	●	6.0	Linear	Low Cutting Force	1		
	12T3ZDFR-G	●	6.0	Arc-Shaped	General-purpose	1		
	12T3ZDTR-H	●	6.0	Arc-Shaped	Strong Edge	1		
	12T3ZDFR-GX	●	9.0	Arc-Shaped	Long Edge	2		
	12T3ZDFR-W	●	2.0	Arc-Shaped	Wiper	3		

Fig 1		Fig 2		Fig 3	
12.7	6.0	12.7	9.0	12.7	2.0
3.962	9.525	3.962	9.525	3.962	8.525
15°		15°		15°	

Fig 3 Wiper Blade

Parts

(Sold Separately)

Clamp Plate	Bolt	Wrench	Adjustment Screw	Wrench	Assembly Wrench
HFW	WB6-13T	6.0	TTX20	HFJ	RFT

Identification Code

HF F H 12 080 R - BBT30

Series Code	Extra Fine Pitch	With Oil Hole	Blade Size	Dia.	Feed Direction	Supported Arbor Symbol
-------------	------------------	---------------	------------	------	----------------	------------------------

Recommended Cutting Conditions

Si content of 12.6% or less

ISO	Work Material	Cutting Speed vc (m/min) Min. - Optimum - Max.	Feed Rate fz (mm/t) Min. - Optimum - Max.	Blade Grade
N	Aluminum Alloy	2,000-2,500-3,000	0.05-0.13-0.20	DA1000

Note · The above are the recommended conditions for HF type overall. Use within the maximum allowable spindle speed.
· The cutting conditions are a guide. Actual conditions will need to be adjusted according to machine rigidity, work clamp rigidity, depth of cut and other factors.

Si content of over 12.6%

ISO	Work Material	Cutting Speed vc (m/min) Min. - Optimum - Max.	Feed Rate fz (mm/t) Min. - Optimum - Max.	Blade Grade
N	Aluminum Alloy	400-600-800	0.05-0.13-0.20	DA1000

Note The cutting conditions above are a guide. Actual conditions will need to be adjusted according to machine rigidity, work clamp rigidity, depth of cut and other factors.

* BIG-PLUS™ is a registered trademark of BIG DAISHOWA Co., Ltd.
* Can also be used with BT30 spindle machines.

SUMIDIA
M
SUMIDIA
BINDERLESS
SUMICRYSTAL
C
D
S
T
V
W

RF series

SUMIDIA



■ Features

The RF series cutter has a lightweight body designed for high-speed, high-performance roughing to finish milling of aluminum alloys and other non-ferrous metals.

■ Work Material

- Aluminum and aluminum alloys (Not suited for cast iron or steel.)
- Other Non-Ferrous Metals

M

- From Roughing to Finishing Processes: Roughing: Economical carbide insert / Finishing: High-precision SUMIDIA insert
- Strong and Lightweight Body: Special aluminum alloy body. 40% lighter than steel cutters. Hard anodizing. Improved efficiency with higher spindle speeds, lower spindle loads and shorter tool change time

SUMIDIA
SUMIDIA
BINDERLESS

- Safety Design: Prevents inserts from dislodging from cutter due to centrifugal force. (Speeds must be within max. recommended conditions)
To prevent warping, wedges are not used in the cutter construction

- Easy Runout Adjustment: External setting gauge is used for easy tool presetting. High-precision cutter construction - units fitted are within 10µm runout even before setting

SUMICRYSTAL

■ Surface Finish

<ul style="list-style-type: none"> · Process: Finish Milling · Machine: Vertical Machining Centre · Arbor: HSK63A · Work Material: Si 10 to 12% Al Alloy · Cutter: RF4100R 6-Tooth (1 Wiper) · Grade: SUMIDIA (DA1000) 	<ul style="list-style-type: none"> · $vc = 4,990\text{m/min}$ · $n = 15,900\text{min}^{-1}$ · $vf = 11,400\text{mm}^3/\text{min}$ · $fz = 0.12\text{mm/t}$ · $ap = 0.5\text{mm}$, Wiper $ap = 0.03\text{mm}$, Dry
--	--

Rz (Highest Peak): 0.69µm Ra: 0.092µm

C

D

S

T

V

W

■ Structure of RF type

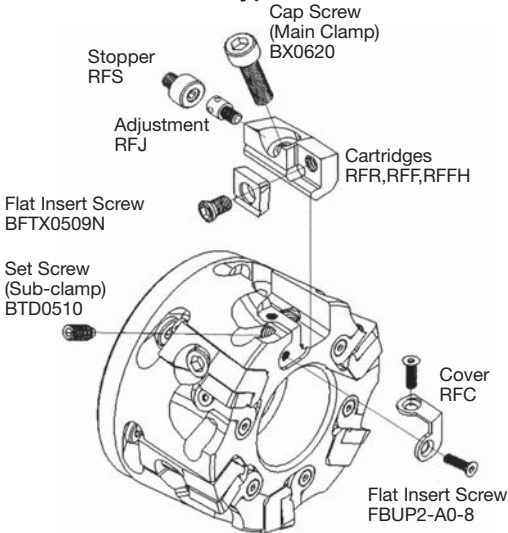

● Maximum Allowable Spindle Speed

Cat. No.	n max (min ⁻¹)
RF4080R	17,000
RF4100R	15,900
RF4125R	13,500
RF4160R	11,000
RF4200R	9,000
RF4250R	7,600
RF4315R	6,000

* The maximum allowable spindle speeds are set to prevent the inserts from dislodging by centrifugal force.

■ Recommended Cutting Conditions

Si content of 12% or less

ISO	Work Material	Cutting Speed vc (m/min) Min. - Optimum - Max.	Feed Rate fz (mm/t) Min. - Optimum - Max.	Insert Grade
N	Aluminum Alloy	2,000-2,500-3,000	0.05-0.13-0.20	DA1000 DA2200
		300-650-1,000	0.05-0.13-0.20	H1

Note · The above are the recommended conditions for RF type overall. Use within the maximum allowable spindle speed.
· The cutting conditions are a guide. Actual conditions will need to be adjusted according to machine rigidity, work clamp rigidity, depth of cut and other factors.

Si content of over 12%

ISO	Work Material	Cutting Speed vc (m/min) Min. - Optimum - Max.	Feed Rate fz (mm/t) Min. - Optimum - Max.	Insert Grade
N	Aluminum Alloy	400-600-800	0.05-0.13-0.20	DA1000 DA2200
		200-300-400	0.05-0.13-0.20	H1

Note The cutting conditions above are a guide. Actual conditions will need to be adjusted according to machine rigidity, work clamp rigidity, depth of cut and other factors.

● Recommended Cutting Edge Position

We recommend positioning as in the figure below when mounting carbide inserts or SUMIDIA inserts (blades).

- When roughing and finishing in the same process

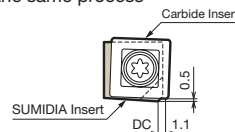

- When using wiper edge

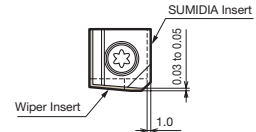

■ Product Range

Type	Cat. No.	Dia. (mm)						
		ø80	ø100	ø125	ø160	ø200	ø250	ø315
Shell	RF 4000R Inch	6	6	8	10	12	16	18

Number in ●○ shows the number of teeth Inch Inch Bore

⚠ CAUTIONS (For more details, refer to the instruction manual included with the product)

As it is possible to mix different types of inserts/blades, it is important to take note of the following.

- Do not mix reground and new inserts or inserts with a different regrinding allowance on the same cutter.
- Carbide and SUMIDIA inserts must be arranged alternately.
- When using a combination of SUMIDIA blades and inserts, ensure proper balance by mounting the same type of cutting edges on opposite sides of the cutter.

RF 4000R type



Rake Angle	Radial	4°	3mm	90°	10mm	87°	Face Milling
	Axial	10°	(SUMIDIA Insert)	(Carbide Insert)			

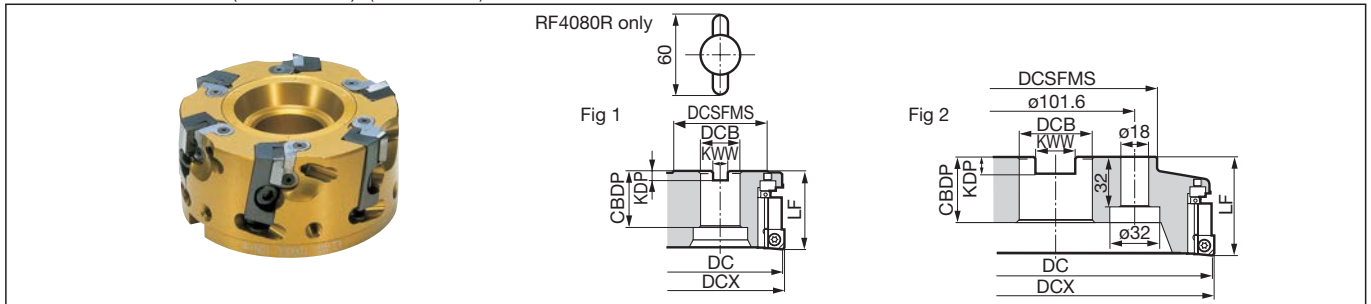

Body

												Dimensions (mm)	
Cat. No.	Stock	Dia. DC	Max. Dia. DCX	Boss DCSFMS	Overall Length LF	Hole Dia. DCB	Keyway Width KWW	Keyway Depth KDP	Mounting Depth CDBP	Number of Teeth	Weight (kg)	Fig	
RF 4080R	●	80	82	60	50	25.4	9.5	6	30	6	0.7	1	
4100R	●	100	102	75	50	31.75	12.7	8	38	6	1.0	1	
4125R	●	125	127	75	63	38.1	15.9	10	38	8	1.6	1	
4160R	●	160	162	100	63	50.8	19.1	11	38	10	2.6	1	
4200R	●	200	202	130	63	47.625	25.4	14	42	12	3.6	2	
4250R	●	250	252	130	63	47.625	25.4	14	42	16	6.0	2	
4315R	●	315	317	240	80	47.625	25.4	14	42	18	11.0	2	

Cartridges, blades and inserts are sold separately.
Use a flanged bolt to mount the cutter to the arbor.

Insert/Cartridge

Grade Classification		Cemented Carbide	DLC	SUMIDIA	SUMICRYSTAL				
Process	High-speed/Light Cutting	N	N	N	N	Refer to page M64 for details of SUMICRYSTAL.			
	General-purpose	N	N	N	N	*When using large depth of cut (ap = 3mm or longer) with RF4080R, use the RFFH cartridge. (RFF is possible for normal cutting.)			
	Roughing	N	N	N	N				
Cat. No.	H	DL1000	DA1000	DA2200	SC10	Fig	Cartridges Cat. No.	Cartridges Stock	Fig
SDET 1204ZDFR	●	●	—	—	—	3	RFR	●	1
NF-SNEW 1204ADFR	—	—	●	▲	—	4	RFF	●	2
120404ADFR-H	—	—	●	—	—	5	RFF (Others) RFFH(RF4080R)	●	2
1204ADFR-W	—	—	●	▲	—	6	RFF	●	2
SNEW 1204ADFR-WS	—	—	—	—	●	7	RFF	●	2

An "H" at the end of the part number indicates large depth of cut type, while "W" or "WS" indicates a wiper insert.

Parts

Cover	Stopper	Cap Screw	Set Screw	Flat Insert Screw	Adjustment	Flat Insert Screw	Wrench	Wrench			
		Main Clamp 	Sub-clamp 	Cover Mounting 							
RFC	RFS	BX0620	10.0	BTD 0510	3.0	FBUP2-A0-8	RFJ	BFTX 0509N	5.0	TH050 TH025 RFT	TTX20

Blades/Dummy Blades

Product Name	Cat. No.	SUMIDIA DA2200
SUMIDIA Blade	RFB	●
SUMIDIA Wiper Blade	RFBW	●
Dummy Blade	RFD	●(Steel)

Use dummy blades for unused teeth to protect the body as well as maintaining balance.

Setting Parts

Cartridge design allows inserts to be attached outside the machine with high precision.

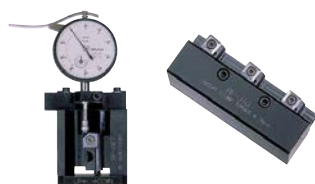

Setting Gauge RF-SET (Sold Separately/ Standard Stock)
Clamp Jig RF-JIG (Sold Separately/ Standard Stock)

*Dial gauge is not included.

Internal Coolant Attachments

For internal coolant supply, use an internal coolant holder or a commercially available clamp bolt with coolant holes. Typical examples are given in the table below. For specifications, contact each manufacturer directly.

Body Cat. No.	Internal Coolant Holder	Standard Clamp Bolt with Coolant Hole (Example)
RF 4080R	—	MBC-M12 TMBA-M12
RF 4100R	—	MBC-M16 TMBA-M16
RF 4125R	—	MBC-M20 TMBA-M20
RF 4160R	—	MBC-M24 TMBA-M24
RF 4200R	RF-CLT	—
RF 4250R	RF-CLT	—
RF 4315R	RF-CLT	—



Direction of Coolant Streams

Internal Coolant Holders RF-CLT (Standard Stock)

Standard Clamp Bolt with Coolant Hole [Typical Example] MBC-M12 to M24 (Sold Separately)

SRF series

SUMIDIA

M

SUMIDIA
SUMIDIA
BINDERLESS

SUMICRYSTAL

C

D

S

T

V

W



■ Features

The SRF type is ideal for aluminum alloy machining on high-performance small machines.

- **Ideal for small machines**
Especially reliable on BT30 class small machines.
- **From roughing to finishing processes**
Utilises SUMIDIA DA1000 inserts with effective cutting edge length of 5mm.
- **Economical NF type inserts:**
NF type SUMIDIA inserts with tough DA1000 grade lower tooling costs.
- **High-speed cutting with SUMIDIA:**
Maximum spindle speeds of up to $n = 20,000\text{min}^{-1}$
(Please operate within the maximum allowable spindle speed of the machine and holder used)
*The maximum allowable spindle speeds are set to prevent the inserts from dislodging by centrifugal force.
- **Simple runout adjustment mechanism:**
Simple direct insert mounting design with easy fine-adjustment for runout precision.

■ Recommended Cutting Conditions

Si content of 12% or less

ISO	Work Material	Cutting Speed v_c (m/min) Min. - Optimum - Max.	Feed Rate f_z (mm/t) Min. - Optimum - Max.	Insert Grade
N	Aluminum Alloy	2,000- 3,000 -4,000	0.05- 0.13 -0.20	DA1000

Note · The above are the recommended conditions for SRF type overall. Use within the maximum allowable spindle speed.
· The cutting conditions are a guide. Actual conditions will need to be adjusted according to machine rigidity, work clamp rigidity, depth of cut and other factors.

Si content of over 12%

ISO	Work Material	Cutting Speed v_c (m/min) Min. - Optimum - Max.	Feed Rate f_z (mm/t) Min. - Optimum - Max.	Insert Grade
N	Aluminum Alloy	400- 600 -800	0.05- 0.13 -0.20	DA1000

Note The cutting conditions above are a guide. Actual conditions will need to be adjusted according to machine rigidity, work clamp rigidity, depth of cut and other factors.

SRF series



Rake Angle	Radial	-2° to 4°
	Axial	6°

5mm 90°

Face Milling Shoulder Milling

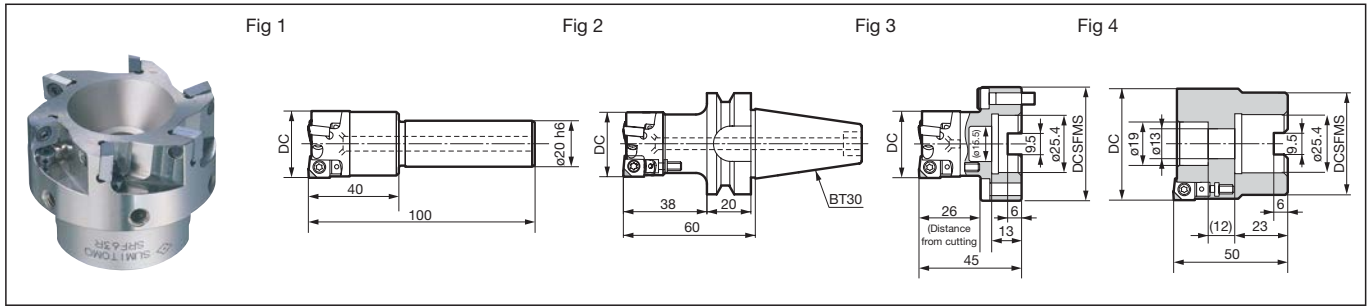

Body

Cat. No.		Stock	Dimensions (mm)				Fig
			Dia. DC	Boss DCSFMS	Number of Teeth	Weight (kg)	
Inch	SRF 30R-ST	●	30	—	3	0.34	1
	40R-ST	●	40	—	4	0.50	1
	SRF 30R-BT30	●	30	—	3	0.57	2
	40R-BT30	●	40	—	4	0.72	2
	SRF 30R	●	30	50.0	3	0.27	3
	40R	●	40	50.0	4	0.35	3
	50R	●	50	46.5	5	0.59	4
	63R	●	63	45.0	6	0.67	4

Inserts are sold separately.

Product Range

Type	Cat. No.	Dia. (mm)			
		ø30	ø40	ø50	ø63
Shell	SRF 30R(-ST)	3			
	SRF 40R(-ST)		4		
	SRF 30R-BT30	3			
	SRF 40R-BT30		4		
	SRF 50R <small>inch</small>			5	
	SRF 63R <small>inch</small>				6

Number in ● shows the number of teeth inch Inch Bore

Note For mounting the cutters marked with * to an arbor, use a hex socket bolt (JIS B1176) M12 x 30 to 35mm.

Insert

Grade Classification		SUMIDIA		Cutting Edge Shape	Fig
Process		N	N		
	High-speed/Light Cutting	N	N		
	General-purpose	N	N		
	Roughing	N	N		
Cat. No.	DA1000	DA2200			
NF-SNEW 09T3ADTR	●	▲	Standard	1	
09T3ADTR-U	●	▲	Wiper Flat	2	
09T3ADTR-R	●	▲	Corner Radius	3	

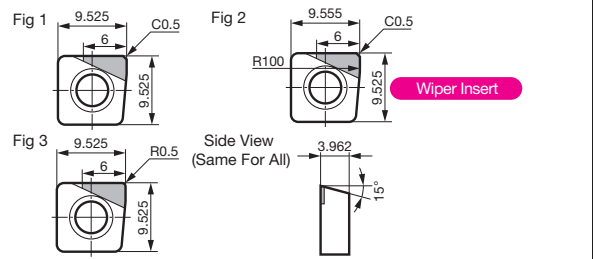

Recommended Cutting Conditions **M52**

- Standard inserts and wiper inserts can be used on the same cutter body.
- Standard inserts with corner radius should be used where chatter is present. These cannot be used with wiper inserts.
- Inserts can be reground 3 times (up to minimum IC diameter of 9.225mm), but the cutting edge height changes by the reground amount.
- Do not mix new and reground inserts or inserts with different regrind amounts on the same cutter.
- When using reground inserts, it is advisable to re-confirm cutting edge position with a tool pre-setter.
- Arbor for SRF30R, SRF40R

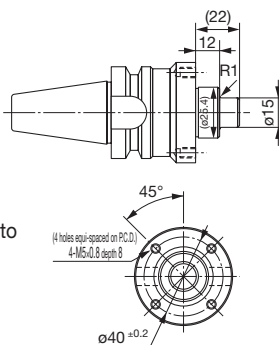

When using SRF30R and SRF40R cutters, the arbor needs to be modified as shown above.

(1. Reduce part of the arbor's adapter shaft length from ø25.4 to ø15. 2. Add 4 tap holes for (M5) mounting bolts.) Use hex socket bolts M5 x 20mm for securing the body.

Parts

Flat Insert Screw	Adjustment Screw	Wrench
BFTX0409N	SRFJ	TH015 TTX15W

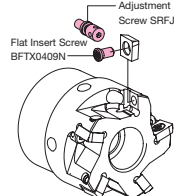

Maximum Depth of Cut (SRF50R, 5-Tooth)

The table below contains guidelines on the maximum depth of cut, determined from internal tests. 'O' marks indicate the possible application range. Actual cutting conditions should be set based on the actual machine and workpiece characteristics.

Depth of Cut ap (mm)	Feed Rate	Feed Rate (vf) (mm/min)		
		2,500	4,000	5,000
		Feed Rate Per Tooth fz (mm/t)		
		0.05	0.08	0.10
0.5		○	○	○
1.0		○	○	○
1.5		○	○	○
2.0		○	○	○
2.5		○	○	○
3.0		○	○	○
3.5		○	○	○
4.0		○	—	—
4.5		○	—	—
5.0		○	—	—

Cutting Conditions

Cutter : SRF50R
 Insert : NF-SNEW 09T3ADTR (DA1000)
 n = 10,000min⁻¹
 Arbor : BT30 FMA25.4-45
 Workpiece : A-5052
 Width : Maximum depth of cut at 35mm

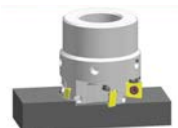

Rake Angle	Radial	+4°	+6°		
Angle	Axial	+13°	+10°		
		(FAM series)	(SAM series)	FAM	SAM

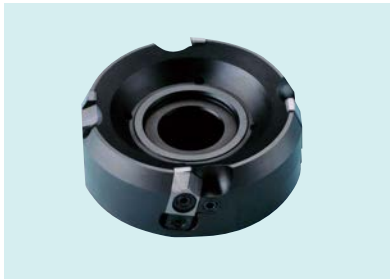

■ Features

- Optimized cutting edge design for excellent cutting performance in the machining non-ferrous metals such as aluminum alloys.
- Blade runout can be adjusted to improve the quality of the machined surface finish.
- High rigidity body with blades mounted firmly by double-clamp allow its used in roughing processes.

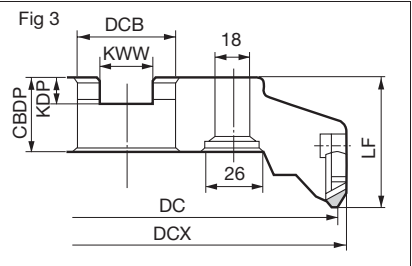
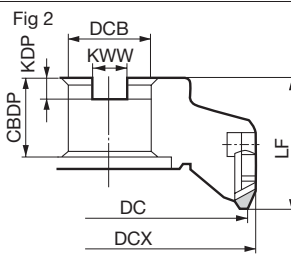
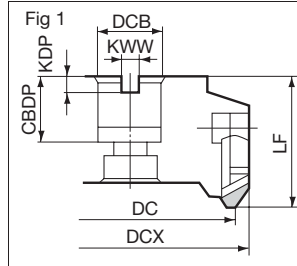
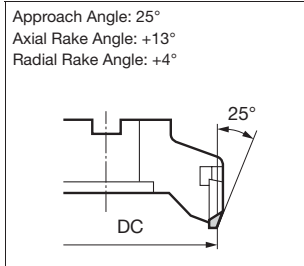

Body (FAM series)

Dimensions (mm)

Cat. No.	Stock		Dia. DC	Max. Dia. DCX	Height LF	Bore Dia. DCB	Mounting Depth CDBP	Keyway Width KWW	Keyway Depth KDP	Number of Teeth	Weight (kg)	Fig
	R	L										
FAM080 R/L			80	92	50	25.4	25	9.5	6	4	2.1	1
FAM100 R/L			100	112	50	31.75	32	12.7	8	4	2.9	2
125 R/L			125	137	63	38.1	38	15.9	10	5	3.8	2
160 R/L			160	171	63	50.8	38	19.1	11	6	6.6	2
FAM200 R/L			200	210	63	47.625	38	25.4	14	8	9.9	3
250 R/L			250	260	63	47.625	40	25.4	14	10	16.0	3
315 R/L			315	325	63	47.625	40	25.4	14	12	25.1	3

Inserts are sold separately.

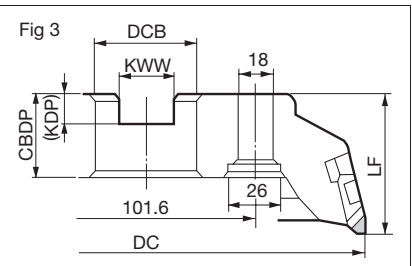
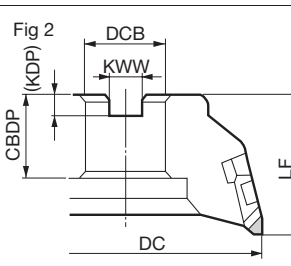
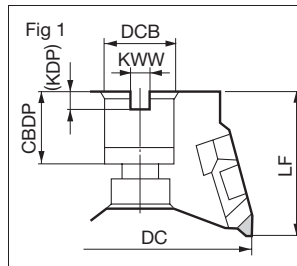
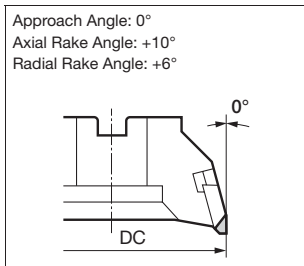

Body (SAM series)

Dimensions (mm)

Cat. No.	Stock		Dia. DC	Height LF	Bore Dia. DCB	Mounting Depth CDBP	Keyway Width KWW	Keyway Depth KDP	Number of Teeth	Weight (kg)	Fig
	R	L									
SAM080 R/L			80	50	25.4	25	9.5	6	4	1.6	1
SAM100 R/L			100	50	31.75	32	12.7	8	4	2.3	2
125 R/L			125	63	38.1	38	15.9	10	5	3.7	2
160 R/L			160	63	50.8	38	19.1	11	6	5.9	2
SAM200 R/L			200	63	47.625	38	25.4	14	8	8.5	3
250 R/L			250	63	47.625	40	25.4	14	10	114.3	3
315 R/L			315	63	47.625	40	25.4	14	12	30.3	3

Inserts are sold separately.

● Refer to M54 for blades, parts and recommended cutting conditions.

It is possible to design the FAM/SAM series cutters in 2 teeth/inch or multi-teeth configurations.

DFE series

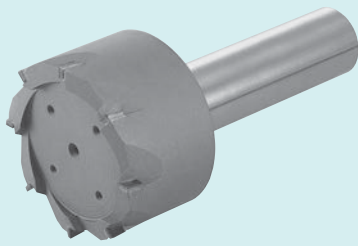

■ Features

- Supports small machines. Small diameter shank type cutter.
- Multiple brazed teeth for high feed milling.
- With excellent fracture resistance and sharpness, DA2200 is optimal for milling of aluminum and non-ferrous metals.
- Through-tool oil holes for high speed machining.

■ Body

Fig 1



Fig 2

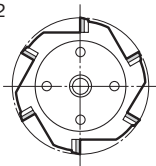
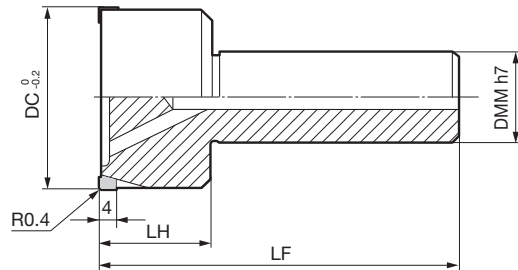
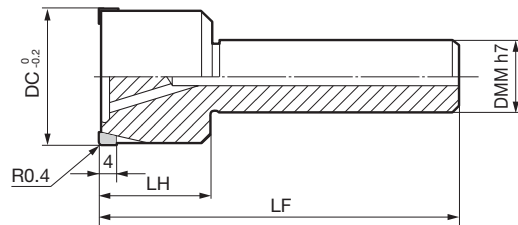
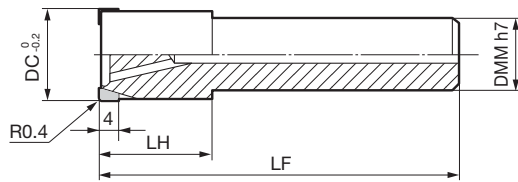
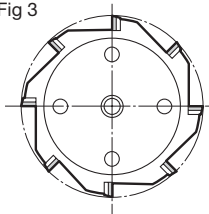

Fig 3



Dimensions (mm)

Cat. No.	DA2200	Dia. DC	Overall Length LF	Head LH	Shank Dia. DMM	Number of Teeth	Fig
DFE 4200GS	●	20	80	25	16	4	1
DFE 6250GS	●	25	80	25	16	6	2
6300GS	●	30	80	25	16	6	2
DFE 8400GS	●	40	80	25	16	8	3
8500GS	●	50	80	25	20	8	3

■ Recommended Cutting Conditions

Tooling	ISO	Work Material	Cutting Speed v_c (m/min)	Feed Rate f_z (mm/t)	Insert Grade
			Min. - Optimum - Max.	Min. - Optimum - Max.	
	N	Aluminum Alloy	200-800-2,000	0.02-0.05-0.10	DA2200

■ Application Examples

	Work Material	Cutting Conditions	Results
	ADC12 Aluminum Alloy	Tool: DFE8400GS	· Good machined surface as burrs do not occur.
	Motor Casing Part	Cutting Conditions: $v_c = 1,500\text{m/min}$ $n = 11,940\text{min}^{-1}$ $f_z = 0.03\text{mm/t}$ $v_f = 2,865\text{mm/min}$ $ap = 0.5\text{mm}$ Wet	· More cutting teeth than indexable type cutters, and cycle time is much shorter.

SUMIDIA

M

SUMIDIA
SUMIDIA
BINDERLESS

SUMICRYSTAL

C

D

S

T

V

W



General Features

SUMIDIA BINDERLESS is polycrystalline diamond that directly binds nano-sized diamond particles with high strength without using any binders. Harder than single-crystal diamond, it has no cleavability, enabling machining of hard brittle materials such as Cemented Carbide and making new machining methods possible.

Features

- Ideal for Finishing of Hard Brittle Materials Including Cemented Carbide
Provides excellent machined surface quality thanks to a sharp cutting edge and optimised edge treatment.
- Enables High-precision Machining and Achieves Long Tool Life
Maintains excellent dimensional tolerance for a long time thanks to the high contour accuracy of the cutting edge and excellent wear resistance of the diamond material.

SUMIDIA BINDERLESS Radius Endmills

NPDRS series

For Surface Milling and Rounded Base Milling

SUMIDIA BINDERLESS Ballnose Endmills

NPDBS series / NPDB series

For Spherical Milling

Pocketing

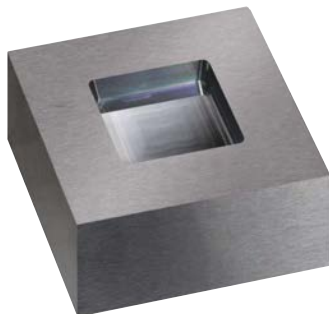

Work Material	: Carbide AF1 (Ultra-Fine Grained Carbide)
Tool Used	: NPDRS1100R005-030
Cutting Conditions	: 10mm × 10mm × Depth 2mm
	: n = 40,000min ⁻¹ , vf = 200mm/min
	pf = 0.005mm, Oil Mist
Surface Roughness	: Ra 0.015μm
Cutting Time	: 2 Hours

Application to Optical Use (Fly-Eye Lens Mold)



Work Material	: Carbide AF1 (Ultra-Fine Grained Carbide)
Tool	: Finishing NPDB 1050-020 (R0.5)
Roughing	: Diamond-Coated Endmill (R0.5)
Cutting Conditions	: n = 60,000min ⁻¹ , vf = 300mm/min
	pf = 0.005mm, Oil Mist
Surface Roughness	: Ra 0.015μm
Cutting Time	: Finishing 2 Hours 40 Minutes
	Roughing 55 Minutes

SUMIDIA
M
SUMIDIA BINDERLESS
SUMICRYSTAL
C
D
S
T
V
W

NPDRS type

Cemented Carbide Hard Brittle Material

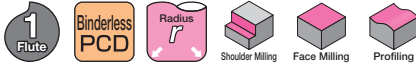
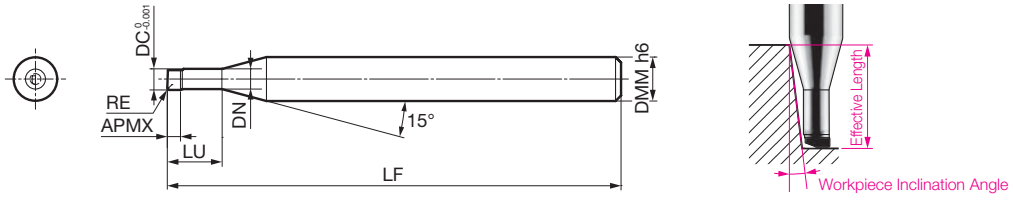

Fig 1



Body Dimensions (mm)

Cat. No.	Stock	Dia. DC	Corner Radius RE	Cutting Edge Length APMX	Neck Length LU	Overall Length LF	Neck Dia. DN	Shank Dia. DMM	Effective Length for Workpiece Inclination Angle					Wiper Edge	Fig
									0.5°	1°	1.5°	2°	3°		
NPDRS 1020R002-006	●	0.2	0.02	0.1	0.6	40	0.175	4	0.63	0.65	0.67	0.70	0.75	No	1
1020R005-006	●	0.2	0.05	0.1	0.6	40	0.175	4	0.63	0.65	0.67	0.69	0.74	No	1
1030R002-010	●	0.3	0.02	0.15	1.0	40	0.27	4	1.04	1.08	1.11	1.15	1.24	No	1
1030R005-010	●	0.3	0.05	0.15	1.0	40	0.27	4	1.04	1.08	1.11	1.15	1.23	No	1
1050R005-015	●	0.5	0.05	0.25	1.5	40	0.47	4	1.56	1.61	1.66	1.72	1.84	No	1
NPDRS 1050R010-015	●	0.5	0.10	0.25	1.5	40	0.47	4	1.56	1.60	1.65	1.71	1.83	No	1
1100R005-030	●	1.0	0.05	0.55	3.0	40	0.95	4	3.14	3.24	3.35	3.46	3.72	No	1
1100R010-030	●	1.0	0.10	0.55	3.0	40	0.95	4	3.14	3.24	3.34	3.46	3.71	No	1
1100R020-030	●	1.0	0.20	0.55	3.0	40	0.95	4	3.14	3.23	3.33	3.44	3.69	No	1
1200R005-040	●	2.0	0.05	0.55	4.0	40	1.95	4	4.17	4.31	4.45	4.60	4.94	No	1
NPDRS 1200R010-040	●	2.0	0.10	0.55	4.0	40	1.95	4	4.17	4.30	4.44	4.60	4.93	No	1
1200R020-040	●	2.0	0.20	0.55	4.0	40	1.95	4	4.17	4.30	4.43	4.58	4.91	No	1

Grade: NPD10

Identification Code

NPDR S 1 020 R002 - 006

Series Code For No. of Dia. Corner Radius Neck Length
Standard Flutes Finishing

Recommended Cutting Conditions

- Use a machine with high accuracy for stable cutting.
- Non-water soluble coolant recommended. Supply as a mist or external coolant.
Take fire prevention precautions to avoid fire hazards caused by sparks igniting during machining or tool breakage.
- Shorten overhang as much as possible.
- Adjust cutting conditions as necessary as machine specs and other conditions may vary.
- The cutting parameters shown are for reference only. Adjust the cutting conditions to the desired machined surface finish.

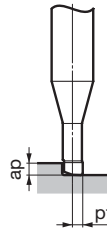

Work Material		Cemented Carbide			
DC (mm)	LU (mm)	Spindle Speed (min ⁻¹)	Feed Rate (mm/min)	ap(mm)	pf(mm)
0.2	0.6	40,000	100	0.001	0.001
0.3	1.0	40,000	150	0.002	0.001
0.5	1.5	40,000	200	0.003	0.001
1.0	3.0	40,000	400	0.005	0.003
2.0	4.0	40,000	600	0.010	0.005

SUMIDIA

M

SUMIDIA BINDERLESS

SUMICRYSTAL

C

D

S

T

V

W

NPDBS type

Cemented Carbide Hard Brittle Material

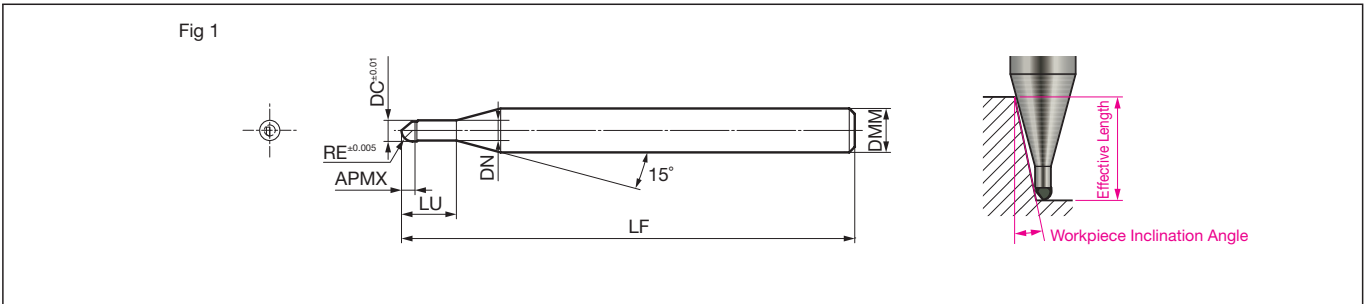

Body (for Standard Finishing)

Cat. No.	Stock	Ballnose Radius RE	Dia. DC	Cutting Edge Length APMX	Neck Length LU	Overall Length LF	Neck Dia. DN	Shank Dia. DMM	Effective Length for Workpiece Inclination Angle					Fig
									0.5°	1°	1.5°	2°	3°	
NPDBS 1010-004	●	0.1	0.2	0.1	0.4	40	0.18	4	0.42	0.43	0.44	0.46	0.48	1
1020-008	●	0.2	0.4	0.2	0.8	40	0.38	4	0.83	0.85	0.87	0.90	0.95	1
1030-010	●	0.3	0.6	0.3	1.0	40	0.58	4	1.03	1.06	1.08	1.11	1.17	1
1050-020	●	0.5	1.0	0.5	2.0	40	0.95	4	2.10	2.15	2.20	2.26	2.39	1
1100-030	●	1.0	2.0	1.0	3.0	40	1.95	4	3.11	3.18	3.25	3.33	3.51	1

Grade: NPD10

Identification Code

NPDB S 1 010 - 004

Series Code For No. of Ballnose Neck
Standard Flutes Radius Length
Finishing

Recommended Cutting Conditions

1. Use a machine with high accuracy for stable cutting.
2. Non-water soluble coolant recommended. Supply as a mist or external coolant.
Take fire prevention precautions to avoid fire hazards caused by sparks igniting during machining or tool breakage.
3. Shorten overhang as much as possible.
4. Adjust cutting conditions as necessary as machine specs and other conditions may vary.
5. The cutting parameters shown are for reference only. Adjust the cutting conditions to the desired machined surface finish.

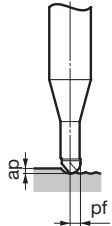

Work Material		Cemented Carbide			
RE (mm)	LU (mm)	Spindle Speed (min ⁻¹)	Feed Rate (mm/min)	ap(mm)	pf(mm)
0.1	0.4	40,000	100	0.001	0.001
0.2	0.8	40,000	150	0.002	0.001
0.3	1.0	40,000	200	0.003	0.001
0.5	2.0	40,000	400	0.005	0.003
1.0	3.0	40,000	600	0.010	0.005

* Radius accuracy inspection report is included inside the case. I135
* Long neck type is also available depending on the size. Please consult us separately.

SUMIDIA
M
SUMIDIA
BINDERLESS
SUMICRYSTAL
C
D
S
T
V
W

NPDB type

Cemented Carbide Hard Brittle Material



Fig 1

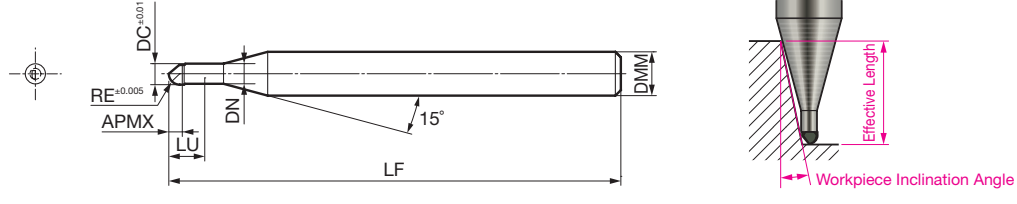

Body (for Precise Finishing)

Dimensions (mm)

Cat. No.	Stock	Ballnose Radius RE	Dia. DC	Cutting Edge Length APMX	Neck Length LU	Overall Length LF	Neck Dia. DN	Shank Dia. DMM	Effective Length for Workpiece Inclination Angle					Fig
									0.5°	1°	1.5°	2°	3°	
NPDB 1010-004	●	0.1	0.2	0.1	0.4	40	0.18	4	0.42	0.43	0.44	0.46	0.48	1
1020-008	●	0.2	0.4	0.2	0.8	40	0.38	4	0.83	0.85	0.87	0.90	0.95	1
1030-010	●	0.3	0.6	0.3	1.0	40	0.58	4	1.03	1.06	1.08	1.11	1.17	1
1050-020	●	0.5	1.0	0.5	2.0	40	0.95	4	2.10	2.15	2.20	2.26	2.39	1
1100-030	●	1.0	2.0	1.0	3.0	40	1.95	4	3.11	3.18	3.25	3.33	3.51	1

Grade: NPD10

Identification Code

NPDB 1 010 - 004

Series Code No. of Flutes Ballnose Radius Neck Length

Recommended Cutting Conditions

1. Use a machine with high accuracy for stable cutting.
2. Non-water soluble coolant recommended. Supply as a mist or external coolant.
Take fire prevention precautions to avoid fire hazards caused by sparks igniting during machining or tool breakage.
3. Shorten overhang as much as possible.
4. Adjust cutting conditions as necessary as machine specs and other conditions may vary.
5. The cutting parameters shown are for reference only. Adjust the cutting conditions to the desired machined surface finish.

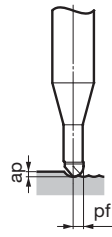

Work Material		Cemented Carbide			
RE (mm)	LU (mm)	Spindle Speed (min ⁻¹)	Feed Rate (mm/min)	ap (mm)	pf (mm)
0.1	0.4	40,000	100	0.001	0.001
0.2	0.8	40,000	150	0.002	0.001
0.3	1.0	40,000	200	0.003	0.001
0.5	2.0	40,000	400	0.005	0.003
1.0	3.0	40,000	600	0.010	0.005

* Radius accuracy inspection report is included inside the case. **ISO 1135**
 * Long neck type is also available depending on the size. Please consult us separately.

SUMIDIA Endmills

DFE series

Aluminum Alloy Copper Alloy Graphite



Fig 1

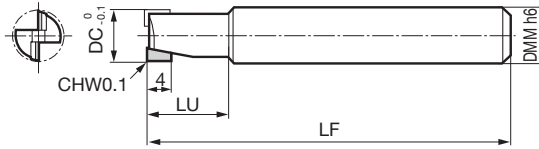

Body

Dimensions (mm)

Cat. No.	Stock	Dia. DC	Neck Length LU	Overall Length LF	Shank Dia. DMM	Fig
DFE 2040S	●	4.0	15	50	6	1
2050S	●	5.0	15	50	6	1
2080S	●	8.0	15	60	10	1
2090S	●	9.0	15	70	10	1
2100S	●	10.0	15	70	10	1

Grade: DA2200

Recommended Cutting Conditions

1. If the machine cannot achieve the recommended spindle speed, please use the maximum spindle speed available.
2. If cutting noise and vibration occur, please reduce the cutting conditions accordingly.

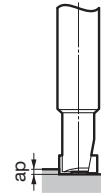

Face Milling (2 Flutes)

Work Material Cutting Conditions	Aluminum Alloy Copper Alloy	
	Spindle Speed (min ⁻¹)	Feed Rate (mm/min)
DC(mm)		
4.0	40,000	4,000
5.0	32,000	3,200
8.0	20,000	2,000
9.0	17,800	1,780
10.0	16,000	1,600
Standard Depth of Cut	ap	0.4DC



Fig 1

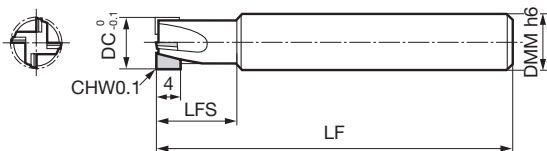
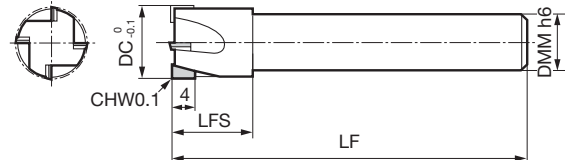

Fig 2



Body

Dimensions (mm)

Cat. No.	Stock	Dia. DC	Neck Length LFS	Overall Length LF	Shank Dia. DMM	Fig
DFE 4090S	●	9.0	15	70	10	1
4100S	●	10.0	15	70	10	1
4130GS	●	13.0	15	70	10	2

Grade: DA2200

Recommended Cutting Conditions

1. If the machine cannot achieve the recommended spindle speed, please use the maximum spindle speed available.
2. If cutting noise and vibration occur, please reduce the cutting conditions accordingly.

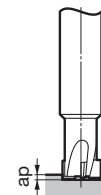

Face Milling (4 Flutes)

Work Material Cutting Conditions	Aluminum Alloy Copper Alloy	
	Spindle Speed (min ⁻¹)	Feed Rate (mm/min)
DC(mm)		
9.0	17,800	3,560
10.0	16,000	3,200
13.0	12,300	2,460
Standard Depth of Cut	ap	0.4DC

SUMIDIA
M
SUMIDIA
BINDERLESS
SUMICRYSTAL
C
D
S
T
V
W

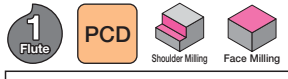
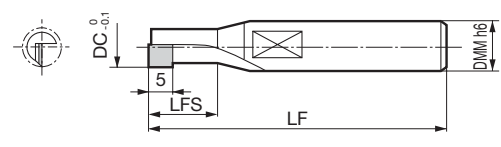

Fig 1



Body

Dimensions (mm)

Cat. No.	Stock	Dia. DC	Neck Length LFS	Overall Length LF	Shank Dia. DMM	Fig
DAE 1040	●	4.0	10	45	6	1
1050	●	5.0	12	50	6	1

Grade: DA200

Recommended Cutting Conditions

- If the machine cannot achieve the recommended spindle speed, please use the maximum spindle speed available.
- If cutting noise and vibration occur, please reduce the cutting conditions accordingly.

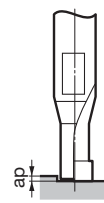

Face Milling (1 Flutes)

Cutting Conditions	Work Material	
	Aluminum Alloy Copper Alloy	
DC(mm)	Spindle Speed (min ⁻¹)	Feed Rate (mm/min)
4.0	6,000	210
5.0	5,000	175
Standard Depth of Cut	ap 0.4DC	

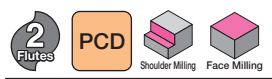
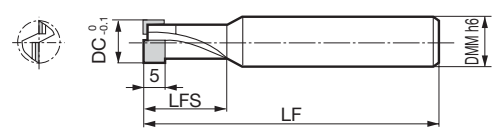

Fig 1



Body (2 Flutes)

Dimensions (mm)

Cat. No.	Stock	Dia. DC	Neck Length LFS	Overall Length LF	Shank Dia. DMM	Fig
DAE 2060	●	6.0	20	50	6	1
2070	●	7.0	20	60	8	1
2080	●	8.0	20	60	8	1
2090	●	9.0	25	71	10	1
2100	●	10.0	25	71	10	1
DAE 2110	●	11.0	25	75	12	1
2120	●	12.0	25	75	12	1

Grade: DA200

Recommended Cutting Conditions

- If the machine cannot achieve the recommended spindle speed, please use the maximum spindle speed available.
- If cutting noise and vibration occur, please reduce the cutting conditions accordingly.

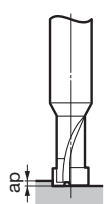

Face Milling (2 Flutes)

Cutting Conditions	Work Material	
	Aluminum Alloy Copper Alloy	
DC(mm)	Spindle Speed (min ⁻¹)	Feed Rate (mm/min)
6.0	6,400	580
7.0	5,500	500
8.0	5,400	500
9.0	5,300	480
10.0	4,800	440
11.0	4,400	400
12.0	4,000	360
Standard Depth of Cut	ap 0.4DC	

SUMIDIA

M

SUMIDIA
SUMIDIA
BINDERLESS

SUMICRYSTAL

C

D

S

T

V

W



From General to High Precision Drilling of Aluminum Alloys

- High precision DAL series is able to produce holes of IT Class of 7 to 8.
- General DDL series is able to produce holes of IT class 11 to 12, mainly for pre-tap hole drilling.

DAL series

*Refer to N36 for the tolerance of m5, h8 Dimensions (mm)

Grade Classification		SUMIDIA				
Process	High-speed/Light Cutting	N				
	General-purpose					
	Roughing					
Cat. No.	DA2200	Dia. (Shank Dia.) DC(DCON)	Flute Length LCF	Overall Length OAL	Tip PL	Fig
DAL 0500H to 0600H		$\phi 5 \leq DC \leq \phi 6$	31.6	81.6	1.6	1
0601H to 0700H		$\phi 6 < DC \leq \phi 7$	36.9	91.9	1.9	1
0701H to 0800H		$\phi 7 < DC \leq \phi 8$	37.2	92.2	2.2	1
0801H to 0900H		$\phi 8 < DC \leq \phi 9$	42.5	102.5	2.5	1
0901H to 1000H		$\phi 9 < DC \leq \phi 10$	42.8	102.8	2.8	1
1001H to 1100H		$\phi 10 < DC \leq \phi 11$	53.1	113.1	3.1	1
1101H to 1200H		$\phi 11 < DC \leq \phi 12$	53.4	113.4	3.4	1

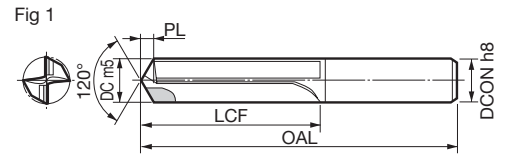

Ordering numbers should be handled according to this example: $\phi 6.05\text{mm}$ drill \rightarrow DAL0605H.

DDL series

*Refer to N36 for the tolerance of h8 Dimensions (mm)

Grade Classification		SUMIDIA				
Process	High-speed/Light Cutting	N				
	General-purpose					
	Roughing					
Cat. No.	DA2200	Dia. (Shank Dia.) DC(DCON)	Flute Length LCF	Overall Length OAL	Tip PL	Fig
DDL 050V to 060V		$\phi 5 \leq DC \leq \phi 6$	31.5	81.0	1.0	1
061V to 070V		$\phi 6 < DC \leq \phi 7$	36.2	91.2	1.2	1
071V to 080V		$\phi 7 < DC \leq \phi 8$	36.4	91.4	1.4	1
081V to 090V		$\phi 8 < DC \leq \phi 9$	41.6	101.6	1.6	1
091V to 100V		$\phi 9 < DC \leq \phi 10$	41.7	101.7	1.7	1
101V to 110V		$\phi 10 < DC \leq \phi 11$	51.9	111.9	1.9	1
111V to 120V		$\phi 11 < DC \leq \phi 12$	52.1	112.1	2.1	1

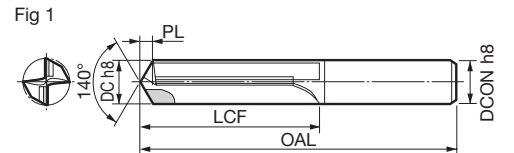

Ordering numbers should be handled according to this example: $\phi 10.5\text{mm}$ drill \rightarrow DDL105V.

Recommended Cutting Conditions

(n: Spindle Speed min^{-1} vc: Cutting Speed m/min f: Feed Rate mm/rev)

Diameter DC (mm)	Cutting Conditions	DAL series	DDL series	Depth of Cut	Oil
$\phi 8.0$	n	4,000	8,000	L/D= Below 3	Emulsion type
	vc	80 - 100 - 150	150 - 200 - 250		
	f	0.05 - 0.1 - 0.15	0.1 - 0.15 - 0.25		
$\phi 12.0$	n	2,700	5,300		
	vc	80 - 100 - 150	150 - 200 - 250		
	f	0.08 - 0.13 - 0.2	0.15 - 0.2 - 0.3		

Min. - **Optimum** - Max.

Important Notes

- When using DAL series for high-precision machining, select a high rigidity machine and high precision holder.
- Supply coolant generously at the entrance of the hole.

SUMIDIA
SUMIDIA
BINDERLESS
SUMICRYSTAL
C
D
S
T
V
W