

# SEC-**GOALMILL** Series

Rev. 7

## High Feed Cutters for Cast Iron

### SEC-**GOALMILL** Series



**GFX** Finishing  
ø80 mm to ø315 mm

**GFS** Finishing/Shoulder Milling  
ø80 mm to ø160 mm

**GRHN** Roughing  
ø80 mm to ø315 mm

SEC-Goal Mill cutters use screw-locked tangentially mounted inserts developed for high-efficiency machining and finishing of cast iron parts





## General Features



SEC-Goal Mill Series cutters have been developed for high-efficiency machining and finishing of cast iron parts (such as engine cylinder blocks and transmission cases).

## Features

- Special cutters for high-feed machining of cast iron
- Multi-teeth design (approx. 3 teeth per inch)
- Finishing cutters feature an easy-to-use function for fine edge runout adjustment
- Highly reliable cutter with tangential inserts for finishing
- Chipbreaker type inserts for low cutting force

## Product Range

Series Code	GFX	GFS	GRHN
Applications	Finishing	Finishing/Shoulder Milling	Roughing
Surface Roughness	< Ra3.2	< Ra3.2	< Ra12.5
Appearance	 →P4, P5	 →P6	 →P7, P8

Work Material	Application	High-speed Finishing	Finishing to General Cutting	Interrupted Cutting	Applicable Cutter
	Finishing	BN7000			GFX Type GFS Type
		ACK260		ACK280	
	Roughing	ACK100			GRHN Type
		ACK200		ACK300	

## Grade Characteristic Values

Work Material	Grades	Hardness	Transverse Rupture Strength (GPa)	Coating Layer	Coating Thickness (μm)	Features	
	Coated Carbide	ACK100	92.0HRA	2.4	Super FF Coat	6	·Adopts a high-strength ultra-hard substrate and Super FF Coat, for a high-speed milling grade with excellent wear resistance.
		ACK200	91.7HRA	2.5	Super FF Coat	6	·A grade that employs a tough carbide substrate and thin Super FF Coat to provide superior thermal crack and wear resistance.
		ACK260	92.6HRA	2.6	Super ZX Coat	3	·From finishing to general machining of cast iron and ductile cast iron. ·Employs new super multi-layered PVD coating consisting of nanometre-thin layers of TiAlN and AlCrN coupled with a tough, thermal-resistant substrate for long and stable tool life.
		ACK280	91.7HRA	3.0	Super ZX Coat	3	·For heavy interrupted cutting and wet cutting of cast iron and ductile cast iron. ·Employs new super multi-layered PVD coating consisting of nanometre-thin layers of TiAlN and AlCrN coupled with an ultra-tough substrate for superior fracture resistance and thermal crack resistance during wet cutting.
		ACK300	91.4HRA	3.3	Super ZX Coat	3	·General to interrupted machining of cast iron and ductile cast iron. ·Employs PVD coating consisting of multiple nanometre-thin layers. Provides excellent fracture resistance when combined with a fine-grained tough substrate.
	CBN	BN7000	41.0HV to 44.0HV	1.8 to 1.9	—	—	·Exhibits wear and fracture resistance in cutting of cast iron and exotic alloys.

## GFX Type Features

### ● Simple Runout Adjustment

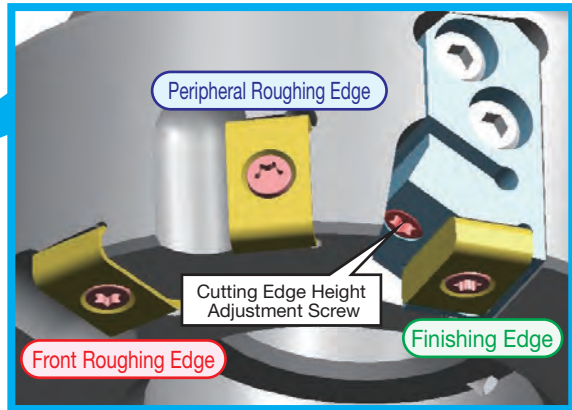
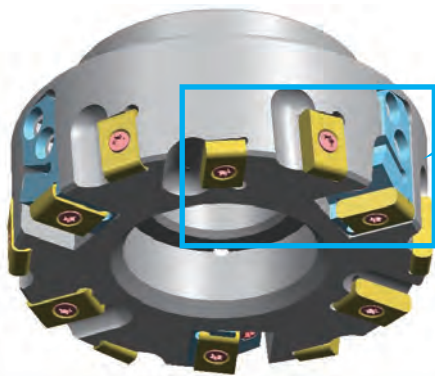

Finishing edge runout can be adjusted by 5  $\mu\text{m}$  or less simply by turning the adjustment screw.

### ● Economical 8-Cornered Insert

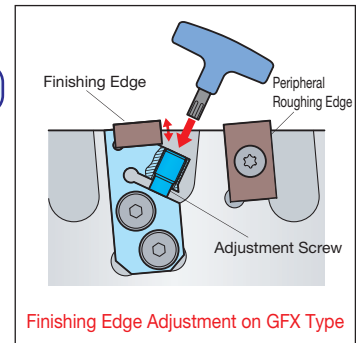
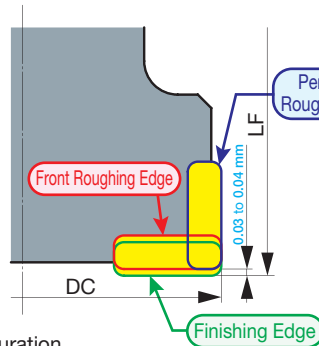
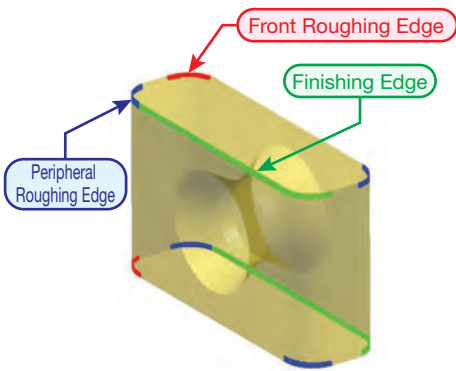

Orientating an insert in an array of vertical and horizontal positions achieves 8-cornered edge configuration.

## GFX Type Finishing Edge Runout Adjustment Procedure

<p><b>(1) Insert Assembly</b></p> <p>Mount insert on to the cutter body. When doing so, check that the cartridge adjustment screw is completely loose.</p>		<p><b>(4) Adjust Finishing Edge Height</b></p> <p>Select a finishing edge and adjust with the adjustment screw so that the edge protrudes around 0.03 to 0.04 mm further than (3).</p>	
<p><b>(2) Check Roughing Edge Runout</b></p> <p>Measure face runout of the roughing edges and check the cutting edge that protrudes the most.</p>		<p><b>(5) Adjust Runout</b></p> <p>With the finishing edge from (4) as a reference, adjust the position of the other finishing edges so that runout is equal to or less than 5 <math>\mu\text{m}</math>.</p>	
<p><b>(3) Set Reference Roughing Edge</b></p> <p>Set "0" as the cutting edge height checked in (2).</p>		<p><b>!</b></p> <ul style="list-style-type: none"> <li>Always adjust finishing edge height before use.</li> <li>Using the tool with the adjustment screw loose may result in tool breakage.</li> </ul> <p>* Adjusting finishing edge runout to 2 <math>\mu\text{m}</math> or less will result in a better machined surface.</p>	

Expansion	Rake	Radial	-8°	1 mm	89° to 89°30'
	Angle	Axial	-5°		

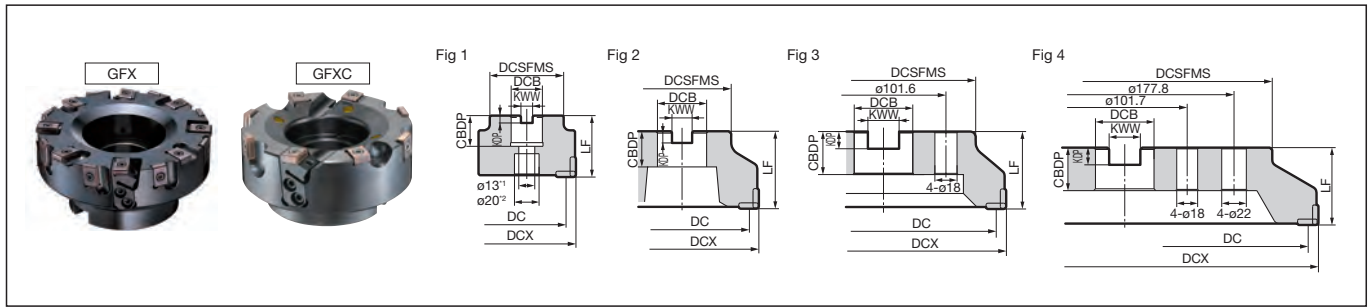

### Body (GFX 13000 Type)

Dimensions (mm)

Cat. No.	Stock		Max. Dia.	Dia.	Boss	Height	Bore Dia.	Keyway Width	Keyway Depth	Mounting Depth	Total No. of Teeth	No. of Finishing Teeth	Effective No. of Teeth	Weight (kg)	Fig
	R	L	DCX	DC	DCSFMS	LF	DCB	KWW	KDP	CBDP					
<b>GFX 13080R/L</b>	●		*80	67.3	60	50	25.4	9.5	6	25	8	2	8	1.4	1
<b>13100R/L</b>	●		100	87.3	70	50	31.75	12.7	8	32	12	3	12	1.9	2
<b>13125R/L</b>	●		125	112.3	80	63	38.1	15.9	10	38	16	4	16	3.3	2
<b>13160R/L</b>	●		160	147.3	120	63	50.8	19	11	38	20	5	20	6.4	2
<b>13200R/L</b>			200	187.3	150	63	47.625	25.4	14	35	28	7	28	7.8	3
<b>13250R/L</b>			250	237.3	200	63	47.625	25.4	14	35	36	9	36	12.6	3
<b>13315R/L</b>			315	302.3	240	80	47.625	25.4	14	35	44	11	44	20.2	4

### Body (GFXC 13000 Coarse Pitch)

Dimensions (mm)

Cat. No.	Stock		Max. Dia.	Dia.	Boss	Height	Bore Dia.	Keyway Width	Keyway Depth	Mounting Depth	Total No. of Teeth	No. of Finishing Teeth	Effective No. of Teeth	Weight (kg)	Fig
	R	L	DCX	DC	DCSFMS	LF	DCB	KWW	KDP	CBDP					
<b>GFXC13063RS/LS</b>	●		63	50.3	50	50	22	10.4	6	20	4	1	4	0.9	1
<b>GFXC13080R/L</b>	●		*80	67.3	60	50	25.4	9.5	6	25	6	1	6	1.4	1
<b>13100R/L</b>	●		100	87.3	70	50	31.75	12.7	8	32	8	2	8	1.9	2
<b>13125R/L</b>	●		125	112.3	80	63	38.1	15.9	10	38	10	2	10	3.3	2
<b>13160R/L</b>	●		160	147.3	120	63	50.8	19	11	38	12	3	12	6.4	2
<b>13200R/L</b>	●		200	187.3	150	63	47.625	25.4	14	35	16	4	16	7.8	3
<b>13250R/L</b>	●		250	237.3	184	63	47.625	25.4	14	35	20	5	20	9.4	3
<b>13315R/L</b>	●		315	302.3	240	80	47.625	25.4	14	35	24	6	24	17.9	4

\*1 GFXC13063RS/LS is  $\phi 11$ . (Fig 1)

\*2 GFXC13063RS/LS is  $\phi 18$ . (Fig 1)

Application Examples

Inserts are sold separately.

For securing the  $\phi 80$  mm cutters marked with \* to the arbor, use a JIS B1176 hexagonal socket bolt (M12 x 30 to 35 mm).

### Insert

Dimensions (mm)

Grade	Coated Carbide			Carbide	CBN	Cat. No.	Nose Radius RE	Fig
	High-speed Finishing	Finishing/Medium Cutting	Roughing	H10E	BN7000			
		<b>K</b>	<b>K</b>		<b>K</b>	LNGX 130508PNFN-W	0.8	1
		<b>K</b>	<b>K</b>			130516PNFN-W	1.6	1
						130516PNTN-W	1.6	2

Parts

● Permissible Spindle Speed for CBN Inserts by Size

### Precautions for Use of GFXC Type

GFXC Type can be used with fewer teeth attached. In this case, only mount inserts to the mounting positions with markings. Remove the screws from the mounting positions where inserts will not be mounted.

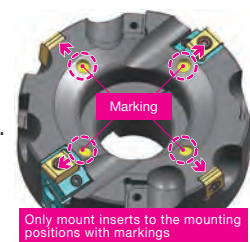

No. of GFXC type inserts for all teeth mounted versus mounted number of teeth reduced.

Cat. No.	Diameter DC	Total No. of Teeth	Mounted No. of Teeth Reduced	Cat. No.	Diameter DC	Total No. of Teeth	Mounted No. of Teeth Reduced
GFXC 13063RS/LS	63mm	4	2	GFXC 13160R/L	160mm	12	6
13080R/L	80mm	6	2	13200R/L	200mm	16	8
13100R/L	100mm	8	4	13250R/L	250mm	20	10
13125R/L	125mm	10	4	13315R/L	315mm	24	12

The number of inserts mounted should always match either the "Total No. of Teeth" or "Mounted No. of Teeth Reduced" quantities.

### Recommended Cutting Conditions

Work Material	Hardness	Cutting Speed $v_c$ (m/min)	Feed Rate $f_z$ (mm/t)	Insert Grade
		Min. - Optimum - Max.	Min. - Optimum - Max.	
<b>K</b> Cast Iron	250HB	200- 250- 350	0.1-0.3-0.5	ACK260
<b>K</b> Cast Iron	250HB	800- 1,000- 1,200	0.1-0.3-0.5	BN7000

Note Calculate cutting conditions based on effective no. of teeth.

● mark: Standard stocked item ● mark: Standard stocked item (expanded item) Blank: Made-to-order item — mark: Not available

Rake	Radial	-8°	1 mm	89 to 89 30'
Angle	Axial	-5°		

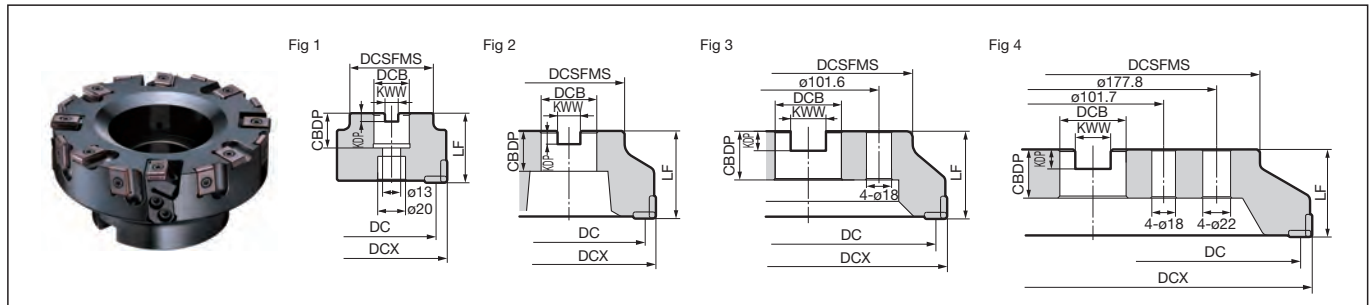

## Body (GFX 16000 Type)

Dimensions (mm)

Cat. No.	Stock		Max. Dia. DCX	Dia. DC	Boss DCSFMS	Height LF	Bore Dia. DCB	Keyway Width KWW	Keyway Depth KDP	Mounting Depth CDDP	Total No. of Teeth	No. of Finishing Teeth	Effective No. of Teeth	Weight (kg)	Fig
	R	L													
<b>GFX 16080R/L</b>			*80	64.1	60	50	25.4	9.5	6	25	8	2	8	1.4	1
<b>16100R/L</b>	●		100	84.1	70	50	31.75	12.7	8	32	12	3	12	1.9	2
<b>16125R/L</b>	●		125	109.1	80	63	38.1	15.9	10	38	16	4	16	3.3	2
<b>16160R/L</b>	●		160	144.1	120	63	50.8	19	11	38	20	5	20	6.4	2
<b>16200R/L</b>	●		200	184.1	150	63	47.625	25.4	14	35	28	7	28	7.8	3
<b>16250R/L</b>			250	234.1	200	63	47.625	25.4	14	35	36	9	36	12.6	3
<b>16315R/L</b>			315	299.1	240	80	47.625	25.4	14	35	44	11	44	20.2	4

Inserts are sold separately.

Application Examples **P9,10**

For securing the ø80 mm cutters marked with \* to the arbor, use a JIS B1176 hexagonal socket bolt (M12 x 30 to 35 mm).

## Insert

Dimensions (mm)

Grade		Coated Carbide	Carbide	CBN	Fig		
Process	High-speed Finishing			<b>K</b>			
	Finishing/Medium Cutting	<b>K</b>					
	Roughing	<b>K</b>	<b>K</b>				
Cat. No.		ACK260	ACK280	ACK300	H10E	BN7000	
<b>LNGX 160516PNFN-W</b>		●	●		●	—	1
<b>160516PNTN-W</b>		—	—	—	—	—	2

## Parts

Cartridges (For 13000)(For 16000)		Adjustment Screw	Wrench	Insert Screw	Wrench (For Adjustment Screw)	Cap Screw/Radial Cartridge (For GFXK4R/L)(For GFVK5R/L)		Wrench (For Cartridges)	Anti-seizure Cream
GFXK4R/L	GFVK5R/L	BTD05F09	TTX15W	BFTX03588	3.0	LT15	BX0414 BX0418	TH030	SUMI-P

Finishing cartridges do not come assembled with inserts.

## Permissible Spindle Speed for CBN Inserts by Cutter Size

Max. Dia. (mm) DCX	Allowable Spindle Speed (min) n max.	Max. Dia. (mm) DCX	Allowable Spindle Speed (min) n max.
ø63	6,000	ø160	2,300
ø80	4,700	ø200	1,900
ø100	3,800	ø250	1,500
ø125	3,000	ø315	1,200

## Recommended Cutting Conditions

Work Material	Hardness	Cutting Speed $v_c$ (m/min) Min. - Optimum - Max.	Feed Rate $f_z$ (mm/t) Min. - Optimum - Max.	Insert Grade
<b>K</b> Cast Iron	250HB	200- 250- 350	0.1-0.3-0.5	ACK260
<b>K</b> Cast Iron	250HB	800- 1,000- 1,200	0.1-0.3-0.5	BN7000

**Note** Calculate cutting conditions based on effective no. of teeth.

Rake	Radial	-11°	10mm	90°
Angle	Axial	-3°		

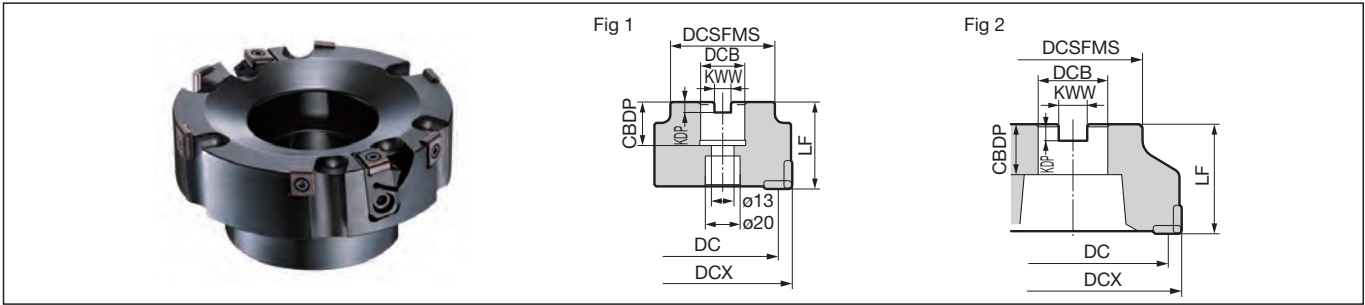

## Body

Dimensions (mm)

Inch	Cat. No.	Stock		Max. Dia. DCX	Dia. DC	Boss DCSFMS	Height LF	Bore Dia. DCB	Keyway Width KWW	Keyway Depth KDP	Mounting Depth CDBP	Total No. of Teeth	No. of Finishing Teeth	Effective No. of Teeth	Weight (kg)	Fig
		R	L													
	<b>GFS13080R/L</b>			*80	66.9	60	50	25.4	9.5	6	25	5	1	4	1.4	1
	<b>13100R/L</b>			100	86.9	70	50	31.75	12.7	8	32	6	1	5	1.9	2
	<b>13125R/L</b>			125	111.9	80	63	38.1	15.9	10	38	8	2	6	3.3	2
	<b>13160R/L</b>			160	147.3	120	63	50.8	19	11	38	10	2	8	6.4	2

Inserts are sold separately.

Application Examples P10

For securing the ø80 mm cutters marked with \* to the arbor, use a JIS B1176 hexagonal socket bolt (M12 x 30 to 35 mm).

## Insert

Dimensions (mm)

Grade	Coated Carbide		Carbide			
High-speed/Light	<b>K</b>			<b>K</b>		
General-purpose	<b>K</b>					
Roughing		<b>K</b>	<b>K</b>			
Cat. No.	ACK260	ACK280	ACK300	H10E	Nose Radius RE	Fig
LNGX 130508PNFN-W	●	●		●	0.8	1
130516PNFN-W	●	●		●	1.6	1

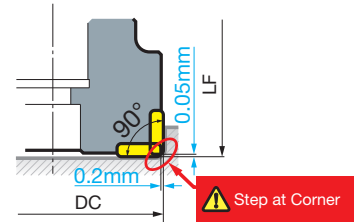
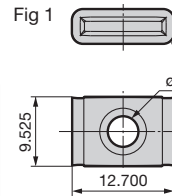

## Parts

Finishing Cartridges	Adjustment Screw	Wrench	Insert Seat Screw	Wrench (For Adjustment)	Cap Screw (For Cartridges)	Wrench (For Cartridges)	Anti-seizure Cream	
GFSK4R/L	BTD05F09	TTX15W	BFTX03588	3.0	LT15	BX0520	TH040	SUMI-P

Finishing cartridges do not come assembled with inserts.

## Recommended Cutting Conditions

Work Material	Hardness	Cutting Speed $v_c$ (m/min)	Feed Rate $f_z$ (mm/t)	Insert Grade
		Min. - Optimum - Max.	Min. - Optimum - Max.	
<b>K</b> Cast Iron	250HB	200-250-300	0.10-0.15-0.30	ACK260

Note Calculate cutting conditions based on effective no. of teeth.

Rake Angle	Radial	-6°30' to -5°	
	Axial	-6°	

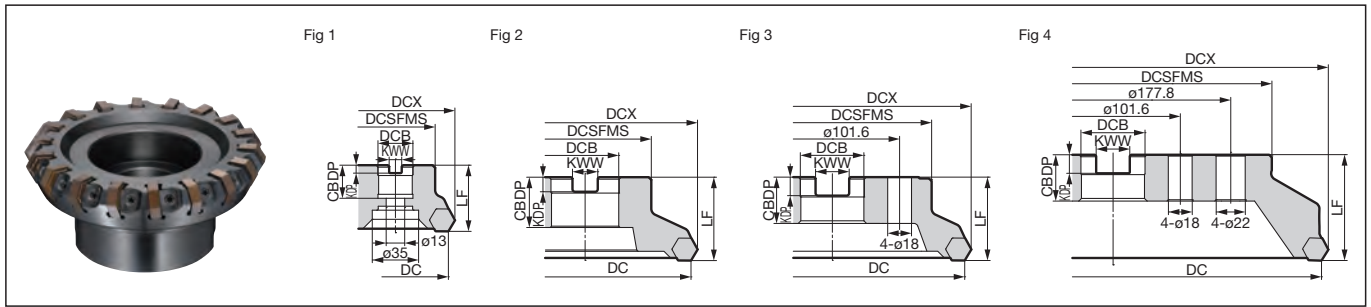

### Body

Dimensions (mm)

Cat. No.	Stock		Dia. DC	Max. Dia. DCX	Boss DCSFMS	Height LF	Bore Dia. DCB	Keyway Width KWW	Keyway Depth KDP	Mounting Depth CBDP	Total No. of Teeth	Weight (kg)	Fig
	R	L											
GRHNM 17080R/L	●		*80	90.5	60	50	25.4	9.5	6	25	8	1.2	1
17100R/L	●		100	110.5	70	50	31.75	12.7	8	32	10	1.7	2
17125R/L	●		125	135.5	80	63	38.1	15.9	10	38	12	2.9	2
17160R/L	●		160	170.5	100	63	50.8	19.1	11	38	16	4.5	2
17200R/L	●		200	210.5	150	63	47.625	25.4	14	35	20	7.3	3
17250R/L	●		250	260.5	200	63	47.625	25.4	14	35	24	13.1	3
17315R/L	●		315	325.5	240	80	47.625	25.4	14	35	28	24.5	4

Inserts are sold separately.

Application Examples

For securing the ø80 mm cutters marked with \* to the arbor, use a JIS B1176 hexagonal socket bolt (M12 x 30 to 35 mm).

### Insert

Dimensions (mm)

Grade		Coated Carbide			Fig
Process	High-speed/Light	K	K		
	General-purpose	K	K		
	Roughing			K	
Cat. No.		ACK100	ACK200	ACK300	Fig
HNEF 100608DNEN-G		●	●	●	1

### Parts

Double Screw	Clamp	Wrench
WB6-20T	6.0 GRHNM	TTX20

### Recommended Cutting Conditions

Work Material	Hardness	Cutting Speed $v_c$ (m/min) Min. - Optimum - Max.	Feed Rate $f_z$ (mm/t) Min. - Optimum - Max.	Insert Grade
<b>K</b> Cast Iron	250HB	200-250-300	0.15-0.23-0.30	ACK200

**Note** Calculate cutting conditions based on effective no. of teeth.

Rake	Radial	-6°30' to -5°	
Angle	Axial	-6°	

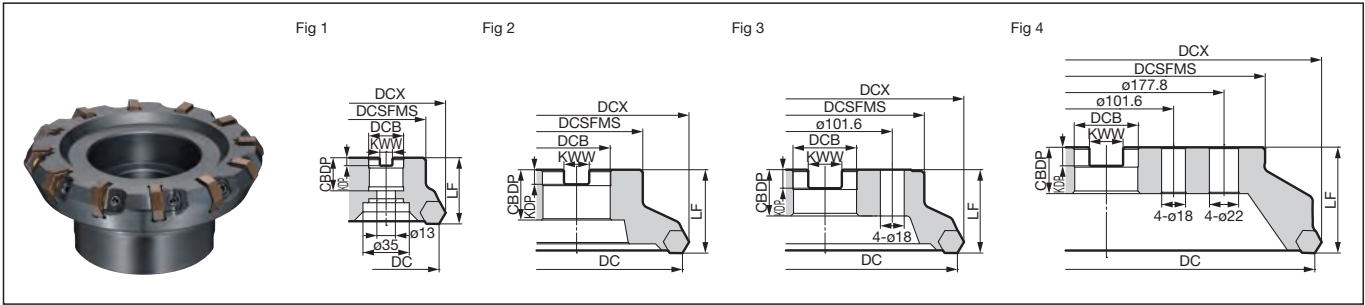

## Body

Dimensions (mm)

Inch	Cat. No.	Stock		Dia. DC	Max. Dia. DCX	Boss DCSFMS	Height LF	Bore Dia. DCB	Keyway Width KWW	Keyway Depth KDP	Mounting Depth CBDP	Total No. of Teeth	Weight (kg)	Fig
		R	L											
	GRHNF 17080R/L	●		*80	90.5	60	50	25.4	9.5	6	25	10	1.2	1
	17100R/L	●		100	110.5	70	50	31.75	12.7	8	32	14	1.8	2
	17125R/L	●		125	135.5	80	63	38.1	15.9	10	38	18	2.9	2
	17160R/L	●		160	170.5	100	63	50.8	19.1	11	38	22	4.5	2
	17200R/L	●		200	210.5	150	63	47.625	25.4	14	35	28	7.3	3
	17250R/L	●		250	260.5	200	63	47.625	25.4	14	35	36	13.1	3
	17315R/L	●		315	325.5	240	80	47.625	25.4	14	35	44	24.5	4

Inserts are sold separately.

For securing the ø80 mm cutters marked with \* to the arbor, use a JIS B1176 hexagonal socket bolt (M12 x 30 to 35 mm).

## Insert

Dimensions (mm)

Grade		Coated Carbide			Fig
Process	High-speed/Light	K	K		
	General-purpose	K	K		
	Roughing			K	
Cat. No.		ACK100	ACK200	ACK300	Fig
HNEF 100608DNEN-G		●	●	●	1

## Parts

Double Screw	Clamp	Wrench
WB6-20T	6.0 GRHNW	TTX20

## Recommended Cutting Conditions

Work Material	Hardness	Cutting Speed $v_c$ (m/min)		Feed Rate $f_z$ (mm/t)		Insert Grade
		Min. - Optimum - Max.	Min. - Optimum - Max.	Min. - Optimum - Max.	Min. - Optimum - Max.	
<b>K</b> Cast Iron	250HB	200-250-300		0.15-0.23-0.30		ACK200

**Note** Calculate cutting conditions based on effective no. of teeth.



## Application Examples

Application: Finishing

● Workpiece: Side Face of Cylinder Block		GFXC Type	Comp's
Work Material: <b>FC250</b> Roughness Standard: Rz 12.5µm Machine: Horizontal Machining Centre 	Tool	<b>GFXC13100R</b>	ø100
	Grade	<b>BN7000</b>	CVD
	Insert Mounting	Tangential Screw Locked	Wedge Type
	Number of Teeth	4	10
	$V_c$ (m/min)	1,200	251
	$V_f$ (mm/min)	10,000	500
	$f_z$ (mm/t)	0.65	0.063
	$a_p$ (mm)	0.5	0.5
	Coolant	Dry	Dry
	Results	<ul style="list-style-type: none"> <li>· <math>v_f=10,000</math> mm/min can be realised</li> <li>· Achieves a <math>v_f</math> value 20 times larger than our competitors' products</li> </ul>	

Application: Finishing

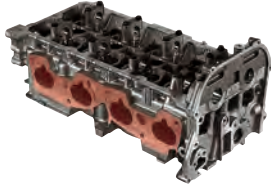
● Workpiece: Side Face of Cylinder Head		GFXC Type	Comp's
Work Material: <b>FC250</b> Roughness Standard: Rz 12.5µm Machine: Horizontal Machining Centre 	Tool	<b>GFXC13125R</b>	ø125
	Grade	<b>BN7000</b>	PVD
	Insert Mounting	Tangential Screw Locked	Horizontal Screw Locked
	Number of Teeth	4	12
	$V_c$ (m/min)	1,000	216
	$V_f$ (mm/min)	6,000	376
	$f_z$ (mm/t)	0.59	0.057
	$a_p$ (mm)	0.5	1.0
	Coolant	Dry	Dry
	Results	<ul style="list-style-type: none"> <li>· <math>v_f=6,000</math> mm/min can be realised</li> <li>· Improves efficiency by 16 times and provides better surface roughness than our competitors' products.</li> </ul>	

Application: Finishing

● Workpiece: Bottom Face of Cylinder Block		GFXC Type	Conv.
Work Material: <b>FC250</b> Roughness Standard: Ra 6.3µm Machine: Horizontal Machining Centre 	Tool	<b>GFXC13125R</b>	ø125
	Grade	<b>ACK260</b>	CBN
	Insert Mounting	Tangential Screw Locked	Wedge Type
	Number of Teeth	10	4
	$V_c$ (m/min)	250	510
	$V_f$ (mm/min)	1,020	1,020
	$f_z$ (mm/t)	0.16	0.20
	$a_p$ (mm)	0.5	0.5
	Coolant	Remainder Wet	Remainder Wet
	Results	<ul style="list-style-type: none"> <li>· Carbide tools providing a tool life as long as CBN cutters.</li> <li>· Reduces costs.</li> </ul>	

Application: Finishing

● Workpiece: Bottom Face of Cylinder Block		GFX Type	Comp's					
Work Material: <b>FC250</b> Roughness Standard: Ra 3.2µm Machined: Special Machine 	Tool	<b>GFX16315R (Special Type)</b>	ø315					
	Grade	<b>ACK260</b>	PVD					
	Insert Mounting	Tangential Screw Locked	Wedge Type					
	Number of Teeth	44 (Effective)	40					
	$V_c$ (m/min)	148	148					
	$V_f$ (mm/min)	720	720					
	$f_z$ (mm/t)	0.11	0.12					
	$a_p$ (mm)	0.5	0.5					
	Coolant	Dry	Dry					
	Results	<table border="1"> <tr> <td>Tool</td> <td>Workpieces/Corner</td> </tr> <tr> <td>GFX Type</td> <td>1,500 - 2,500 - 3,500</td> </tr> <tr> <td>Comp's</td> <td>2,300 Units</td> </tr> </table>	Tool	Workpieces/Corner	GFX Type	1,500 - 2,500 - 3,500	Comp's	2,300 Units
Tool	Workpieces/Corner							
GFX Type	1,500 - 2,500 - 3,500							
Comp's	2,300 Units							
Evaluation	Provides a tool life approximately 1.5 times longer than that of our competitors' products.							

Application: Finishing

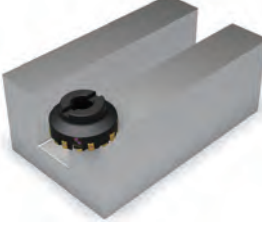
● Workpiece: Lathe Bed		GFX Type	Comp's
Work Material: <b>FC250</b> Roughness Standard: Ra 6.3µm Machine: Double Column Machining Centre 	Tool	<b>GFX16125R</b>	ø125
	Grade	<b>ACK260</b>	Ceramic
	Insert Mounting	Tangential Screw Locked	-
	Number of Teeth	16	10
	$V_c$ (m/min)	300	785
	$V_f$ (mm/min)	3,057	3,000
	$f_z$ (mm/t)	0.25	0.15
	$a_p$ (mm)	0.3	0.3
	Coolant	Dry	Dry
	Results	Equivalent $v_f$ value to ceramics achieved with carbide	
Evaluation	Reduced running costs		

Application: Roughing

● Workpiece: Printer Roller		GRHNM Type	Comp's
Work Material: <b>FCD450</b> Machine: Horizontal Machining Centre 	Tool	<b>GRHNM17080R</b>	ø80
	Grade	<b>ACK200</b>	PVD
	Insert Mounting	Screw Locked	Screw Locked
	Number of Teeth	8	9
	$V_c$ (m/min)	230	151
	$V_f$ (mm/min)	732.5	541
	$f_z$ (mm/t)	0.1	0.1
	$a_p$ (mm)	3 to 5	3 to 5
	Coolant	Dry	Dry
	Results	· Achieves 1.4 Times Machining Efficiency	

Application: Roughing

● Workpiece: Machine Tool Parts		GRHNM Type	Comp's
Work Material: <b>FC300</b> Machine: Double Column Machining Centre 	Tool	<b>GRHNM17160R</b>	ø160
	Grade	<b>ACK200</b>	CVD
	Insert Mounting	Screw Locked	Wedge Type
	Number of Teeth	16	8
	$V_c$ (m/min)	250	140
	$V_f$ (mm/min)	1,780	549
	$f_z$ (mm/t)	0.20	0.245
	$a_p$ (mm)	3→5→2	3→5→2
	Coolant	Dry	Dry
	Results	· Achieves 3.2 Times Machining Efficiency	

## Application Examples

Application: Finishing

● Workpiece: Housing		GFXC Type	Comp's
Work Material: <b>FC250</b> Roughness Standard: Ra 1.6µm Machine: Horizontal Machining Centre	Tool	<b>GFXC13100R</b>	ø100
	Grade	<b>ACK260</b>	CVD
	Insert Mounting	Tangential Screw Locked	Horizontal Screw Locked
	Number of Teeth	8	10
	V <sub>c</sub> (m/min)	250	250
	V <sub>f</sub> (mm/min)	960	530
	f <sub>z</sub> (mm/t)	0.15	0.066
	a <sub>p</sub> (mm)	0.1	0.1
	Coolant	Dry	Dry
	Results	· Provides higher efficiency and accuracy and is visually better than our competitors' products. · Achieves a tool life that is over 2.5 times longer than that of our competitors' products.	



Application: Finishing

● Workpiece: Large Diesel Engine (Base Plate)		GFX Type	Current Tool
Work Material: <b>FC250-FC300</b> Roughness Standard: Ra 3.2µm Size: 1,600mm x 1,800mm Machine: Horizontal Machining Centre	Tool	<b>GFX16160R</b>	ø160
	Grade	<b>ACK260</b>	CBN
	Insert Mounting	Tangential Screw Locked	Blade Type
	Number of Teeth	20	10
	V <sub>c</sub> (m/min)	300	980
	V <sub>f</sub> (mm/min)	2,980	1,950
	f <sub>z</sub> (mm/t)	0.25	0.10
	a <sub>p</sub> (mm)	0.3	0.3
	Coolant	Dry	Dry
	Results	Carbide tools achieve 1.5 times the efficiency of CBN and provide machined surfaces equivalent to those machined with CBN on visual inspection.	

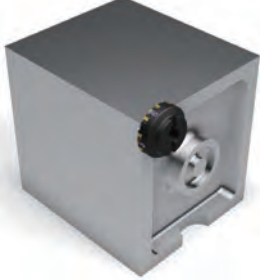

Application: Finishing

● Workpiece: Side of Lathe Bed (11m Overall Length)		GFX Type	Comp's					
Work Material: <b>FC300</b> Roughness Standard: Ra 3.2µm Machine: Double Column Machining Centre	Tool	<b>GFX16160R</b>	ø160					
	Grade	<b>ACK260</b>	CVD					
	Insert Mounting	Tangential Screw Locked	Horizontal Screw Locked					
	Number of Teeth	20	8					
	V <sub>c</sub> (m/min)	120	125					
	V <sub>f</sub> (mm/min)	477	400					
	f <sub>z</sub> (mm/t)	0.10	0.20					
	a <sub>p</sub> (mm)	0.3	0.3					
	Coolant	Dry	Dry					
	Results	<table border="1"> <tr> <th>Tool</th> <th>Cutting Length/Corner</th> </tr> <tr> <td>GFX Type</td> <td>40m</td> </tr> <tr> <td>Comp's</td> <td>10m</td> </tr> </table>		Tool	Cutting Length/Corner	GFX Type	40m	Comp's
Tool	Cutting Length/Corner							
GFX Type	40m							
Comp's	10m							
Evaluation	Provides a cutting length 4 times longer than that of our competitors' products.							



Application: Finishing

● Workpiece: Angle Plate		GFS Type
Work Material: <b>FC300</b> Roughness Standard: Ra 3.2µm Machine: Horizontal Machining Centre	Tool	<b>GFS13125R</b>
	Grade	<b>ACK260</b>
	Insert Mounting	Tangential Screw Locked
	Number of Teeth	6
	V <sub>c</sub> (m/min)	137
	V <sub>f</sub> (mm/min)	1,000
	f <sub>z</sub> (mm/t)	0.47
	a <sub>p</sub> (mm)	0.015
	Coolant	Dry
	Results	Surface Roughness: Ra 1.0 µm No Step Final Grinding Omitted



Application: Finishing

● Workpiece: Hydraulic Component		GFX Type	Comp's					
Work Material: <b>FCD450</b> Roughness Standard: Ra 3.2µm Machine: Horizontal Machining Centre	Tool	<b>GFX13080R</b>	ø80					
	Grade	<b>ACK260</b>	PVD					
	Insert Mounting	Tangential Screw Locked	Vertical Drawing Pins					
	Number of Teeth	8	6					
	V <sub>c</sub> (m/min)	218	180					
	V <sub>f</sub> (mm/min)	1,600	650					
	f <sub>z</sub> (mm/t)	0.23	0.15					
	a <sub>p</sub> (mm)	0.1	0.1					
	Coolant	Wet	Wet					
	Results	<table border="1"> <tr> <th>Tool</th> <th>Workpieces/Corner</th> </tr> <tr> <td>GFX Type</td> <td>148 Units</td> </tr> <tr> <td>Comp's</td> <td>100 Units</td> </tr> </table>		Tool	Workpieces/Corner	GFX Type	148 Units	Comp's
Tool	Workpieces/Corner							
GFX Type	148 Units							
Comp's	100 Units							
Evaluation	Provides a tool life approximately 1.5 times longer than that of our competitors' products.							



Application: Finishing

● Workpiece: Rear Hub Carrier		GFX Type	Current Tool
Work Material: <b>FCD450</b> Roughness Standard: Rz 25µm Machine: Horizontal Machining Centre	Tool	<b>GFX16100R</b>	ø100
	Grade	<b>ACK260</b>	CVD
	Insert Mounting	Tangential Screw Locked	Wedge Type
	Number of Teeth	12	14
	V <sub>c</sub> (m/min)	250	150
	V <sub>f</sub> (mm/min)	3,150	800
	f <sub>z</sub> (mm/t)	0.33	0.12
	a <sub>p</sub> (mm)	0.5-1.0	0.5-1.0
	Coolant	Wet	Wet
	Results	· Current tools cause steps in machined surfaces. · Efficiency improved.	



Application: Finishing

● Workpiece: Hydraulic Component		GFX Type	Conv.					
Work Material: <b>FCD600</b> Roughness Standard: Ra 1.6µm Machine: Horizontal Machining Centre	Tool	<b>GFX16125R (Special Type)</b>	ø125					
	Grade	<b>ACK260</b>	PVD					
	Insert Mounting	Tangential Screw Locked	Wedge Type					
	Number of Teeth	6	6					
	V <sub>c</sub> (m/min)	160	150					
	V <sub>f</sub> (mm/min)	733	110					
	f <sub>z</sub> (mm/t)	0.30/1.20	0.05					
	a <sub>p</sub> (mm)	0.25	0.25					
	Coolant	Wet	Wet					
	Results	<table border="1"> <tr> <th>Tool</th> <th>Tool Life/Corner</th> </tr> <tr> <td>GFX Type</td> <td>350min</td> </tr> <tr> <td>Conv.</td> <td>150min</td> </tr> </table>		Tool	Tool Life/Corner	GFX Type	350min	Conv.
Tool	Tool Life/Corner							
GFX Type	350min							
Conv.	150min							
Evaluation	Provides tool life approximately 2.3 times longer than conventional tools							

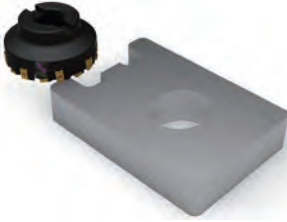

Application: Simultaneous Finishing

● Workpiece: Crank Case		GFX Type	Comp's					
Work Material: <b>Al + FC250</b> Roughness Standard: Ra 3.2µm Machine: Vertical Machining Centre	Tool	<b>GFX13100R</b>	ø100					
	Grade	<b>ACK260</b>	PVD					
	Insert Mounting	Tangential Screw Locked	Vertical Drawing Pins					
	Number of Teeth	12	12					
	V <sub>c</sub> (m/min)	400	314					
	V <sub>f</sub> (mm/min)	1,529	1,440					
	f <sub>z</sub> (mm/t)	0.10	0.12					
	a <sub>p</sub> (mm)	0.3	0.3					
	Coolant	Wet	Wet					
	Results	<table border="1"> <tr> <th>Tool</th> <th>Workpieces/Corner</th> </tr> <tr> <td>GFX Type</td> <td>250 Units</td> </tr> <tr> <td>Comp's</td> <td>100 Units</td> </tr> </table>		Tool	Workpieces/Corner	GFX Type	250 Units	Comp's
Tool	Workpieces/Corner							
GFX Type	250 Units							
Comp's	100 Units							
Evaluation	Tool life approximately 2.5 times that of competitors' products							



# MEMO

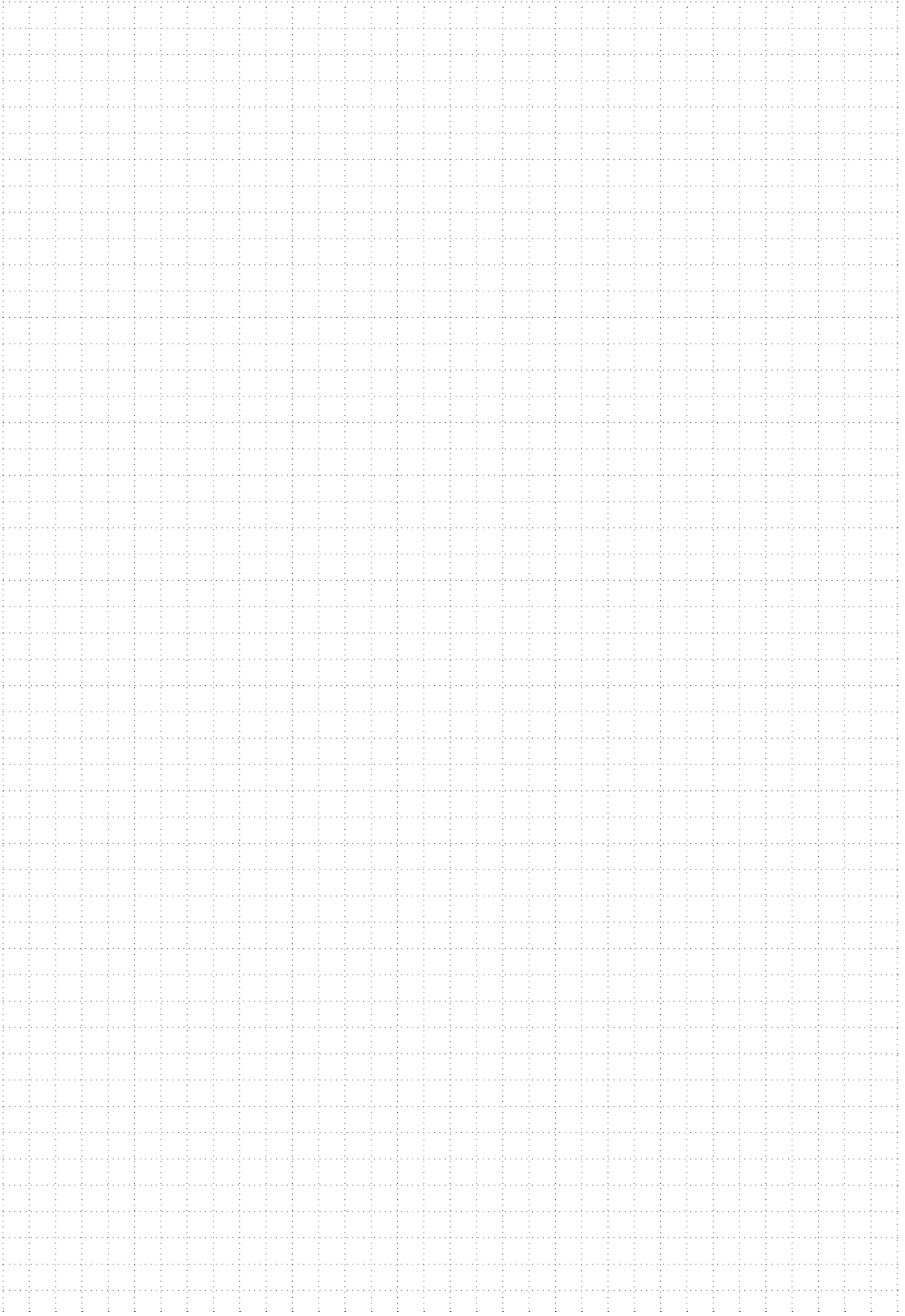



- Very hot or lengthy chips may be discharged while the machine is in operation. Therefore, machine guards, safety goggles or other protective covers must be used. Fire safety precautions must also be considered.

#### < SAFETY NOTES >

- Please handle with care as this product has sharp edges.
- Improper cutting conditions or mis-handling of the tool may result in breakages or projectiles. Therefore, please use the tool within its recommended conditions.

- When using non-water soluble cutting oil, precautions against fire must be taken and please ensure that a fire extinguisher is placed near the machine.

 **Sumitomo Electric Industries, Ltd.**

**Hardmetal Division**

Global Marketing Department : 1-1-1, Koyakita, Itami, Hyogo 664-0016, Japan

Tel: +81-72-772-4535 Fax: +81-72-771-0088

<https://www.sumitool.com/global>