

SEC-Grooving Tool Holders **GND** series

Rev. 17

Stable Machining Through
Outstanding Chip Control and
Chatter Resistance



High precision machining with a cutting width tolerance of $\pm 0.03\text{mm}$
(width of cut 1.25 to 6mm / lead angle 0° , 5°)

Available in 10 chipbreaker styles and 11 insert grades for diverse machining applications

New Series now includes Holders for Deep Grooves GNDXL type, for groove depths up to 32mm

New Introducing 90° Inserts for Special Grooving (Made-to-order items)

New



For groove depths up to 32mm
**GNDXL type + Dedicated
1-cornered Insert**

New



SEC-Grooving Tools GND series

High Rigidity Body

The SEC-Grooving Tools GND series uses a mono-block structure die steel body to achieve excellent grooving, as well as suppression of chatter for stable machining in turning / profiling / facing work.

Diverse Chipbreakers

The SEC-Grooving Tools GND series lineup includes 10 chipbreaker styles suited to various machining applications. Stable chip evacuation is possible in a variety of processes

VIDEO OF CUTTING



Grooving / Traverse Cutting	Grooving / Cut-off			Cut-off	Profiling	Profiling / Necking	Non-Ferrous Metals
General-purpose	Low Feed	General-purpose	Low Feed	Low Cutting Force	General-purpose	Low Cutting Force	General-purpose

SEC-Grooving Tool Holders GND series Cutting Performance

Reduced chattering

High-rigidity design reduces chattering by up to 30% as compared to conventional tools.

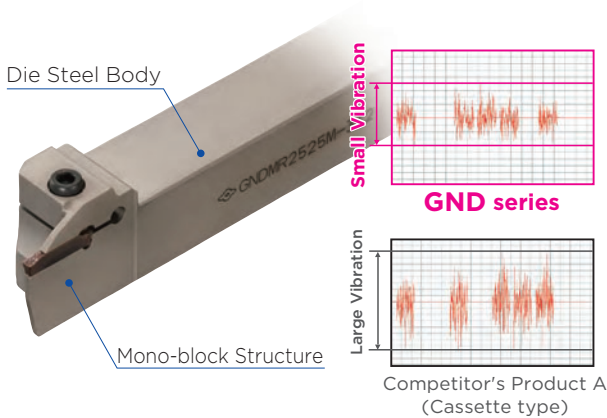

Work Material: SCM415
Holder: GNDL R2525M-220 Insert: GCM N2002-GG
Cutting Conditions: $vc=100\text{m/min}$ $f=0.10\text{mm/rev}$ $ap=20.0\text{mm}$ Wet

Both high rigidity and good chip evacuation performance

Internal Grooving

Wide pocket improves chip evacuation performance

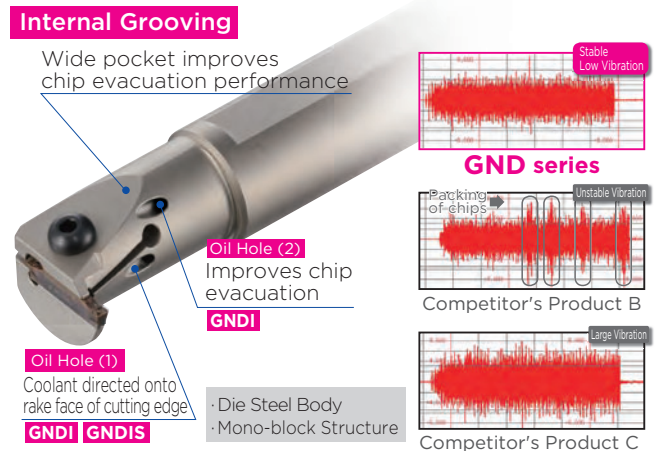

Work Material: SCM415
Holder: GNDI R2532-T306 Insert: GCM N3002-GG
Cutting Conditions: $vc=100\text{m/min}$ $f=0.05\text{mm/rev}$ $ap=3.0\text{mm}$ Wet

Cutting Performance

Substantially improved machining efficiency

High-rigidity holder enables turning at high feed rates

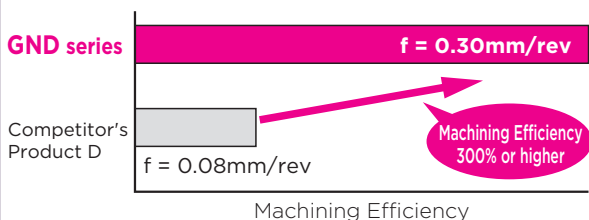

Work Material: SCM435
Holder: GNDL R2525M-320 Insert: GCM N3002-GG(AC530U)
Cutting Conditions: $vc=130\text{m/min}$ $f=0.30\text{mm/rev}$ Wet

Long, stable tool life ensures reliable functionality even on automatic production lines!

Reduction of chattering prevents unexpected breakage

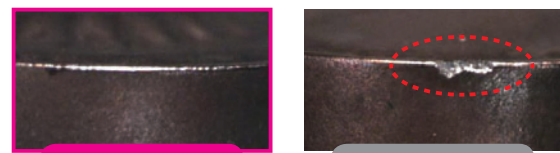

Normal wear
GND series

Fracture
Competitor's Product E

Work Material: S53C
Holder: GNDM L2525M-618 Insert: GCM N6030-RG(AC530U)
Cutting Conditions: $vc=130\text{m/min}$ $f=0.3\text{mm/rev}$ Wet

■ New Holders for Deep Grooves GNDXL type *New* 

- SEC-Grooving Tools GND series now feature holders for deep grooves with groove depth up to **32mm**
- Integrated high-rigidity body and insert realise superb vibration resistance with extra-strong clamp-on specifications
- Shank width lineup includes **20mm square** and **25mm square**
- Dedicated **1-cornered inserts** for deep grooving with **widths of cut from 3.0 to 6.0mm** are stocked (2.0mm is a made-to-order item)
- Chipbreaker lineup includes ML type / GF type / RN type

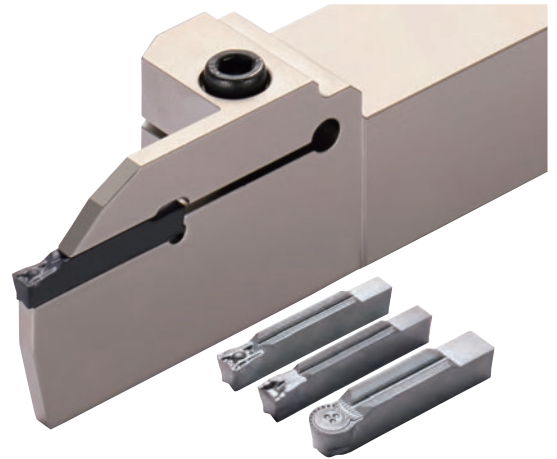

● Vibration Resistance

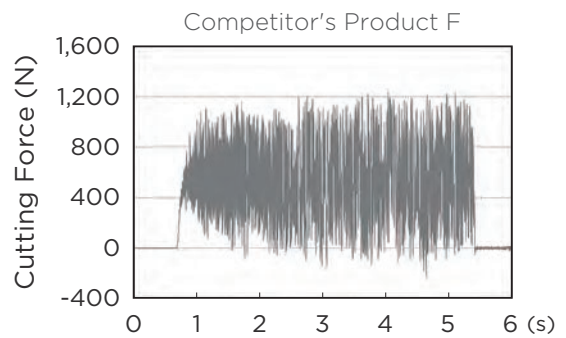
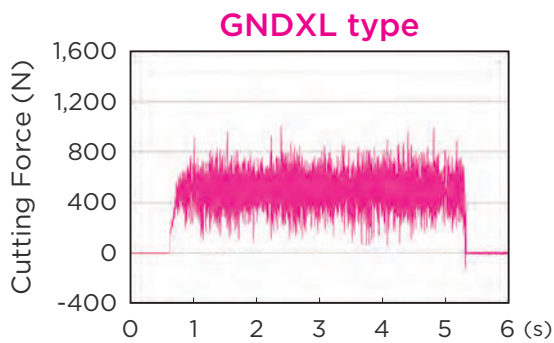

Work Material: SUS316 Holder: GNDXL R2525M-332 Insert: GCMN3002-GF1 (AC530U) Cutting Conditions: vc=100m/min f=0.10mm/rev ap=10mm Wet (External Coolant Supply)

■ 90° Insert for Special Grooving (Made-to-order item) *New*

- Ideal for grooving in narrow spaces
- Widths of cut from 2.0 to 5.0mm available as made-to-order items
- Various cutting edge designs possible with ground type inserts
- Utilises an unique insert fallout prevention design

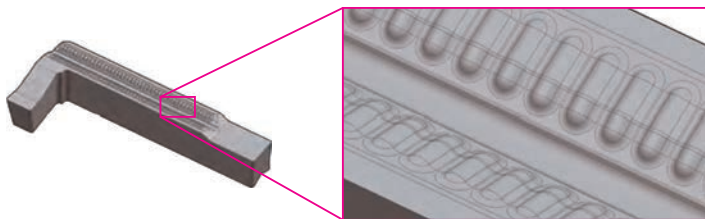

Grip effect for extra-strong clamping



GND series 90° Insert Request Form 

Usage Example: Aerospace Engine Disc

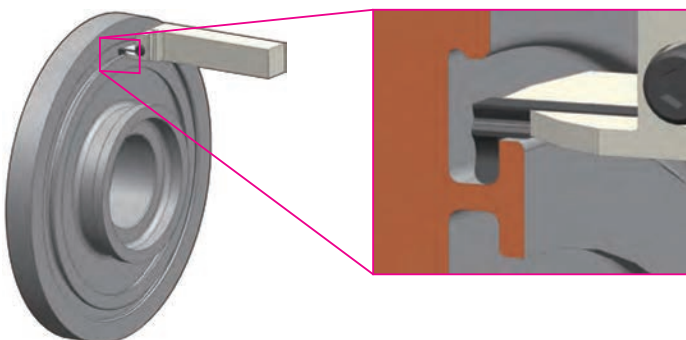

■ Achieving stability and longer tool life ... A variety of chipbreakers ensure outstanding chip evacuation performance in many different types of applications.

Grooving / Traverse Cutting			Grooving / Cut-off			Cut-off		Profiling		Profiling Necking		Non-Ferrous Metals	
General-purpose	Low Feed	General-purpose	Low Feed	Low Cutting Force	General-purpose	Low Cutting Force	General-purpose	General-purpose	General-purpose	General-purpose	General-purpose	General-purpose	General-purpose
MG type	ML type	GG type	GL type	GF type	CG type	CF type	RG type	RN type	GA type				
Standard chipbreaker for traverse cutting	For low-feed chip control	1st recommendation for grooving	For low-feed chip control	For low cutting force and chip control at low-feeds	1st recommendation for cut-off machining	For low-feed chip control	For external profiling and radius grooving	For facing, internal profiling, radius grooving and necking	Ideal for aluminum alloy machining				
Cutting Edge Cross Section	Cutting Edge Cross Section	Cutting Edge Cross Section	Cutting Edge Cross Section	Cutting Edge Cross Section	Cutting Edge Cross Section	Cutting Edge Cross Section	Cutting Edge Cross Section	Cutting Edge Cross Section	Cutting Edge Cross Section	Cutting Edge Cross Section	Cutting Edge Cross Section	Cutting Edge Cross Section	Cutting Edge Cross Section
Edge Widths in Stock (mm)	Edge Widths in Stock (mm)	Edge Widths in Stock (mm)	Edge Widths in Stock (mm)	Edge Widths in Stock (mm)	Edge Widths in Stock (mm)	Edge Widths in Stock (mm)	Edge Widths in Stock (mm)	Edge Widths in Stock (mm)	Edge Widths in Stock (mm)	Edge Widths in Stock (mm)	Edge Widths in Stock (mm)	Edge Widths in Stock (mm)	Edge Widths in Stock (mm)
1.25 1.5 2.0	1.25 1.5 2.0	1.25 1.5 2.0	1.25 1.5 2.0	1.25 1.5 2.0	1.25 1.5 2.0	1.25 1.5 2.0	1.25 1.5 2.0	1.25 1.5 2.0	1.25 1.5 2.0	1.25 1.5 2.0	1.25 1.5 2.0	1.25 1.5 2.0	1.25 1.5 2.0
3.0 4.0 5.0	3.0 4.0 5.0	3.0 4.0 5.0	3.0 4.0 5.0	3.0 4.0 5.0	3.0 4.0 5.0	3.0 4.0 5.0	3.0 4.0 5.0	3.0 4.0 5.0	3.0 4.0 5.0	3.0 4.0 5.0	3.0 4.0 5.0	3.0 4.0 5.0	3.0 4.0 5.0
6.0 7.0 8.0	6.0 7.0 8.0	6.0 7.0 8.0	6.0 7.0 8.0	6.0 7.0 8.0	6.0 7.0 8.0	6.0 7.0 8.0	6.0 7.0 8.0	6.0 7.0 8.0	6.0 7.0 8.0	6.0 7.0 8.0	6.0 7.0 8.0	6.0 7.0 8.0	6.0 7.0 8.0
Stocked Grades	Stocked Grades	Stocked Grades	Stocked Grades	Stocked Grades	Stocked Grades	Stocked Grades	Stocked Grades	Stocked Grades	Stocked Grades	Stocked Grades	Stocked Grades	Stocked Grades	Stocked Grades
AC8025P AC8035P AC8025P AC8035P	AC8025P AC8035P AC8025P AC8035P	AC8025P AC8035P AC8025P AC8035P	AC8025P AC8035P AC8025P AC8035P	AC8025P AC8035P AC8025P AC8035P	AC8025P AC8035P AC8025P AC8035P	AC8025P AC8035P AC8025P AC8035P	AC8025P AC8035P AC8025P AC8035P	AC8025P AC8035P AC8025P AC8035P	AC8025P AC8035P AC8025P AC8035P	AC8025P AC8035P AC8025P AC8035P	AC8025P AC8035P AC8025P AC8035P	AC8025P AC8035P AC8025P AC8035P	AC8025P AC8035P AC8025P AC8035P
AC830P AC425K AC830P AC425K	AC830P AC425K AC830P AC425K	AC830P AC425K AC830P AC425K	AC830P AC425K AC830P AC425K	AC830P AC425K AC830P AC425K	AC830P AC425K AC830P AC425K	AC830P AC425K AC830P AC425K	AC830P AC425K AC830P AC425K	AC830P AC425K AC830P AC425K	AC830P AC425K AC830P AC425K	AC830P AC425K AC830P AC425K	AC830P AC425K AC830P AC425K	AC830P AC425K AC830P AC425K	AC830P AC425K AC830P AC425K
AC5015S AC5025S AC5015S AC5025S	AC5015S AC5025S AC5015S AC5025S	AC5015S AC5025S AC5015S AC5025S	AC5015S AC5025S AC5015S AC5025S	AC5015S AC5025S AC5015S AC5025S	AC5015S AC5025S AC5015S AC5025S	AC5015S AC5025S AC5015S AC5025S	AC5015S AC5025S AC5015S AC5025S	AC5015S AC5025S AC5015S AC5025S	AC5015S AC5025S AC5015S AC5025S	AC5015S AC5025S AC5015S AC5025S	AC5015S AC5025S AC5015S AC5025S	AC5015S AC5025S AC5015S AC5025S	AC5015S AC5025S AC5015S AC5025S
AC520U AC530U AC520U AC530U	AC520U AC530U AC520U AC530U	AC520U AC530U AC520U AC530U	AC520U AC530U AC520U AC530U	AC520U AC530U AC520U AC530U	AC520U AC530U AC520U AC530U	AC520U AC530U AC520U AC530U	AC520U AC530U AC520U AC530U	AC520U AC530U AC520U AC530U	AC520U AC530U AC520U AC530U	AC520U AC530U AC520U AC530U	AC520U AC530U AC520U AC530U	AC520U AC530U AC520U AC530U	AC520U AC530U AC520U AC530U
AC1030U T2500A AC1030U T2500A	AC1030U T2500A AC1030U T2500A	AC1030U T2500A AC1030U T2500A	AC1030U T2500A AC1030U T2500A	AC1030U T2500A AC1030U T2500A	AC1030U T2500A AC1030U T2500A	AC1030U T2500A AC1030U T2500A	AC1030U T2500A AC1030U T2500A	AC1030U T2500A AC1030U T2500A	AC1030U T2500A AC1030U T2500A	AC1030U T2500A AC1030U T2500A	AC1030U T2500A AC1030U T2500A	AC1030U T2500A AC1030U T2500A	AC1030U T2500A AC1030U T2500A
H10	H10	H10	H10	H10	H10	H10	H10	H10	H10	H10	H10	H10	H10
*: GNDIS type Only				*: GNDIS type Only				Lead Angle: 5°		Lead Angle: 10°/15°			

■ Improved Chip Control

Grooving



GNDseries
(GG type Chipbreaker)

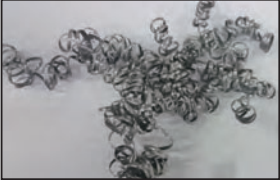

Conventional Tool

Work Material: SCM415
 Holder: GNDL R2525M-320 Insert: GCM N3002-GG
 Cutting Conditions: vc=100m/min f=0.15mm/rev ap=12.0mm Wet

Traverse cutting



GND series
(ML type Chipbreaker)



Conventional Tool

Work Material: SCM415
 Holder: GNDM R2525M-312 Insert: GCM N3002-ML
 Cutting Conditions: vc=100m/min f=0.10mm/rev ap=0.5mm Wet

Cut-off



GND series
(CG type Chipbreaker)



Competitor's Product

Work Material: SUS316(φ30mm)
 Holder: GNDL R2525M-220 Insert: GCM R2002-CG-05
 Cutting Conditions: vc=100m/min f=0.15mm/rev Wet

Profiling

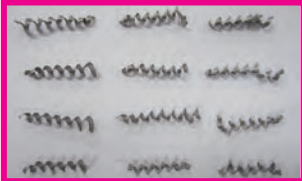

GND series
(RG type Chipbreaker)



Conventional Tool

Work Material: SCM415
 Holder: GNDM R2525M-312 Insert: GCM N3015-RG
 Cutting Conditions: vc=100m/min f=0.15mm/rev ap=0.1mm Wet

■ Chipbreaker Selection

	Grooving / Traverse Cutting	Grooving	Cut-off	
1st Recommendation	<p>MG type General-purpose</p> 	<p>GG type General-purpose</p> 	<p>GG type General-purpose</p> 	
2nd Recommendation	<p>ML type Low Feed Chip Control Emphasised Cutting Edge Width: Up to 4.0mm Cutting Edge Width: 5.0mm and greater</p> 	<p>GL type General-purpose Chip Control Emphasised</p> 	<p>CG type General-purpose Feed Direction Lead Angle 5°</p> 	
	<p>GF type Low Cutting Force</p> 	<p>CF type Low Cutting Force Feed Direction Lead Angle 10° / 15°</p> 	<p>GF type Low Cutting Force</p> 	
	External Profiling / External Radius Grooving	Facing / Internal Profiling / Radius Grooving / Necking	Non-Ferrous Metals	
Recommendation	<p>RG type General-purpose 1st Recommendation</p> 	<p>RN type General-purpose 2nd Recommendation 2mm Width Supported</p> 	<p>RN type General-purpose</p> 	<p>GA type General-purpose Non-Ferrous Metals</p> 

■ Insert Grade Selection

Application	P Steel	M Stainless Steel	K Cast Iron	S Exotic Alloy	N Non-Ferrous Metals
Continuous / High-speed ↑ ↓ Interrupted / Unstable	<p>AC8025P CVD Surface Finish Emphasised</p>	<p>AC8035P (AC830P) CVD</p>	<p>AC425K CVD 1st Recommendation</p>	<p>AC5015S PVD</p>	
	<p>AC8035P (AC830P) CVD</p>	<p>AC5015S PVD</p>	<p>AC8025P CVD</p>	<p>AC5025S (AC520U) PVD 1st Recommendation</p>	<p>H10 1st Recommendation</p>
	<p>AC5025S (AC520U) PVD</p>	<p>AC5025S (AC520U) PVD 1st Recommendation</p>	<p>AC5015S PVD</p>	<p>AC5025S (AC520U) PVD</p>	
	<p>AC530U / AC1030U PVD 1st Recommendation</p>	<p>AC530U / AC1030U PVD</p>	<p>AC5025S (AC520U) PVD</p>	<p>AC530U / AC1030U PVD</p>	<p>Uncoated Carbide</p>

Only AC520U and AC1030U inserts are stocked for GNDIS type holders.

 For External Machining (For Small Lathes)



Traverse Cutting / Profiling (Cut-off)

Grooving / Cut-off (Traverse Cutting)

GNDM type
Straight type



Shank Size (H x W)
16 x 16mm
20 x 12mm

P18 SumiSmall

Available Edge Widths (mm)		
1.25	1.5	2.0
3.0	4.0	5.0
6.0	7.0	8.0

Applicable Chipbreaker
MG ML GG GL GF CG CF RG RN GA

GNDM-J type
Straight type



Shank Size (H x W)
16 x 16mm
20 x 12mm

P20 SumiSmall

Available Edge Widths (mm)		
1.25	1.5	2.0
3.0	4.0	5.0
6.0	7.0	8.0

Applicable Chipbreaker
MG ML GG GL GF CG CF RG RN GA

GNDL type
Straight type



Shank Size (H x W)
10 x 10mm
12 x 12mm
16 x 16mm
20 x 12mm

P18 SumiSmall

Available Edge Widths (mm)		
1.25	1.5	2.0
3.0	4.0	5.0
6.0	7.0	8.0

Applicable Chipbreaker
MG ML GG GL GF CG CF RG RN GA

GNDL-J type
Straight type



Shank Size (H x W)
12 x 12mm
16 x 16mm
20 x 12mm

P20 SumiSmall

Available Edge Widths (mm)		
1.25	1.5	2.0
3.0	4.0	5.0
6.0	7.0	8.0



Applicable Chipbreaker
MG ML GG GL GF CG CF RG RN GA

**For External Machining
 For Small Lathes series**

MG: Multi-Functional / General-purpose type **ML**: Multi-Functional / Low-feed type **GG**: Grooving / General-purpose type **GL**: Grooving / Low-feed type **GF**: Grooving / Low cutting force type
CG: Cut-off / General-purpose type **CF**: Cut-off / Low cutting force type **RG**: Profiling / General-purpose type **RN**: Facing / Necking / General-purpose type **GA**: Non-Ferrous Metal / General-purpose type

Type	Shank Size (mm) Height (H) / Width (B)	Width of Cut (mm)								Series	Max. Groove Depth (mm)						Ref. Page	Applicable Chipbreakers																
		1.25	1.5	2	3	4	5	6	7		8	5	10	15	20	25		30	MG	ML	GG	GL	GF	CG	CF	RG	RN	GA						
For Small Lathes	10	10	1.25	1.5							GNDL	10						P18																
			2											10						P18														
			3											10						P18														
	12	12	1.25	1.5								GNDL	12						P18															
			2										GNDL	12.5						P18														
			2									GNDL-J		12.5						P20														
			3										GNDL	12.5						P18														
			3									GNDL-J		12.5						P20														
			16	16	1.25										GNDM	8						P18												
	1.25	1.5										GNDL	12.5						P18															
	1.5												GNDM	10						P18														
	2											GNDM		12						P18														
2											GNDM-J		12						P20															
2												GNDL	16						P18															
2											GNDL-J		16						P20															
3												GNDM	12						P18															
3											GNDM-J		12						P20															
3												GNDL	16						P18															
3											GNDL-J		16						P20															
20	12	2												GNDM	17						P18													
		2								GNDM-J	17						P20																	
		2										GNDL	21						P18															
		2									GNDL-J		21						P20															
		3										GNDM	17						P18															
		3									GNDM-J		17						P20															
		3										GNDL	21						P18															
		3									GNDL-J		21						P20															
		3										GNDL	21						P18															
3									GNDL-J	21						P20																		

 In Stock

 Best  Suitable

 For External Machining (L type)

Traverse Cutting / Profiling (Cut-off)

Grooving / Cut-off (Traverse Cutting)

GNDMS type
 L type



Shank Size (H x W)
 20 x 20mm
 25 x 25mm

P24

Available Edge Widths (mm)		
1.25	1.5	2.0
3.0	4.0	5.0
6.0	7.0	8.0

Applicable Chipbreaker
 MG ML GG GL GF CG CF RG RN GA

GNDLS type
 L type



Shank Size (H x W)
 20 x 20mm
 25 x 25mm

P28

Available Edge Widths (mm)		
1.25	1.5	2.0
3.0	4.0	5.0
6.0	7.0	8.0

Applicable Chipbreaker
 MG ML GG GL GF CG CF RG RN GA

For External Machining L type series

MG: Multi-Functional / General-purpose type
 ML: Multi-Functional / Low-feed type
 GG: Grooving / General-purpose type
 GL: Grooving / Low-feed type
 GF: Grooving / Low cutting force type
CG: Cut-off / General-purpose type
 CF: Cut-off / Low cutting force type
 RG: Profiling / General-purpose type
 RN: Facing / Necking / General-purpose type
 GA: Non-Ferrous Metal / General-purpose type

Type	Shank Size (mm) Height (H) / Width (B)	Width of Cut (mm)							Series	Max. Groove Depth (mm)						Ref. Page	Applicable Chipbreakers																
		1.25	1.5	2	3	4	5	6		7	8	5	10	15	20		25	30	MG	ML	GG	GL	GF	CG	CF	RG	RN	GA					
L type	20	20			2						GNDLS	16						P28															
					3							GNDMS	10						P24														
				3								GNDLS	16						P28														
						4						GNDMS	12						P24														
							5					GNDMS	12						P24														
								5				GNDLS	18						P28														
	25	25			2						GNDLS	12						P24															
					3							GNDMS	18						P28														
						3						GNDLS	18						P28														
							4					GNDMS	14						P24														
								4				GNDLS	23						P28														
									5	6		GNDMS	14						P24														
									5	6	GNDLS	23						P28															

 : In Stock

⊙: Best ○: Suitable

 For External Machining (SumiPolygon Cassette)

Grooving / Cut-off / Traverse Cutting / Profiling

GNDCM type
 Cassette



Applicable Holder
 SumiPolygon
 GND00 (Straight)
 GND90 (L-Shape)

P44

Available Edge Widths (mm)		
1.25	1.5	2.0
3.0	4.0	5.0
6.0	7.0	8.0

Applicable Chipbreaker
 MG ML GG GL GF CG CF RG RN GA

SumiPolygon Cassette series

MG: Multi-Functional / General-purpose type
 ML: Multi-Functional / Low-feed type
 GG: Grooving / General-purpose type
 GL: Grooving / Low-feed type
 GF: Grooving / Low cutting force type
CG: Cut-off / General-purpose type
 CF: Cut-off / Low cutting force type
 RG: Profiling / General-purpose type
 RN: Facing / Necking / General-purpose type
 GA: Non-Ferrous Metal / General-purpose type

Type	Applicable SumiPolygon Holders	Width of Cut (mm)							Series	Max. Groove Depth (mm)						Ref. Page	Applicable Chipbreakers														
		1.25	1.5	2	3	4	5	6		7	8	5	10	15	20		25	30	MG	ML	GG	GL	GF	CG	CF	RG	RN	GA			
Cassette	GND00 (Straight)			2						GNDCM	12						P44														
				3							12						P44														
	GND90 (L-Shape)					4					18						P44														
								5	6			18						P44													

 : In Stock

⊙: Best ○: Suitable

Guides
 External Dia.
 Face
 Internal Dia.
 Necking
 SumiPolygon
 Request Form
 Application Examples

For Internal Machining (Work Dia.: $\phi 14\text{mm}$ -)
 Grooving / Traverse Cutting / Profiling



Inserts are dedicated products.

For Internal Machining (Work Dia.: $\phi 32\text{mm}$ -)
 Grooving / Traverse Cutting / Profiling



Series for Internal Machining
 (Machining Dia. $\phi 14\text{mm}$ -)

ML: Multi-functional / Low-feed type GF: Grooving / Low cutting force type

Type	Shank Size DCON (mm)	Width of Cut (mm)			Series	Max. Groove Depth (mm)					Min. Bore Dia. (mm)	Ref. Page	Applicable Chipbreakers (Dedicated for GNDIS type)	
		1.5	2	3		5	10	15	20	25			30	ML
Straight type	$\phi 12$	1.5			GNDIS	2.6					$\phi 14$	P40		⊙
		1.5				3.6					$\phi 14$	P40		⊙
			2	3		2.6					$\phi 14$	P40	⊙	⊙
			2	3		3.6					$\phi 14$	P40	⊙	⊙
	$\phi 16$	1.5			GNDIS	3.6					$\phi 16$	P40		⊙
		1.5				4.6					$\phi 20$	P40		⊙
		2	3	3.6					$\phi 16$	P40	⊙	⊙		
		2	3	4.6					$\phi 20$	P40	⊙	⊙		
$\phi 20$	1.5			GNDIS	6.6					$\phi 25$	P40		⊙	
					6.6					$\phi 25$	P40	⊙	⊙	

 : In Stock

Note: Only dedicated GXM inserts can be used for GNDIS types.

⊙: Best

Series for Internal Machining
 (Machining Dia. $\phi 32\text{mm}$ -)

MG: Multi-functional / General-purpose type ML: Multi-functional / Low-feed type GG: Grooving / General-purpose type GL: Grooving / Low-feed type GF: Grooving / Low cutting force type
 CG: Cut-off / General-purpose type CF: Cut-off / Low cutting force type RG: Profiling / General-purpose type RN: Facing / Necking / General-purpose type GA: Non-Ferrous Metal / General-purpose type

Type	Shank Size DCON (mm)	Width of Cut (mm)					Series	Max. Groove Depth (mm)					Min. Bore Dia. (mm)	Ref. Page	Applicable Chipbreakers									
		2	3	4	5	6		5	10	15	20	25			30	MG	ML	GG	GL	GF	CG	CF	RG	RN
Straight type	$\phi 25$	2					GNDI	6					$\phi 32$	P42	⊙	⊙	⊙	⊙					⊙	⊙
			3	4	5	6		6						$\phi 32$	P42	⊙	⊙	⊙	⊙					⊙
Straight type	$\phi 32$	2					GNDI	6					$\phi 32$	P42	⊙	⊙	⊙	⊙					⊙	⊙
			3	4	5	6		10						$\phi 40$	P42	⊙	⊙	⊙	⊙					⊙
Straight type	$\phi 40$	3	4	5	6		GNDI	11					$\phi 50$	P42	⊙	⊙	⊙	⊙					⊙	⊙

 : In Stock

⊙: Best ○: Suitable

Width of Cut (mm)	Recommended Cutting Conditions		Corner Radius (mm)	Applicable Insert
	Grooving / Cut-off (Necking)	Traverse Cutting		
1.25	Chipbreaker 	—	0.05	MG ML GG GL GF CG CF RG RN GA
1.5	Chipbreaker 	—	0.05	MG ML GG GL GF CG CF RG RN GA
2.0	Chipbreaker 	Depth of Cut ap (mm) 	0.03	MG ML GG GL GF CG CF RG RN GA
			0.2	MG ML GG GL GF CG CF RG RN GA
			0.4	MG ML GG GL GF CG CF RG RN GA
			1.0	MG ML GG GL GF CG CF RG RN GA
3.0	Chipbreaker 	Depth of Cut ap (mm) 	0.03	MG ML GG GL GF CG CF RG RN GA
			0.2	MG ML GG GL GF CG CF RG RN GA
			0.4	MG ML GG GL GF CG CF RG RN GA
			1.5	MG ML GG GL GF CG CF RG RN GA
4.0	Chipbreaker 	Depth of Cut ap (mm) 	0.2	MG ML GG GL GF CG CF RG RN GA
			0.4	MG ML GG GL GF CG CF RG RN GA
			0.8	MG ML GG GL GF CG CF RG RN GA
			2.0	MG ML GG GL GF CG CF RG RN GA
5.0	Chipbreaker 	Depth of Cut ap (mm) 	0.2	MG ML GG GL GF CG CF RG RN GA
			0.4	MG ML GG GL GF CG CF RG RN GA
			0.8	MG ML GG GL GF CG CF RG RN GA
			2.5	MG ML GG GL GF CG CF RG RN GA
6.0	Chipbreaker 	Depth of Cut ap (mm) 	0.2	MG ML GG GL GF CG CF RG RN GA
			0.4	MG ML GG GL GF CG CF RG RN GA
			0.8	MG ML GG GL GF CG CF RG RN GA
			3.0	MG ML GG GL GF CG CF RG RN GA
7.0	Chipbreaker 	Depth of Cut ap (mm) 	0.2	MG ML GG GL GF CG CF RG RN GA
			0.4	MG ML GG GL GF CG CF RG RN GA
			0.8	MG ML GG GL GF CG CF RG RN GA
			3.5	MG ML GG GL GF CG CF RG RN GA
8.0	Chipbreaker 	Depth of Cut ap (mm) 	0.2	MG ML GG GL GF CG CF RG RN GA
			0.4	MG ML GG GL GF CG CF RG RN GA
			0.8	MG ML GG GL GF CG CF RG RN GA
			4.0	MG ML GG GL GF CG CF RG RN GA

For face grooving, use cutting conditions closer to the lower limit of the recommended cutting conditions to ensure that chips are long. In cut-off applications, reduce the feed rate to around 30% to 50% near the centre of the workpiece. As there is less space for chip evacuation when machining internal diameters (particularly small bore diameters), ML/GL/GF type chipbreakers are recommended. Modifications to inserts and holders are required to perform turning such as radius grooving when using the RG type chipbreaker with the GNDF type holder for facing. Use GNDXL type holders at feed rate 80% or below.

Recommended Cutting Conditions

Recommended Cutting Conditions for GNDIS type P41

Work Material	P Carbon Steel / Alloy Steel					M Stainless Steel			K Cast Iron			S Exotic Alloy		N Non-Ferrous Metals	
Insert Grade	AC8025P	AC8035P AC830P	AC5015S AC520U	AC5025S AC530U AC1030U	T2500A	AC8035P AC830P	AC5015S AC520U	AC5025S AC530U AC1030U	AC8025P	AC425K	AC5015S AC520U	AC5025S AC530U AC1030U	AC5015S AC520U	AC5025S AC530U AC1030U	H10
Cutting Speed vc (m/min)	80 to 250	80 to 200	80 to 200	50 to 200	50 to 200	70 to 150	70 to 150	50 to 150	80 to 200	80 to 200	60 to 200	50 to 200	20 to 80	20 to 60	150 to 300

Guides
External Dia.
Face
Internal Dia.
Necking
SumiPolygon
Request Form
Application Examples

Key Points for Facing

Holder Selection

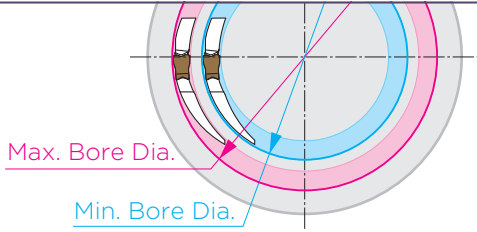

- Select a holder with which the outer diameter of the first groove to be machined is between the **maximum** and **minimum** grooving diameters of the holder.
- If the turning start point is within the effective work diameter range, the work diameter will not be limited for subsequent passes.
- Select the lower limit of the recommended cutting conditions for the chipbreaker and **ensure long chips for evacuation purposes**. (In face grooving, **broken chips easily get stuck in grooves**, which causes problems.)
- When breaking chips, step feed is required.

Precautions for Groove Expansion

Recommended Chipbreakers **MG ML GG GL GF GA**

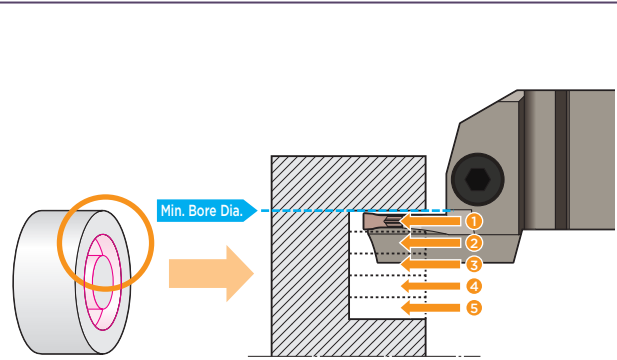

- If the first groove is within the effective work diameter range during groove expansion via plunging, the work diameter will not be limited for subsequent passes.

Precautions for Traverse Cutting

Recommended Chipbreakers **MG ML RN**

Considering the rigidity of the holder, we recommend turning from the outside to the inside.

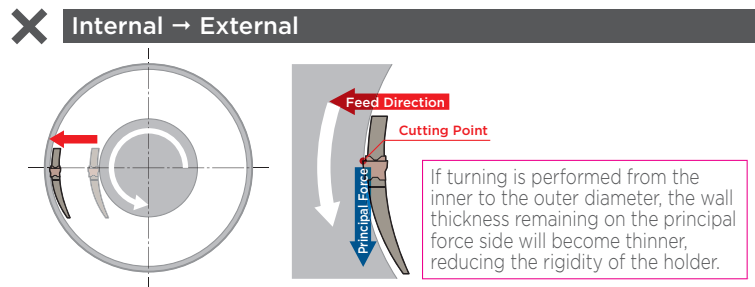
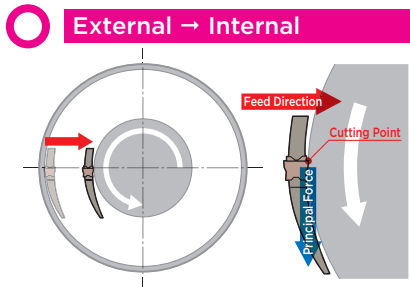

If turning is performed from the inner to the outer diameter, the wall thickness remaining on the principal force side will become thinner, reducing the rigidity of the holder.

- If the turning start point for traverse face cutting operation is within the effective work diameter range, the work diameter will not be limited for traverse cutting.

Key Points in Internal Machining

Precautions for Internal Machining

Recommended Chipbreakers **ML GL GF**

If the prepared hole diameter is small, use an **ML** type or **GL** type low-feed chipbreaker, both of which reduce chip curl diameter, to ensure adequate chip evacuation.

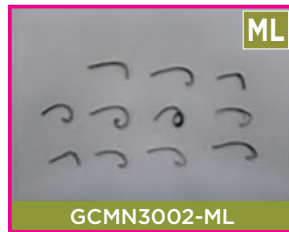

Work Material: SCM415 Prepared Hole Diameter: \varnothing 25mm Holder: GNDI R2532-T306 Insert: GCM N300O-OO
Cutting Conditions: $vc=100\text{m/min}$ $f=0.1\text{mm/rev}$ $ap=3.0\text{mm}$ Wet

Internal Machining



External Machining



Chip shapes differ between internal machining and external machining even under the same cutting conditions.

Work Material: SCM415
Holder: GNDL R2525M-320 Insert: GCM N3002-GG
Cutting Conditions: $vc=100\text{m/min}$ $f=0.10\text{mm/rev}$ $ap=5.0\text{mm}$ Wet

 **Key Points for Necking**

Precautions for Necking

Recommended Chipbreaker **RN**

Distance from Work Material to Necking Depth

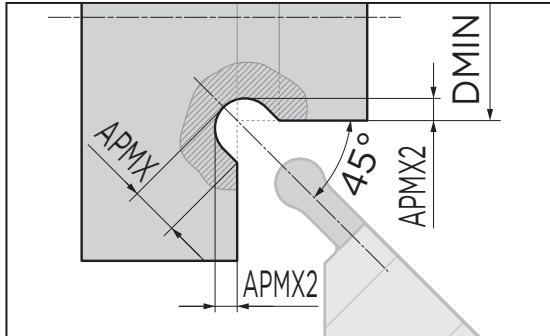

Width of Cut CW (mm)	Necking Depth APMX (mm)	Distance from Work Material to Necking Depth APMX2 (mm)
2.0	1.5	0.64
3.0	2.0	0.79
4.0	3.0	1.29
5.0	3.5	1.44
6.0	4.0	1.59

- For necking, these conditions are recommended for each width of cut when grooving with RN type chipbreakers.
- To prevent interference with the work material, the work diameter for each GNDN type holder should be set to the minimum bore diameter (DMIN) or less.

Chip Shape

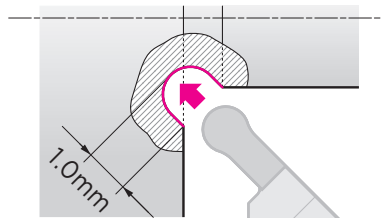
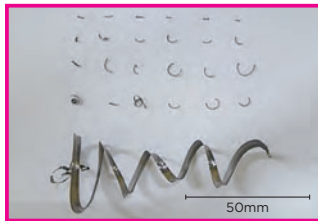

Work Material : SCM435 Groove Width: 3.0mm
 Holder : GNDN R2020K-320-020
 Insert : GCMN3015-RN
 Cutting Conditions : vc=100m/min f=0.1mm/rev
 Necking Depth =1.0mm Wet

Key Points in Internal Coolant Supply Holders For Small Lathes

- 12mm and 16mm square Internal Coolant Supply Holders for Small Lathes enable insert exchange from both top and bottom.

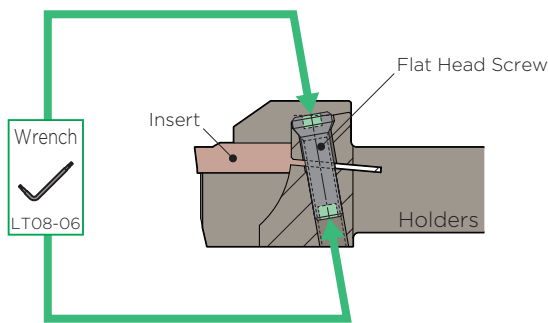

12mm square holder: **GNDL R/L1212JX-000.OJ**

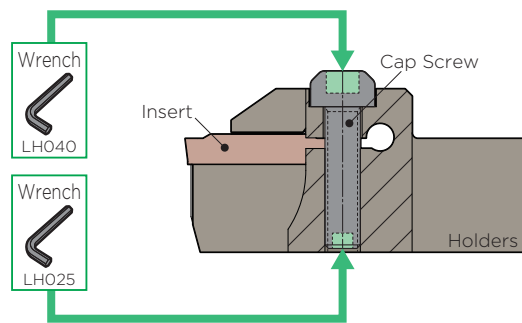

16mm square holder: **GNDM R/L1616JX-000J**
GNDL R/L1616JX-000J

Guides
 External Dia.
 Face
 Internal Dia.
 Necking
 SumiPolygon
 Request Form
 Application Examples

Precautions for SEC-Grooving Tool Holders GND series

■ Insert Mounting Precautions

- (1) Remove any dust, etc. from the insert seat, bolt, and bolt hole before attaching the insert.
- (2) If there are scratches or burrs on the insert seat, scrape them away.
- (3) Mount the insert by sliding it parallel to the seat.
- (4) Clamp the insert with the opposite side (holder side) of the cutting edge secured on the constraining surface.
- (5) **Tighten the insert with the recommended tightening torque.** If the insert is tightened with excessive torque, **it may be damaged, leading to injury.**
- (6) **When exchanging the insert, adjust the cutting edge offset value.**

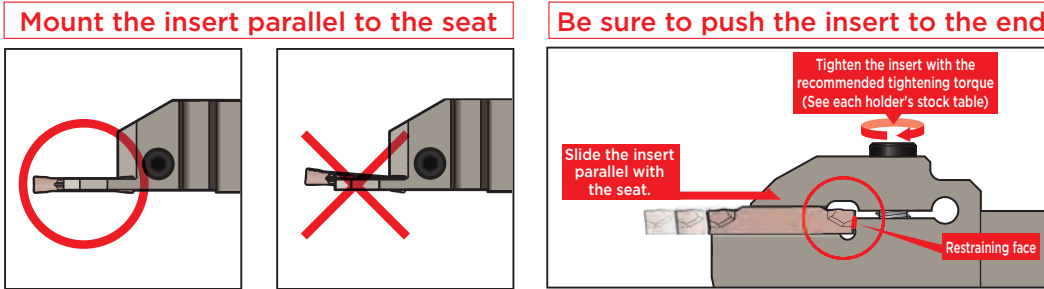

■ Precautions when Mounting Holders

- (1) Remove any dust and oil from the toolpost before setting the holder.
- (2) If there are scratches or burrs on the toolpost, scrape them away.
- (3) Place the holder so that the insert is perpendicular to the workpiece. Failure to do so may bend the machined surface or cause chattering.
- (4) The overhang of the holder should be as short as possible.
- (5) When grooving or traverse cutting, adjust the centre height of the cutting edge to as close to ± 0 mm as possible. (Within ± 0.1 mm is recommended.)
Incorrect centre height adjustment may cause chattering. In cut-off applications, adjust the centre height of the cutting edge to a value from 0 to $+0.2$ mm.
A lower centre height will result in a larger pip at the centre.
- (6) Set the oil supply nozzle so that coolant can be supplied from the top of the upper clamp unit.

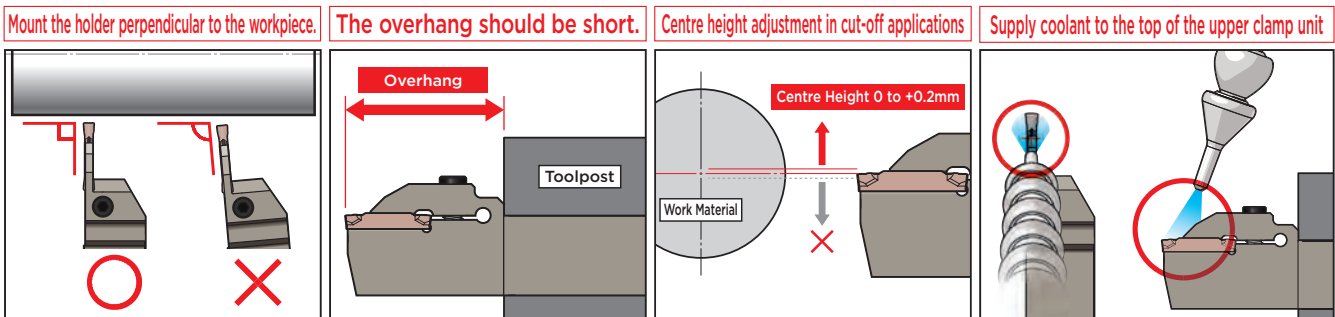

■ Depth of Cut when Pulling Out with RG/RN type Chipbreakers

Width of Cut (mm)	Maximum Depth of Cut when Pulling Out (mm)
CW	E1
2.0*	0.10
3.0	0.15
4.0	0.20
5.0	0.25
6.0	0.30
7.0	0.35
8.0	0.40

*: CW = 2.0 is RN type chipbreakers only

Precautions for SEC-Grooving Tool Holders GND series

■ Piping Method for Hoses and Connectors

Internal Coolant Holders
GNDM R/L0000□-000J
GNDL R/L0000□-000J

Connector (Straight)
J-G1/8-R1/8-00

Connector (L-Shaped)
J-G1/8-R1/8-90

Hose
J-HOSE-G1/8-G1/8-200 (Overall length 200mm)
J-HOSE-G1/8-G1/8-300 (Overall length 300mm)

Machine

- Apply sealant such as commercial sealing tape to the piping connection parts.
- For plug mounting when piping, see the figure below.

Piping from bottom (at shipping)
Plug XPO2
Piping from bottom

Piping from back end
Plug XPO2
Piping from back end

* The plug will protrude a few millimetres when mounted on the bottom.

■ Piping Method for Hoses and Connectors (For Small Lathes)

Internal Coolant Supply Holders for Small Lathes
GNDM R/L0000JX-000J
GNDL R/L0000JX-000J

Connector (Straight)
J-G1/8-R1/8-00

Connector (L-Shaped)
J-G1/8-R1/8-90

Hose
J-HOSE-G1/8-G1/8-200 (Overall length 200mm)
J-HOSE-G1/8-G1/8-300 (Overall length 300mm)

Machine (small lathes, etc.)

- Apply sealant such as commercial sealing tape to the piping connection parts.
- For plug mounting when piping, see the figure below.

Piping from side (at shipping)
Piping from side
Plug XPO2

Piping from back end
Plug XPO2
Piping from back end

Coolant Supply Without Hose Compatible Products
Plug XPO2
Plug XPO2
Connecting Point for Coolant Supply Without Hose

*1 : The plug will protrude a few millimetres when mounted on the side.
 *2 : The plug is mounted at shipping, so remove it for use with coolant supply without hose.

Coolant Supply to Holders Without Hose

Connecting Point for Coolant Supply Without Hose

For coolant supply without hose, remove the plug.

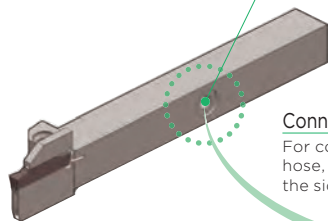

Connecting Points for Hoses
 For coolant supply without hose, mount plugs (XPO2) on the side and back end

Coolant Supply to Holders Without Hose

- 12mm size: **GNDL R/L1212JX-000J**
- 16mm size: **GNDM R/L1616JX-000J**
GNDL R/L1616JX-000J

Connecting point cross-section

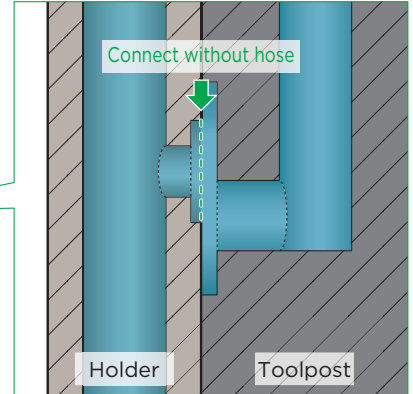

Compatible Toolpost for Coolant Supply Without Hose

■ Identification Code

Holders

GND M R 25 25 (M)-(T) 3 12 (J)-(-)(035)

(1) Series Code: GND
(2) Application: Refer to Table 2
(3) Feed Direction: Refer to Table 3
(4) Shank Height / Dia.: Refer to Table 4
(5) Shank Width / Work Dia.: Refer to Table 5
(6) Shank Length: Refer to Table 6
(7) Type: T: For Internal Boring
(8) Insert Cutting Edge Width: Refer to Table 8
(9) Maximum Groove Depth: Refer to Table 9
(10) Coolant Supply: J: Internal Coolant Supply
(11) Work Dia. / Min. Bore Dia. (mm)

Table 2 (2) Application

Symbol	Applications
S	For External Multi-Functional Machining: Traverse Cutting / Profiling (Grooving / Cut-off)
M	For External Multi-Functional Machining: Traverse Cutting / Profiling (Grooving / Cut-off)
L	For External Machining: Grooving / Cut-off (Traverse Cutting / Profiling)
XL	For External Deep Grooving: Grooving / Cut-off
MS	For External Multi-Functional Machining: L type Holder (Side Cut): Grooving / Traverse Cutting / Profiling
LS	For External Machining: L type Holder (Side Cut): Grooving
N	For Necking: Necking
F	For Face Machining: Grooving / Traverse Cutting / Profiling
FS	For Face Machining: L type: Grooving / Traverse Cutting / Profiling
I	For Internal Machining: Grooving / Traverse Cutting / Profiling
IS	For Internal Machining: Grooving / Traverse Cutting / Profiling
CM	SumiPolygon Cassette: Grooving / Cut-off / Traverse Cutting / Profiling

Table 3 (3) Feed Direction

Symbol	Feed Direction
R	Right-handed
L	Left-handed

Table 4 (4) Shank Height / Dia.

Applications	Height / Dia. (mm)
For External Turning / Facing (Shank Height)	10
	12
	16
	20
For Internal Machining (Shank Diameter)	25
	32
	40

Table 5 (5) Shank Width / Work Dia.

Applications	Width / Work Diameter (mm)
For External Turning / Facing (Shank Width)	10
	12
	16
	20
For Internal Machining (Min. Bore Diameter)	25
	32
	40

Table 6 (6) Shank Length

Symbol	Length (mm)
JX	120
K	125
M	150
P	170

Table 8 (8) Insert Cutting Edge Width *

Symbol	Width of Cut (mm)	Symbol	Width of Cut (mm)
1.25	1.25	5	5.0
1.5	1.5	6	6.0
2	2.0	7	7.0
3	3.0	8	8.0
4	4.0		

*Excluding GNDIS type.

Table 9 (9) Maximum Groove Depth *

Symbol	Depth (mm)	Symbol	Depth (mm)
06	6.0	14	14.0
08	8.0	16	16.0
10	10.0	18	18.0
11	11.0	20	20.0
12	12.0	23	23.0
12.5	12.5	25	25.0

*Excluding GNDN type / GNDIS type.

Refer to P44 for SumiPolygon Cassette.

Insert

G C M N 30 02 (S) - GG (1) (-)(05)

(1) Series Code: Grooving
(2) Front Relief Angle: Refer to Table 2
(3) Tolerance: Refer to Table 3
(4) Feed Direction: Refer to Table 4
(5) Insert Cutting Edge Width: Refer to Table 5
(6) Corner Radius: Refer to Table 6
(7) Applicable Holder: Refer to Table 7
(8) Chipbreaker: Refer to Table 8
(9) No. of Cutting Edges: Refer to Table 9
(10) Lead Angle: Refer to Table 10

Table 2 (2) Front Relief Angle

Symbol	Angle
C	7°
X	Others (Dedicated for GNDIS type)

Table 3 (3) Tolerance

Symbol	Insert Class
G	G Class
M	M Class

Table 4 (4) Feed Direction

Symbol	Feed Direction
R	Right-handed
L	Left-handed
N	Neutral

Table 5 (5) Insert Cutting Edge Width

Symbol	Width of Cut (mm)
125	1.25
150	1.5
20	2.0
30	3.0
40	4.0
50	5.0
60	6.0
70	7.0
80	8.0

Table 6 (6) Corner Radius

Symbol	RE (mm)
003	0.03
005	0.05
02	0.2
04	0.4
08	0.8
10	1.0
15	1.5
20	2.0
25	2.5
30	3.0

RE = 1.0mm or larger are for GA non-ferrous metals profiling.

Table 7 (7) Applicable Holder

Symbol	Applicable Holder
S	GNDIS type

Table 8 (8) Chipbreaker

Symbol	Applications
MG	Multi-functional: General-purpose
ML	Multi-functional: Low-feed
GG	Grooving: General-purpose
GL	Grooving: Low-feed
GF	Grooving: Low Cutting Force
CG	Cut-off: General-purpose
CF	Cut-off: Low Cutting Force
RG	External Necking
RN	Profiling / Necking
GA	Non-Ferrous Metals

Table 9 (9) No. of Cutting Edges

Symbol	No. of Cutting Edges
No	2-Cornered type
1	1-Cornered type (Dedicated for GNDXL type)

Table 10 (10) Lead Angle

Symbol	PSI
05	5°
10	10°
15	15°

■ Precautionary Notes on Tool Selection

- Select the largest shank size possible.
- It is recommended to mount the holder upside down.
- Select a chipbreaker according to the cutting conditions.
- To ensure adequate chip evacuation, select the smallest corner radius possible unless restrictions apply.
- To ensure rigidity, use a multi-functional type holder if possible, so long as the maximum grooving depth can be achieved.

MEMO

A large grid of dotted lines for writing a memo, covering most of the page below the title.



* For traverse cutting (groove expansion), use a multi-functional or profiling insert.

For Small Lathes, External Multi-Functional (Grooving, Traverse Cutting and Profiling) Clamp-on

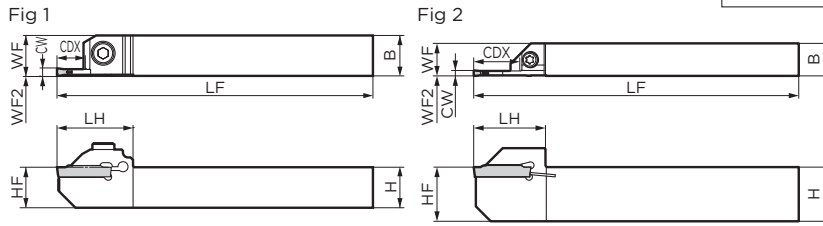
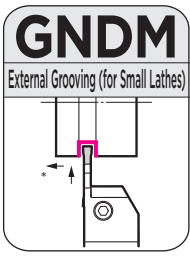

Figure shows right-handed (R) tool.



Holder

Parts

Dimensions (mm)

Cat. No.	Stock		Height	Width	Overall Length	Cutting Edge Distance	Cutting Edge Height	Head	Offset	Width of Cut	Maximum Groove Depth	Max. Cut-off Dia.	Applicable Insert	Fig	Cap Screw		Wrench
	R	L													BFTX0414	N·m	
GNDM R/L1616JX-1.2508	●	●	16	16	120	(16)	16	26	0	1.25	8.0	16	GCM N125005-GF	1	BFTX0414	4.0	LT15-10
R/L1616JX-1.510	●	●	16	16	120	(16)	16	26	0	1.50	10.0	20	GCM N150005-GF	1	BFTX0414	4.0	LT15-10
R/L1616JX-212	●	●	16	16	120	(16)	16	30	0	2.00	12.0	24	GCC □2000-□□	1	BFTX0414	3.0	LT15-10
R/L1616JX-312	●	●	16	16	120	(16)	16	30	0	3.00	12.0	24	GCC □3000-□□	1	BFTX0414	3.0	LT15-10
GNDM R/L2012JX-217	●	●	20	12	120	(12)	20	26.5	0	2.00	17.0	34	GCC □2000-□□	2	BFTX0414	3.0	LT15-10
R/L2012JX-317	●	●	20	12	120	(12)	20	26.5	0	3.00	17.0	34	GCC □3000-□□	2	BFTX0414	3.0	LT15-10

Select holders and inserts with matching width of cut (CW). Refer to P19 for applicable inserts.

The maximum groove depth CDX is the figure during grooving. For maximum depth of cut during traverse cutting and profiling, refer to P11.



For Small Lathes, External Grooving & Cut-off Clamp-on

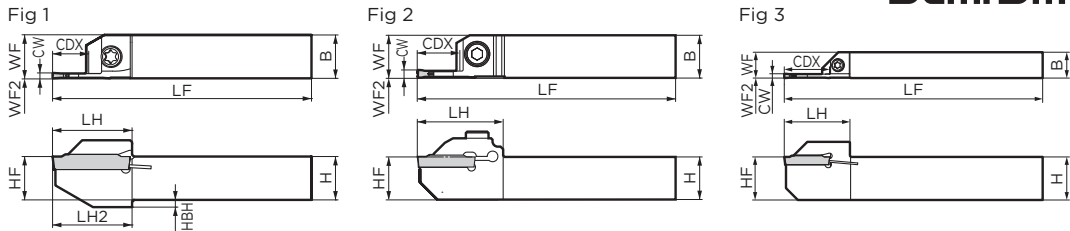
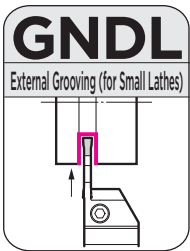

Figure shows right-handed (R) tool.



Holder

Parts

Dimensions (mm)

Cat. No.	Stock		Height	Width	Overall Length	Cutting Edge Distance	Cutting Edge Height	Step	Head	Head	Offset	Width of Cut	Maximum Groove Depth	Max. Cut-off Dia.	Applicable Insert	Fig	Flat Head Screw / Cap Screw		Wrench
	R	L															BFTX0412N	N·m	
GNDL R/L1010JX-1.2510	●	●	10	10	120	(10)	10	2.0	18	18.3	0	1.25	10.0	20	GCM N125005-GF	1	BFTX0412N	3.0	LT15-10
R/L1010JX-1.510	●	●	10	10	120	(10)	10	2.0	18	18.3	0	1.50	10.0	20	GCM N150005-GF	1	BFTX0412N	3.0	LT15-10
R/L1010JX-210	●	●	10	10	120	(10)	10	2.0	22	22.3	0	2.00	10.0	20	GCC □2000-□□	1	BFTX0412N	3.0	LT15-10
R/L1010JX-310	●	●	10	10	120	(10)	10	2.0	22	22.3	0	3.00	10.0	20	GCC □3000-□□	1	BFTX0412N	3.0	LT15-10
GNDL R/L1212JX-1.2512	●	●	12	12	120	(12)	12	2.0	19	19.3	0	1.25	12.0	24	GCM N125005-GF	1	BFTX0412N	3.0	LT15-10
R/L1212JX-1.512	●	●	12	12	120	(12)	12	2.0	19	19.3	0	1.50	12.0	24	GCM N150005-GF	1	BFTX0412N	3.0	LT15-10
R/L1212JX-212.5	●	●	12	12	120	(12)	12	2.0	22	22.3	0	2.00	12.5	25	GCC □2000-□□	1	BFTX0412N	3.0	LT15-10
R/L1212JX-312.5	●	●	12	12	120	(12)	12	2.0	22	22.3	0	3.00	12.5	25	GCC □3000-□□	1	BFTX0412N	3.0	LT15-10
GNDL R/L1616JX-1.2512.5	●	●	16	16	120	(16)	16	—	28	—	0	1.25	12.5	20	GCM N125005-GF	2	BX0515	4.0	LH040
R/L1616JX-1.512.5	●	●	16	16	120	(16)	16	—	28	—	0	1.50	12.5	25	GCM N150005-GF	2	BX0515	4.0	LH040
R/L1616JX-216	●	●	16	16	120	(16)	16	—	32	—	0	2.00	16.0	32	GCC □2000-□□	2	BX0515	4.0	LH040
R/L1616JX-316	●	●	16	16	120	(16)	16	—	32	—	0	3.00	16.0	32	GCC □3000-□□	2	BX0515	4.0	LH040
GNDL R/L2012JX-221	●	●	20	12	120	(12)	20	—	30.5	—	0	2.00	21.0	42	GCC □2000-□□	3	BFTX0414	3.0	LT15-10
R/L2012JX-321	●	●	20	12	120	(12)	20	—	30.5	—	0	3.00	21.0	42	GCC □3000-□□	3	BFTX0414	3.0	LT15-10

Select holders and inserts with matching width of cut (CW). Refer to P19 for applicable inserts.

The maximum groove depth CDX is the figure during grooving. For maximum depth of cut during traverse cutting and profiling, refer to P11.

● mark: Standard stocked item Recommended Tightening Torque (N·m)

Inserts for GNDM type (For Small Lathes)/GNDL type (For Small Lathes) (Coated Carbide/ Cermet/ Cemented Carbide)

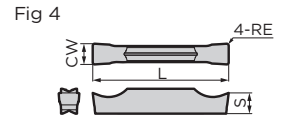
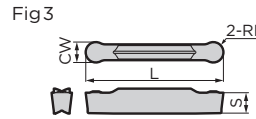
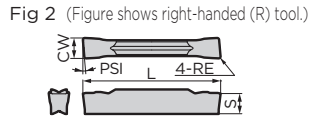
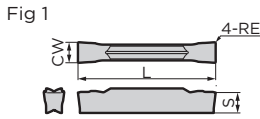

Grooving / Traverse Cutting

Cat. No.	Dimensions (mm)															
	AC8025P	AC8035P	AC830P	AC425K	AC5015S	AC5025S	AC520U	AC530U	Width of Cut CW		Corner Radius RE	Overall Length L	Thickness S	Pcs/Pack	Fig	
									Width of Cut	Tolerance						
GCM N3002-MG N3004-MG	●	●	●	●	●	●	●	●	●	3.0	±0.03	0.2	21.1	3.8	5	1
GCM N2002-ML N3004-ML	—	—	—	—	●	●	●	●	●	2.0	±0.03	0.2	21.1	3.6	5	1
GCM N3002-ML N3004-ML	●	●	●	●	●	●	●	●	●	3.0	±0.03	0.2	21.1	3.8	5	1

Grooving / Cut-off

Cat. No.	Dimensions (mm)															
	AC8025P	AC8035P	AC830P	AC425K	AC5015S	AC5025S	AC520U	AC530U	T2500A	Width of Cut CW		Corner Radius RE	Overall Length L	Thickness S	Pcs/Pack	Fig
										Width of Cut	Tolerance					
GCM N2002-GG N3004-GG	—	●	●	—	●	●	●	●	—	2.0	±0.03	0.2	21.1	3.6	5	1
GCM N2002-GL N2004-GL	—	●	●	—	●	●	●	●	—	2.0	±0.03	0.2	21.1	3.6	5	1
GCM N3002-GL N3004-GL	—	●	●	—	●	●	●	●	—	3.0	±0.03	0.2	21.1	3.8	5	1
GCM N125005-GF N150005-GF	—	—	—	—	—	—	—	—	●	1.25	±0.03	0.05	17.4	3.2	1	1
GCM N2002-GF N2004-GF	—	—	—	—	●	●	●	●	—	2.0	±0.03	0.2	21.1	3.6	5	1
GCM N3002-GF N3004-GF	—	—	—	—	●	●	●	●	—	3.0	±0.03	0.2	21.1	3.8	5	1

Cut-off (Handed Edge)

Cat. No.	Dimensions (mm)														
	AC8035P	AC830P	AC5015S	AC5025S	AC520U	AC530U	AC1030U	Lead Angle	Width of Cut CW		Corner Radius RE	Overall Length L	Thickness S	Pcs/Pack	Fig
									Width of Cut	Tolerance					
GCM R2002-CG-05 L2002-CG-05	●	●	●	●	●	●	—	5°	2.0	±0.03	0.2	21.1	3.6	5	2
GCM R3002-CG-05 L3002-CG-05	●	●	●	●	●	●	—	5°	3.0	±0.03	0.2	21.3	3.8	5	2
GCM R20003-CF-10 L20003-CF-10	—	—	—	—	—	—	●	10°	2.0	±0.08	0.03	22.4	3.6	5	2
GCM R30003-CF-10 L30003-CF-10	—	—	—	—	—	—	●	10°	3.0	±0.08	0.03	22.4	3.8	5	2
GCM R20003-CF-15 L20003-CF-15	—	—	—	—	—	—	●	15°	2.0	±0.08	0.03	22.4	3.6	5	2
GCM R30003-CF-15 L30003-CF-15	—	—	—	—	—	—	●	15°	3.0	±0.08	0.03	22.4	3.8	5	2

GCMR: Right-handed, GCML: Left-handed

External Profiling / External Radius Grooving

Cat. No.	Dimensions (mm)															
	AC8025P	AC8035P	AC830P	AC425K	AC5015S	AC520U	AC530U	T2500A	Width of Cut CW		Corner Radius RE	Overall Length L	Thickness S	Pcs/Pack	Fig	
									Width of Cut	Tolerance						
GCM N3015-RG	●	●	●	●	●	●	●	●	—	3.0	±0.03	1.5	21.1	3.8	5	3

Profiling / Radius Grooving / Necking

Cat. No.	Dimensions (mm)															
	AC8025P	AC8035P	AC830P	AC425K	AC5015S	AC520U	AC530U	Width of Cut CW		Corner Radius RE	Overall Length L	Thickness S	Pcs/Pack	Fig		
								Width of Cut	Tolerance							
GCM N2010-RN N3015-RN	—	—	—	—	●	●	●	—	—	2.0	±0.03	1.0	21.7	3.6	5	3
	—	—	—	—	●	●	●	—	—	3.0	±0.03	1.5	22.6	3.8	5	3

Non-Ferrous Metals

Cat. No.	Dimensions (mm)															
	H10								Width of Cut CW		Corner Radius RE	Overall Length L	Thickness S	Pcs/Pack	Fig	
		Width of Cut	Tolerance													
GCG N2002-GA N3002-GA	●									2.0	±0.025	0.2	21.1	3.6	5	4
	●									3.0	±0.025	0.2	21.1	3.8	5	4

Part Number Suffix Code (Chipbreakers)

Type	Symbol	Applications	Type	Symbol	Applications
Grooving / Traverse Cutting	MG	Multi-functional / General-purpose	Cut-off (Handed Edge)	CG	Cut-off / General-purpose
	ML	Multi-functional / Low-feed		CF	Cut-off / Low cutting force
Grooving / Grooving / Low-feed	GG	Grooving / General-purpose	External Profiling / External Radius Grooving	RG	Profiling / General-purpose
Cut-off	GL	Grooving / Low-feed	Profiling / Radius Grooving / Necking	RN	Facing / Necking / General-purpose
	GF	Grooving / Low cutting force	Non-Ferrous Metals	GA	Non-Ferrous Metals / General-purpose

Chipbreaker Selection P5 Recommended Cutting Conditions P11 Precautions for Use P14

Select holders and inserts with matching width of cut (CW). Not usable with GNDXL type / GNDIS type holders.

● mark: Standard stocked item Blank: Made-to-order item —mark: Not available

Guides
External Dia.
Face
Internal Dia.
Necking
SumiPolygon
Request Form
Application Examples

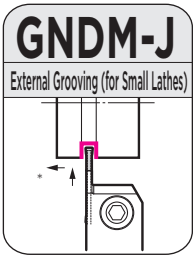

- External
- Zero Offset
- Internal Coolant

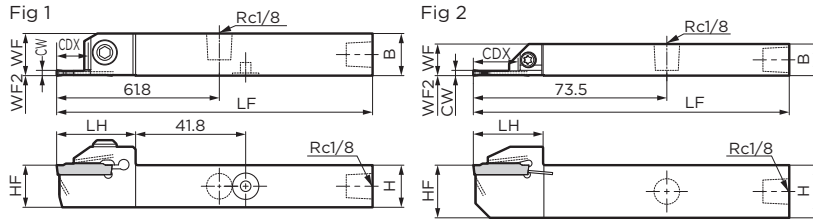

Figure shows right-handed (R) tool.

* For traverse cutting (groove expansion), use a multi-functional or profiling insert.

Holder

Dimensions (mm)

Cat. No.	Stock		Height	Width	Overall Length	Cutting Edge Distance	Cutting Edge Height	Head	Head	Offset	Width of Cut	Maximum Groove Depth	Max. Cut-off Dia.	Applicable Insert	Fig	Flat Head Screw / Cap Screw	N·m	Plug	Top Hex Wrench	Bottom Hex Wrench
	R	L																		
GNDM R/L1616JX-212J	●	●	16	16	120	(16)	16	30.0	0	2.0	12.0	24	GCC □2000-□□	1	CP-M5-20-1	5.0	XPO2	LH040	LH025	
R/L1616JX-312J	●	●	16	16	120	(16)	16	30.0	0	3.0	12.0	24	GCC □3000-□□							
GNDM R/L2012JX-217J	●	●	20	12	120	(12)	20	26.5	0	2.0	17.0	34	GCC □2000-□□	2	BFTX0414	3.0	XPO2	LT15-10	—	
R/L2012JX-317J	●	●	20	12	120	(12)	20	26.5	0	3.0	17.0	34	GCC □3000-□□							

Select holders and inserts with matching width of cut (CW). Refer to P21 for applicable inserts.

The maximum groove depth CDX is the figure during grooving. For maximum depth of cut during traverse cutting and profiling, refer to P11.

Parts

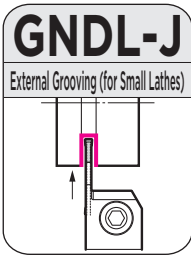
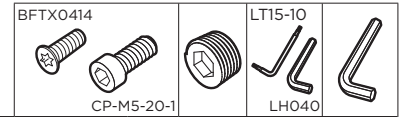

- External
- Zero Offset
- Internal Coolant

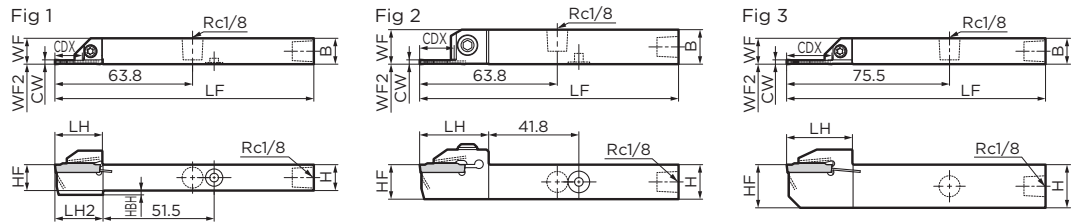

Figure shows right-handed (R) tool.

Holder

Dimensions (mm)

Cat. No.	Stock		Height	Width	Overall Length	Cutting Edge Distance	Cutting Edge Height	Step	Head	Head	Offset	Width of Cut	Maximum Groove Depth	Max. Cut-off Dia.	Applicable Insert	Fig	Flat Head Screw / Cap Screw	N·m	Plug	Top Hex Wrench	Bottom Hex Wrench
	R	L																			
GNDL R/L1212JX-212.5J	●	●	12	12	120	(12)	12	2.0	22.0	22.3	0	2.0	12.5	25	GCC □2000-□□	1	BFTX0415T8R	1.5	XPO2	LT08-06	←
R/L1212JX-312.5J	●	●	12	12	120	(12)	12	2.0	22.0	22.3	0	3.0	12.5	25	GCC □3000-□□						
GNDL R/L1616JX-216J	●	●	16	16	120	(16)	16	—	32.0	—	0	2.0	16.0	32	GCC □2000-□□	2	CP-M5-20-1	5.0	XPO2	LH040	LH025
R/L1616JX-316J	●	●	16	16	120	(16)	16	—	32.0	—	0	3.0	16.0	32	GCC □3000-□□						
GNDL R/L2012JX-221J	●	●	20	12	120	(12)	20	—	30.5	—	0	2.0	21.0	42	GCC □2000-□□	3	BFTX0414	3.0	XPO2	LT15-10	—
R/L2012JX-321J	●	●	20	12	120	(12)	20	—	30.5	—	0	3.0	21.0	42	GCC □3000-□□						

Select holders and inserts with matching width of cut (CW). Refer to P21 for applicable inserts.

The maximum groove depth CDX is the figure during grooving. For maximum depth of cut during traverse cutting and profiling, refer to P11.

Parts

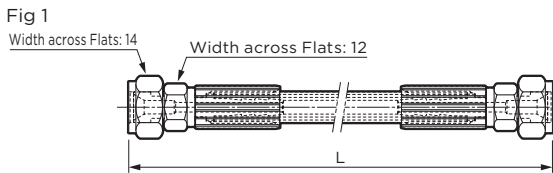
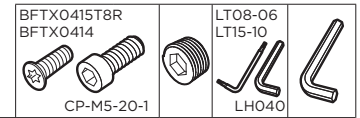

Parts (Hose)

Dimensions (mm)

Cat. No.	Stock	L	Screw Standard	Screw Standard	Fig
J-HOSE-G1/8-G1/8-200	●	200	G1/8	G1/8	1
J-HOSE-G1/8-G1/8-300	●	300	G1/8	G1/8	1

Hoses are sold separately.

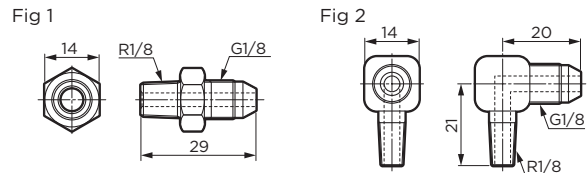
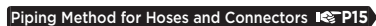

Parts (Connector)

Dimensions (mm)

Cat. No.	Stock	Screw Standard	Screw Standard	Fig
J-G1/8-R1/8-00	●	G1/8	R1/8	1
J-G1/8-R1/8-90	●	G1/8	R1/8	2

Connectors are sold separately.



Inserts for GNDM-J type (For Small Lathes)/GNDL-J type (For Small Lathes) (Coated Carbide/ Cermet/ Cemented Carbide)

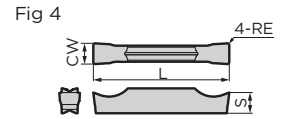
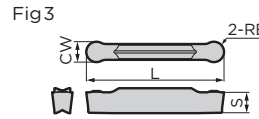
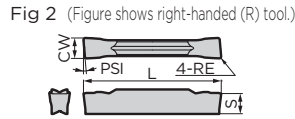
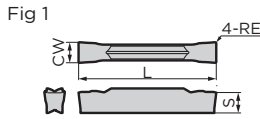

Grooving / Traverse Cutting

Cat. No.	Dimensions (mm)								Pcs/Pack	Fig					
	Width of Cut CW		Corner Radius RE	Overall Length L		Thickness S		Fig							
	Width of Cut	Tolerance		RE	L	S	Pcs/Pack								
GCM N3002-MG N3004-MG	●	●	●	●	●	●	●	●	3.0	±0.03	0.2	21.1	3.8	5	1
GCM N2002-ML N3004-ML	—	—	—	—	—	—	—	—	2.0	±0.03	0.2	21.1	3.6	5	1
GCM N3002-ML N3004-ML	●	●	●	●	●	●	●	●	3.0	±0.03	0.2	21.1	3.8	5	1
GCM N3002-ML N3004-ML	●	●	●	●	●	●	●	●	3.0	±0.03	0.4	21.1	3.8	5	1

Grooving / Cut-off

Cat. No.	Dimensions (mm)								Pcs/Pack	Fig					
	Width of Cut CW		Corner Radius RE	Overall Length L		Thickness S		Fig							
	Width of Cut	Tolerance		RE	L	S	Pcs/Pack								
GCM N2002-GG N3004-GG	●	●	●	●	●	●	●	●	2.0	±0.03	0.2	21.1	3.6	5	1
GCM N2002-GL N2004-GL	—	—	—	—	—	—	—	—	2.0	±0.03	0.2	21.1	3.6	5	1
GCM N2002-GL N2004-GL	●	●	●	●	●	●	●	●	2.0	±0.03	0.4	21.1	3.6	5	1
GCM N3002-GL N3004-GL	●	●	●	●	●	●	●	●	3.0	±0.03	0.2	21.1	3.8	5	1
GCM N3002-GL N3004-GL	●	●	●	●	●	●	●	●	3.0	±0.03	0.4	21.1	3.8	5	1
GCM N2002-GF N2004-GF	—	—	—	—	—	—	—	—	2.0	±0.03	0.2	21.1	3.6	5	1
GCM N2002-GF N2004-GF	●	●	●	●	●	●	●	●	2.0	±0.03	0.4	21.1	3.6	5	1
GCM N3002-GF N3004-GF	●	●	●	●	●	●	●	●	3.0	±0.03	0.2	21.1	3.8	5	1
GCM N3002-GF N3004-GF	●	●	●	●	●	●	●	●	3.0	±0.03	0.4	21.1	3.8	5	1

Cut-off (Handed Edge)

Cat. No.	Dimensions (mm)								Pcs/Pack	Fig						
	Lead Angle PSI	Width of Cut CW		Corner Radius RE	Overall Length L		Thickness S				Fig					
		Width of Cut	Tolerance		RE	L	S	Pcs/Pack								
GCM R2002-CG-05 L2002-CG-05	●	●	●	●	●	●	●	●	5°	2.0	±0.03	0.2	21.1	3.6	5	2
GCM R3002-CG-05 L3002-CG-05	●	●	●	●	●	●	●	●	5°	3.0	±0.03	0.2	21.3	3.8	5	2
GCM R20003-CF-10 L20003-CF-10	—	—	—	—	—	—	—	—	10°	2.0	±0.08	0.03	22.4	3.6	5	2
GCM R30003-CF-10 L30003-CF-10	—	—	—	—	—	—	—	—	10°	3.0	±0.08	0.03	22.4	3.8	5	2
GCM R20003-CF-15 L20003-CF-15	—	—	—	—	—	—	—	—	15°	2.0	±0.08	0.03	22.4	3.6	5	2
GCM R30003-CF-15 L30003-CF-15	—	—	—	—	—	—	—	—	15°	3.0	±0.08	0.03	22.4	3.8	5	2

GCMR: Right-handed, GCML: Left-handed

External Profiling / External Radius Grooving

Cat. No.	Dimensions (mm)								Pcs/Pack	Fig					
	Width of Cut CW		Corner Radius RE	Overall Length L		Thickness S		Fig							
	Width of Cut	Tolerance		RE	L	S	Pcs/Pack								
GCM N3015-RG	●	●	●	●	●	●	●	●	3.0	±0.03	1.5	21.1	3.8	5	3

Profiling / Radius Grooving / Necking

Cat. No.	Dimensions (mm)								Pcs/Pack	Fig					
	Width of Cut CW		Corner Radius RE	Overall Length L		Thickness S		Fig							
	Width of Cut	Tolerance		RE	L	S	Pcs/Pack								
GCM N2010-RN N3015-RN	—	—	—	—	—	—	—	—	2.0	±0.03	1.0	21.7	3.6	5	3
GCM N2010-RN N3015-RN	●	●	●	●	●	●	●	●	3.0	±0.03	1.5	22.6	3.8	5	3

Non-Ferrous Metals

Cat. No.	H10	Dimensions (mm)								Pcs/Pack	Fig				
		Width of Cut CW		Corner Radius RE	Overall Length L		Thickness S		Fig						
		Width of Cut	Tolerance		RE	L	S	Pcs/Pack							
GCG N2002-GA N3002-GA	●	—	—	—	—	—	—	—	2.0	±0.025	0.2	21.1	3.6	5	4
GCG N2002-GA N3002-GA	●	—	—	—	—	—	—	—	3.0	±0.025	0.2	21.1	3.8	5	4

Part Number Suffix Code (Chipbreakers)

Type	Symbol	Applications	Type	Symbol	Applications
Grooving / Traverse Cutting	MG	Multi-functional / General-purpose	Cut-off (Handed Edge)	CG	Cut-off / General-purpose
Grooving / Grooving / Low-feed	ML	Multi-functional / Low-feed	Profiling / Radius Grooving / Necking	RG	Profiling / General-purpose
Grooving / Grooving / Low cutting force	GG	Grooving / General-purpose	Non-Ferrous Metals	GA	Non-Ferrous Metals / General-purpose
Cut-off	GL	Grooving / Low-feed		RN	Facing / Necking / General-purpose
	GF	Grooving / Low cutting force			

Chipbreaker Selection P5 Recommended Cutting Conditions P11 Precautions for Use P14

Select holders and inserts with matching width of cut (CW). Not usable with GNDXL type / GNDIS type holders.

● mark: Standard stocked item Blank: Made-to-order item —mark: Not available

Guides
External Dia.
Face
Internal Dia.
Necking
SumiPolygon
Request Form
Application Examples



* For traverse cutting (groove expansion), use a multi-functional or profiling insert.

External Multi-Functional, Shallow Grooves
 (Grooving, Traverse Cutting and Profiling)
 Clamp-on

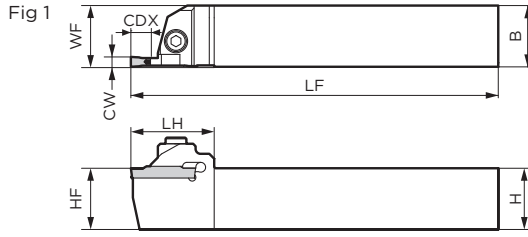
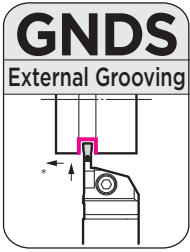

Figure shows right-handed (R) tool.

Holder

Parts

Dimensions (mm)

Cat. No.	Stock		Height H	Width B	Overall Length LF	Cutting Edge Distance WF	Cutting Edge Height HF	Head LH	Width of Cut CW	Maximum Groove Depth CDX	Max. Cut-off Dia.	Applicable Insert	Fig	Parts		
	R	L												Cap Screw	Wrench	
GNDS R/L2020K-206	●	●	20	20	125	20	20	30	2.0	6	12	GC □ 2000-□□	1	BX0520	5.0	LH040
R/L2020K-306	●	●	20	20	125	20	20	30	3.0	6	12	GC □ 3000-□□	1			
R/L2020K-410	●	●	20	20	125	20	20	34	4.0	10	20	GC □ 4000-□□	1			
R/L2020K-510	●	●	20	20	125	20	20	34	5.0	10	20	GC □ N5000-□□	1			
R/L2020K-610	●	●	20	20	125	20	20	34	6.0	10	20	GC □ N6000-□□	1			
GNDS R/L2525M-206	●	●	25	25	150	25	25	30	2.0	6	12	GC □ 2000-□□	1	BX0520	5.0	LH040
R/L2525M-306	●	●	25	25	150	25	25	30	3.0	6	12	GC □ 3000-□□	1			
R/L2525M-410	●	●	25	25	150	25	25	34	4.0	10	20	GC □ 4000-□□	1			
R/L2525M-510	●	●	25	25	150	25	25	34	5.0	10	20	GC □ N5000-□□	1			
R/L2525M-610	●	●	25	25	150	25	25	34	6.0	10	20	GC □ N6000-□□	1			

Select holders and inserts with matching width of cut (CW). Refer to P23 for applicable inserts.

The maximum groove depth CDX is the figure during grooving. For maximum depth of cut during traverse cutting and profiling, refer to P11.

Inserts for GNDS type

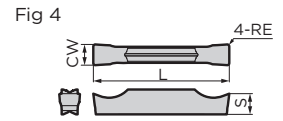
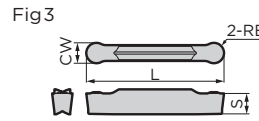
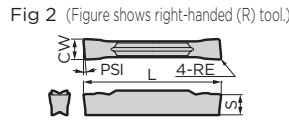
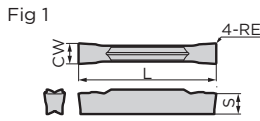

(Coated Carbide/ Cermet/ Cemented Carbide)

Grooving / Traverse Cutting

Dimensions (mm)

Cat. No.	Width of Cut CW							Corner Radius RE	Overall Length L	Thickness S	Pcs/Pack	Fig			
	Width of Cut		RE	L	S	Pcs/Pack	Fig								
	Width of Cut	Tolerance													
GCM N3002-MG N3004-MG	AC8025P AC8035P	AC830P	AC425K	AC5015S	AC5025S	AC520U	AC530U	T2500A	3.0 3.0	±0.03	0.2	21.1	3.8	5	1
GCM N4002-MG N4004-MG N4008-MG	AC8025P AC8035P	AC830P	AC425K	AC5015S	AC5025S	AC520U	AC530U	T2500A	4.0 4.0 4.0	±0.03	0.2	26.4	4.0	5	1
GCM N5004-MG N5008-MG	AC8025P AC8035P	AC830P	AC425K	AC5015S	AC5025S	AC520U	AC530U	T2500A	5.0 5.0	±0.03	0.4	26.4	4.1	1	1
GCM N6004-MG N6008-MG	AC8025P AC8035P	AC830P	AC425K	AC5015S	AC5025S	AC520U	AC530U	T2500A	6.0 6.0	±0.03	0.4	26.4	4.5	1	1
GCM N2002-ML N3002-ML N3004-ML	AC8025P AC8035P	AC830P	AC425K	AC5015S	AC5025S	AC520U	AC530U	T2500A	2.0 3.0 3.0	±0.03	0.2	21.1	3.6 3.8 3.8	5	1
GCM N4002-ML N4004-ML N4008-ML	AC8025P AC8035P	AC830P	AC425K	AC5015S	AC5025S	AC520U	AC530U	T2500A	4.0 4.0 4.0	±0.03	0.2	26.4	4.0	5	1
GCM N5004-ML N5008-ML	AC8025P AC8035P	AC830P	AC425K	AC5015S	AC5025S	AC520U	AC530U	T2500A	5.0 5.0	±0.03	0.4	26.4	4.1	1	1
GCM N6004-ML N6008-ML	AC8025P AC8035P	AC830P	AC425K	AC5015S	AC5025S	AC520U	AC530U	T2500A	6.0 6.0	±0.03	0.4	26.4	4.5	1	1

Cut-off (Handed Edge)

Dimensions (mm)

Cat. No.	Width of Cut CW							Lead Angle	Corner Radius RE	Overall Length L	Thickness S	Pcs/Pack	Fig		
	Width of Cut		RE	L	S	Pcs/Pack	Fig								
	Width of Cut	Tolerance													
GCM R2002-CG-05 L2002-CG-05	AC8025P AC8035P	AC830P	AC425K	AC5015S	AC5025S	AC520U	AC530U	AC1030U	5° 5°	2.0 2.0	±0.03	0.2	21.1	3.6	2
GCM R3002-CG-05 L3002-CG-05	AC8025P AC8035P	AC830P	AC425K	AC5015S	AC5025S	AC520U	AC530U	AC1030U	5° 5°	3.0 3.0	±0.03	0.2	21.3	3.8	5
GCM R4002-CG-05 L4002-CG-05	AC8025P AC8035P	AC830P	AC425K	AC5015S	AC5025S	AC520U	AC530U	AC1030U	5° 5°	4.0 4.0	±0.04	0.2	26.7	4.0	2
GCM R20003-CF-10 L20003-CF-10	AC8025P AC8035P	AC830P	AC425K	AC5015S	AC5025S	AC520U	AC530U	AC1030U	10° 10°	2.0 2.0	±0.08	0.03	22.4	3.6	2
GCM R30003-CF-10 L30003-CF-10	AC8025P AC8035P	AC830P	AC425K	AC5015S	AC5025S	AC520U	AC530U	AC1030U	10° 10°	3.0 3.0	±0.08	0.03	22.4	3.8	5
GCM R20003-CF-15 L20003-CF-15	AC8025P AC8035P	AC830P	AC425K	AC5015S	AC5025S	AC520U	AC530U	AC1030U	15° 15°	2.0 2.0	±0.08	0.03	22.4	3.6	2
GCM R30003-CF-15 L30003-CF-15	AC8025P AC8035P	AC830P	AC425K	AC5015S	AC5025S	AC520U	AC530U	AC1030U	15° 15°	3.0 3.0	±0.08	0.03	22.4	3.8	2

GCMR: Right-handed, GCML: Left-handed

Grooving / Cut-off

Dimensions (mm)

Cat. No.	Width of Cut CW							Corner Radius RE	Overall Length L	Thickness S	Pcs/Pack	Fig		
	Width of Cut		RE	L	S	Pcs/Pack	Fig							
	Width of Cut	Tolerance												
GCM N2002-GG N3002-GG N3004-GG	AC8025P AC8035P	AC830P	AC425K	AC5015S	AC5025S	AC520U	AC530U	T2500A	2.0 3.0 3.0	±0.03	0.2	21.1	3.6 3.8 3.8	5
GCM N4002-GG N4004-GG N5004-GG	AC8025P AC8035P	AC830P	AC425K	AC5015S	AC5025S	AC520U	AC530U	T2500A	4.0 4.0 5.0	±0.03	0.2	26.4	4.0 4.1 4.1	1
GCM N6002-GG N6004-GG	AC8025P AC8035P	AC830P	AC425K	AC5015S	AC5025S	AC520U	AC530U	T2500A	6.0 6.0	±0.03	0.2	26.4	4.5	1
GCM N2002-GL N2004-GL	AC8025P AC8035P	AC830P	AC425K	AC5015S	AC5025S	AC520U	AC530U	T2500A	2.0 2.0	±0.03	0.2	21.1	3.6	5
GCM N3002-GL N3004-GL	AC8025P AC8035P	AC830P	AC425K	AC5015S	AC5025S	AC520U	AC530U	T2500A	3.0 3.0	±0.03	0.2	21.1	3.8	1
GCM N4002-GL N4004-GL	AC8025P AC8035P	AC830P	AC425K	AC5015S	AC5025S	AC520U	AC530U	T2500A	4.0 4.0	±0.03	0.2	26.4	4.0	5
GCM N5002-GL N5004-GL	AC8025P AC8035P	AC830P	AC425K	AC5015S	AC5025S	AC520U	AC530U	T2500A	5.0 5.0	±0.03	0.2	26.4	4.1	1
GCM N6002-GL N6004-GL	AC8025P AC8035P	AC830P	AC425K	AC5015S	AC5025S	AC520U	AC530U	T2500A	6.0 6.0	±0.03	0.2	26.4	4.5	1
GCM N125005-GF N150005-GF	AC8025P AC8035P	AC830P	AC425K	AC5015S	AC5025S	AC520U	AC530U	T2500A	1.25 1.5	±0.03	0.05	17.4	3.2 3.7	1
GCM N2002-GF N2004-GF	AC8025P AC8035P	AC830P	AC425K	AC5015S	AC5025S	AC520U	AC530U	T2500A	2.0 2.0	±0.03	0.2	21.1	3.6	5
GCM N3002-GF N3004-GF	AC8025P AC8035P	AC830P	AC425K	AC5015S	AC5025S	AC520U	AC530U	T2500A	3.0 3.0	±0.03	0.2	21.1	3.8	1
GCM N4002-GF N4004-GF	AC8025P AC8035P	AC830P	AC425K	AC5015S	AC5025S	AC520U	AC530U	T2500A	4.0 4.0	±0.03	0.2	26.4	4.0	1
GCM N5002-GF N5004-GF	AC8025P AC8035P	AC830P	AC425K	AC5015S	AC5025S	AC520U	AC530U	T2500A	5.0 5.0	±0.03	0.2	26.4	4.1	1
GCM N6002-GF N6004-GF	AC8025P AC8035P	AC830P	AC425K	AC5015S	AC5025S	AC520U	AC530U	T2500A	6.0 6.0	±0.03	0.2	26.4	4.5	1

Profiling / Radius Grooving / Necking

Dimensions (mm)

Cat. No.	Width of Cut CW							Corner Radius RE	Overall Length L	Thickness S	Pcs/Pack	Fig		
	Width of Cut		RE	L	S	Pcs/Pack	Fig							
	Width of Cut	Tolerance												
GCM N2010-RN N3015-RN	AC8025P AC8035P	AC830P	AC425K	AC5015S	AC5025S	AC520U	AC530U	AC1030U	2.0 3.0	±0.03	1.0	21.7	3.6 3.8	5
GCM N4020-RN N5025-RN	AC8025P AC8035P	AC830P	AC425K	AC5015S	AC5025S	AC520U	AC530U	AC1030U	4.0 5.0	±0.03	2.0	28.2	4.0 4.1	3
GCM N6030-RN	AC8025P AC8035P	AC830P	AC425K	AC5015S	AC5025S	AC520U	AC530U	AC1030U	6.0	±0.03	3.0	28.3	4.5	3

Non-Ferrous Metals

Dimensions (mm)

Cat. No.	H10	Width of Cut CW							Corner Radius RE	Overall Length L	Thickness S	Pcs/Pack	Fig
		Width of Cut		RE	L	S	Pcs/Pack	Fig					
		Width of Cut	Tolerance										
GCG N2002-GA N3002-GA	●	2.0 3.0	±0.025 ±0.025	0.2	21.1	3.6 3.8	4	4					
GCG N4004-GA N5004-GA N6004-GA	●	4.0 5.0 6.0	±0.025 ±0.025 ±0.025	0.4	26.4	4.0 4.1 4.5	5	4 4 4					

Part Number Suffix Code (Chipbreakers)

Type	Symbol	Applications	Type	Symbol	Applications
Grooving / Traverse Cutting	MG ML	Multi-functional / General-purpose Multi-functional / Low-feed	Cut-off (Handed Edge)	CG CF	Cut-off / General-purpose Cut-off / Low cutting force
Grooving / Cut-off	GG GL GF	Grooving / General-purpose Grooving / Low-feed Grooving / Low cutting force	External Profiling / External Radius Grooving	RG	Profiling / General-purpose
			Profiling / Radius Grooving / Necking	RN	Facing / Necking / General-purpose
			Non-Ferrous Metals	GA	Non-Ferrous Metals / General-purpose

Chipbreaker Selection Recommended Cutting Conditions Precautions for Use

Select holders and inserts with matching width of cut (CW). Not usable with GNDXL type / GNDIS type holders.

● mark: Standard stocked item Blank: Made-to-order item —mark: Not available

Guides
External Dia.
Face
Internal Dia.
Necking
SumiPolygon
Request Form
Application Examples



* For traverse cutting (groove expansion), use a multi-functional or profiling insert.

External Multi-Functional (Grooving, Traverse Cutting and Profiling) Clamp-on

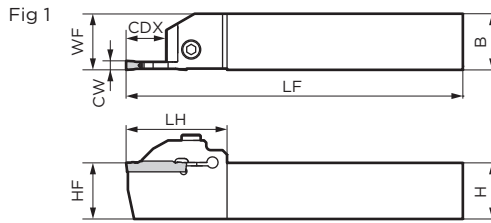
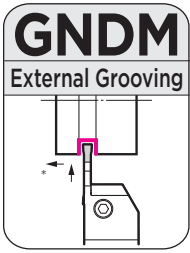

Figure shows right-handed (R) tool.

Holder

Parts

Dimensions (mm)

Cat. No.	Stock		Height H	Width B	Overall Length LF	Cutting Edge Distance WF	Cutting Edge Height HF	Head LH	Width of Cut CW	Maximum Groove Depth CDX	Max. Cut-off Dia.	Applicable Insert	Fig	Cap Screw		Wrench
	R	L												N-m		
GNDM R/L2020K-1.2510	●	●	20	20	125	20	20	34.0	1.25	10	20	GCM N125005-GF	1	BX0520	5.0	LH040
R/L2020K-1.510	●	●	20	20	125	20	20	34.0	1.50	10	20	GCM N150005-GF	1			
R/L2020K-210	●	●	20	20	125	20	20	33.6	2.00	10	20	GCM N2000-□□	1			
R/L2020K-312	●	●	20	20	125	20	20	36.6	3.00	12	24	GCM N3000-□□	1			
R/L2020K-418	●	●	20	20	125	20	20	45.0	4.00	18	36	GCM N4000-□□	1			
R/L2020K-518	●	●	20	20	125	20	20	45.0	5.00	18	36	GCM N5000-□□	1			
R/L2020K-618	●	●	20	20	125	20	20	45.0	6.00	18	36	GCM N6000-□□	1			
GNDM R/L2525M-1.2510	●	●	25	25	150	25	25	36.0	1.25	10	20	GCM N125005-GF	1	BX0520	5.0	LH040
R/L2525M-1.510	●	●	25	25	150	25	25	36.0	1.50	10	20	GCM N150005-GF	1			
R/L2525M-210	●	●	25	25	150	25	25	33.6	2.00	10	20	GCM N2000-□□	1			
R/L2525M-312	●	●	25	25	150	25	25	36.6	3.00	12	24	GCM N3000-□□	1			
R/L2525M-418	●	●	25	25	150	25	25	45.0	4.00	18	36	GCM N4000-□□	1			
R/L2525M-518	●	●	25	25	150	25	25	45.0	5.00	18	36	GCM N5000-□□	1			
R/L2525M-618	●	●	25	25	150	25	25	45.0	6.00	18	36	GCM N6000-□□	1			
GNDM R/L3225P-312			32	25	170	25	32	36.6	3.00	12	24	GCM N3000-□□	1	BX0520	5.0	LH040
R/L3225P-418			32	25	170	25	32	45.0	4.00	18	36	GCM N4000-□□	1			
R/L3225P-518			32	25	170	25	32	45.0	5.00	18	36	GCM N5000-□□	1			
R/L3225P-618			32	25	170	25	32	45.0	6.00	18	36	GCM N6000-□□	1			
R/L3225P-718			32	25	170	25	32	50.0	7.00	18	36	GCM N7000-□□	1			
R/L3225P-818			32	25	170	25	32	50.0	8.00	18	36	GCM N8000-□□	1			
GNDM R/L3232P-312	●	●	32	32	170	32	32	36.6	3.00	12	24	GCM N3000-□□	1			
R/L3232P-418	●	●	32	32	170	32	32	45.0	4.00	18	36	GCM N4000-□□	1			
R/L3232P-518	●	●	32	32	170	32	32	45.0	5.00	18	36	GCM N5000-□□	1			
R/L3232P-618	●	●	32	32	170	32	32	45.0	6.00	18	36	GCM N6000-□□	1			
R/L3232P-718	●	●	32	32	170	32	32	50.0	7.00	18	36	GCM N7000-□□	1			
R/L3232P-818	●	●	32	32	170	32	32	50.0	8.00	18	36	GCM N8000-□□	1			

Select holders and inserts with matching width of cut (CW). Refer to P25 for applicable inserts.

The maximum groove depth CDX is the figure during grooving. For maximum depth of cut during traverse cutting and profiling, refer to P11.



* For traverse cutting (groove expansion), use a multi-functional or profiling insert.

External L-Shaped (Side Cut), Multi-Functional (Grooving, Traverse Cutting and Profiling) Clamp-on

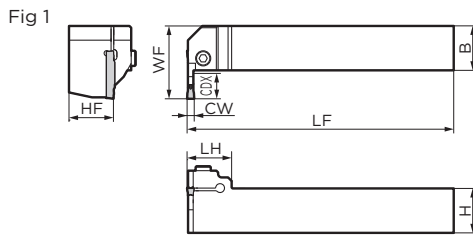
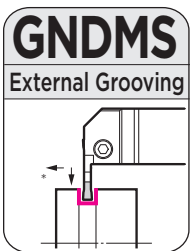

Figure shows right-handed (R) tool.

Holder

Parts

Dimensions (mm)

Cat. No.	Stock		Height H	Width B	Overall Length LF	Cutting Edge Distance WF	Cutting Edge Height HF	Head LH	Width of Cut CW	Maximum Groove Depth CDX	Applicable Insert	Fig	Cap Screw		Wrench
	R	L											N-m		
GNDMS R/L2020K-310	●	●	20	20	125	32	20	25.0	3.0	10	GCM N3000-□□	1	BX0520	5.0	LH040
R/L2020K-412	●	●	20	20	125	34	20	25.0	4.0	12	GCM N4000-□□	1			
R/L2020K-512	●	●	20	20	125	34	20	25.0	5.0	12	GCM N5000-□□	1			
GNDMS R/L2525M-312	●	●	25	25	150	39	25	25.0	3.0	12	GCM N3000-□□	1	BX0520	5.0	LH040
R/L2525M-414	●	●	25	25	150	41	25	25.0	4.0	14	GCM N4000-□□	1			
R/L2525M-514	●	●	25	25	150	41	25	25.0	5.0	14	GCM N5000-□□	1			
R/L2525M-614	●	●	25	25	150	41	25	25.0	6.0	14	GCM N6000-□□	1			

Select holders and inserts with matching width of cut (CW). Refer to P25 for applicable inserts.

The maximum groove depth CDX is the figure during grooving. For maximum depth of cut during traverse cutting and profiling, refer to P11.

● mark: Standard stocked item Recommended Tightening Torque (N-m)

Inserts for GNDM type/GNDMS type

Fig 1

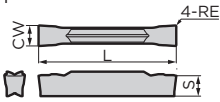
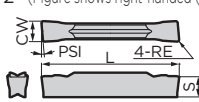

Fig 2 (Figure shows right-handed (R) tool)



(Coated Carbide / Cermet / Cemented Carbide)

Fig 3

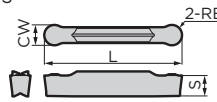
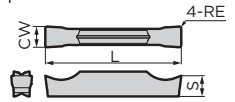

Fig 4



Grooving / Traverse Cutting

Dimensions (mm)

Cat. No.	AC8025P	AC8035P	AC830P	AC425K	AC5015S	AC5025S	AC520U	AC530U	T2500A	Width of Cut CW		Corner Radius RE	Overall Length L	Thickness S	Pcs/Pack	Fig
										Width of Cut	Tolerance					
GCM N3002-MG	●	●	●	●	●	●	●	●	—	3.0	±0.03	0.2	21.1	3.8	5	1
N3004-MG	●	●	●	●	●	●	●	●	—	3.0	±0.03	0.4	21.1	3.8	1	1
GCM N4002-MG	●	●	●	●	●	●	●	●	—	4.0	±0.03	0.2	26.4	4.0	1	1
N4004-MG	●	●	●	●	●	●	●	●	—	4.0	±0.03	0.4	26.4	4.0	1	1
N4008-MG	●	●	●	●	●	●	●	●	—	4.0	±0.03	0.8	26.4	4.0	1	1
GCM N5004-MG	●	●	●	●	●	●	●	●	—	5.0	±0.03	0.4	26.4	4.1	1	1
N5008-MG	●	●	●	●	●	●	●	●	—	5.0	±0.03	0.8	26.4	4.1	1	1
GCM N6004-MG	●	●	●	●	●	●	●	●	—	6.0	±0.03	0.4	26.4	4.5	1	1
N6008-MG	●	●	●	●	●	●	●	●	—	6.0	±0.03	0.8	26.4	4.5	1	1
GCM N7004-MG	●	●	●	●	●	●	●	●	—	7.0	±0.04	0.4	28.8	5.5	1	1
N7008-MG	●	●	●	●	●	●	●	●	—	7.0	±0.04	0.8	28.8	5.5	1	1
GCM N8004-MG	●	●	●	●	●	●	●	●	—	8.0	±0.04	0.4	28.8	6.0	1	1
N8008-MG	●	●	●	●	●	●	●	●	—	8.0	±0.04	0.8	28.8	6.0	1	1
GCM N2002-ML	—	—	—	—	—	—	—	—	—	2.0	±0.03	0.2	21.1	3.6	1	1
N3002-ML	●	●	●	●	●	●	●	●	—	3.0	±0.03	0.2	21.1	3.8	1	1
N3004-ML	●	●	●	●	●	●	●	●	—	3.0	±0.03	0.4	21.1	3.8	1	1
GCM N4002-ML	●	●	●	●	●	●	●	●	—	4.0	±0.03	0.2	26.4	4.0	1	1
N4004-ML	●	●	●	●	●	●	●	●	—	4.0	±0.03	0.4	26.4	4.0	1	1
N4008-ML	●	●	●	●	●	●	●	●	—	4.0	±0.03	0.8	26.4	4.0	1	1
GCM N5004-ML	●	●	●	●	●	●	●	●	—	5.0	±0.03	0.4	26.4	4.1	1	1
N5008-ML	●	●	●	●	●	●	●	●	—	5.0	±0.03	0.8	26.4	4.1	1	1
GCM N6004-ML	●	●	●	●	●	●	●	●	—	6.0	±0.03	0.4	26.4	4.5	1	1
N6008-ML	●	●	●	●	●	●	●	●	—	6.0	±0.03	0.8	26.4	4.5	1	1
GCM N7004-ML	●	●	●	●	●	●	●	●	—	7.0	±0.04	0.4	28.8	5.5	1	1
N7008-ML	●	●	●	●	●	●	●	●	—	7.0	±0.04	0.8	28.8	5.5	1	1
GCM N8004-ML	●	●	●	●	●	●	●	●	—	8.0	±0.04	0.4	28.8	6.0	1	1
N8008-ML	●	●	●	●	●	●	●	●	—	8.0	±0.04	0.8	28.8	6.0	1	1

Cut-off (Handed Edge)

Dimensions (mm)

Cat. No.	AC8025P	AC8035P	AC830P	AC5015S	AC5025S	AC520U	AC530U	AC1030U	Lead Angle PSI	Width of Cut CW		Corner Radius RE	Overall Length L	Thickness S	Pcs/Pack	Fig
										Width of Cut	Tolerance					
GCM R2002-CG-05	●	●	●	●	●	●	●	—	5°	2.0	±0.03	0.2	21.1	3.6	5	2
L2002-CG-05	●	●	●	●	●	●	●	—	5°	2.0	±0.03	0.2	21.1	3.6	2	2
GCM R3002-CG-05	●	●	●	●	●	●	●	—	5°	3.0	±0.03	0.2	21.3	3.8	2	2
L3002-CG-05	●	●	●	●	●	●	●	—	5°	3.0	±0.03	0.2	21.3	3.8	2	2
GCM R4002-CG-05	●	●	●	●	●	●	●	—	5°	4.0	±0.04	0.2	26.7	4.0	2	2
L4002-CG-05	●	●	●	●	●	●	●	—	5°	4.0	±0.04	0.2	26.7	4.0	2	2
GCM R20003-CF-10	—	—	—	—	—	—	—	—	10°	2.0	±0.08	0.03	22.4	3.6	5	2
L20003-CF-10	—	—	—	—	—	—	—	—	10°	2.0	±0.08	0.03	22.4	3.6	2	2
GCM R30003-CF-10	—	—	—	—	—	—	—	—	10°	3.0	±0.08	0.03	22.4	3.8	2	2
L30003-CF-10	—	—	—	—	—	—	—	—	10°	3.0	±0.08	0.03	22.4	3.8	2	2
GCM R20003-CF-15	—	—	—	—	—	—	—	—	15°	2.0	±0.08	0.03	22.4	3.6	5	2
L20003-CF-15	—	—	—	—	—	—	—	—	15°	2.0	±0.08	0.03	22.4	3.6	2	2
GCM R30003-CF-15	—	—	—	—	—	—	—	—	15°	3.0	±0.08	0.03	22.4	3.8	2	2
L30003-CF-15	—	—	—	—	—	—	—	—	15°	3.0	±0.08	0.03	22.4	3.8	2	2

GCMR: Right-handed, GCM: Left-handed

External Profiling / External Radius Grooving

Dimensions (mm)

Cat. No.	AC8025P	AC8035P	AC830P	AC425K	AC5015S	AC5025S	AC520U	AC530U	T2500A	Width of Cut CW		Corner Radius RE	Overall Length L	Thickness S	Pcs/Pack	Fig
										Width of Cut	Tolerance					
GCM N3015-RG	●	●	●	●	●	●	●	●	—	3.0	±0.03	1.5	21.1	3.8	5	3
N4020-RG	●	●	●	●	●	●	●	●	—	4.0	±0.03	2.0	26.4	4.0	3	3
GCM N5025-RG	●	●	●	●	●	●	●	●	—	5.0	±0.03	2.5	27.2	4.1	3	3
N6030-RG	●	●	●	●	●	●	●	●	—	6.0	±0.03	3.0	27.5	4.5	3	3
GCM N7035-RG	●	●	●	●	●	●	●	●	—	7.0	±0.04	3.5	29.1	5.5	3	3
N8040-RG	●	●	●	●	●	●	●	●	—	8.0	±0.04	4.0	29.3	6.0	3	3

Grooving / Cut-off

Dimensions (mm)

Cat. No.	AC8025P	AC8035P	AC830P	AC425K	AC5015S	AC5025S	AC520U	AC530U	T2500A	Width of Cut CW		Corner Radius RE	Overall Length L	Thickness S	Pcs/Pack	Fig
										Width of Cut	Tolerance					
GCM N2002-GG	●	●	●	●	●	●	●	●	—	2.0	±0.03	0.2	21.1	3.6	5	1
N3002-GG	●	●	●	●	●	●	●	●	—	3.0	±0.03	0.2	21.1	3.8	1	1
N3004-GG	●	●	●	●	●	●	●	●	—	3.0	±0.03	0.4	21.1	3.8	1	1
GCM N4002-GG	●	●	●	●	●	●	●	●	—	4.0	±0.03	0.2	26.4	4.0	1	1
N4004-GG	●	●	●	●	●	●	●	●	—	4.0	±0.03	0.4	26.4	4.0	1	1
GCM N5002-GG	●	●	●	●	●	●	●	●	—	5.0	±0.03	0.2	26.4	4.1	1	1
N5004-GG	●	●	●	●	●	●	●	●	—	5.0	±0.03	0.4	26.4	4.1	1	1
GCM N6002-GG	●	●	●	●	●	●	●	●	—	6.0	±0.03	0.2	26.4	4.5	1	1
N6004-GG	●	●	●	●	●	●	●	●	—	6.0	±0.03	0.4	26.4	4.5	1	1
GCM N7004-GG	●	●	●	●	●	●	●	●	—	7.0	±0.04	0.4	28.8	5.5	1	1
N8004-GG	●	●	●	●	●	●	●	●	—	8.0	±0.04	0.4	28.8	6.0	1	1
GCM N2002-GL	—	—	—	—	—	—	—	—	—	2.0	±0.03	0.2	21.1	3.6	1	1
N2004-GL	●	●	●	●	●	●	●	●	—	2.0	±0.03	0.4	21.1	3.6	1	1
GCM N3002-GL	●	●	●	●	●	●	●	●	—	3.0	±0.03	0.2	21.1	3.8	1	1
N3004-GL	●	●	●	●	●	●	●	●	—	3.0	±0.03	0.4	21.1	3.8	1	1
GCM N4002-GL	●	●	●	●	●	●	●	●	—	4.0	±0.03	0.2	26.4	4.0	1	1
N4004-GL	●	●	●	●	●	●	●	●	—	4.0	±0.03	0.4	26.4	4.0	1	1
GCM N5002-GL	●	●	●	●	●	●	●	●	—	5.0	±0.03	0.2	26.4	4.1	1	1
N5004-GL	●	●	●	●	●	●	●	●	—	5.0	±0.03	0.4	26.4	4.1	1	1
GCM N6002-GL	●	●	●	●	●	●	●	●	—	6.0	±0.03	0.2	26.4	4.5	1	1
N6004-GL	●	●	●	●	●	●	●	●	—	6.0	±0.03	0.4	26.4	4.5	1	1
GCM N7004-GL	●	●	●	●	●	●	●	●	—	7.0	±0.04	0.4	28.8	5.5	1	1
N8004-GL	●	●	●	●	●	●	●	●	—	8.0	±0.04	0.4	28.8	6.0	1	1
GCM N125005-GF	—	—	—	—	—	—	—	—	—	1.25	±0.03	0.05	17.4	3.2	1	1
N150005-GF	—	—	—	—	—	—	—	—	—	1.5	±0.03	0.05	17.8	3.7	1	1
GCM N2002-GF	●	●	●	●	●	●	●	●	—	2.0	±0.03	0.2	21.1	3.6	1	1
N2004-GF	●	●	●	●	●	●	●	●	—	2.0	±0.03	0.4	21.1	3.6	1	1
GCM N3002-GF	●	●	●	●	●	●	●	●	—	3.0	±0.03	0.2	21.1	3.8	1	1
N3004-GF	●	●	●	●	●	●	●	●	—	3.0	±0.03	0.4	21.1	3.8	1	1
GCM N4002-GF	●	●	●	●	●	●	●	●	—	4.0	±0.03	0.2	26.4	4.0	1	1
N4004-GF	●	●	●	●	●	●	●	●	—	4.0	±0.03	0.4	26.4	4.0	1	1
GCM N5002-GF	●	●	●	●	●	●	●	●	—	5.0	±0.03	0.2	26.4	4.1	1	1
N5004-GF	●	●	●	●	●	●	●	●	—	5.0	±0.03	0.4	26.4	4.1	1	1
GCM N6002-GF	●	●	●	●												



* For traverse cutting (groove expansion), use a multi-functional or profiling insert.

External Multi-Functional
 (Grooving, Traverse Cutting and Profiling)
 Internal Coolant Supply, Clamp-on

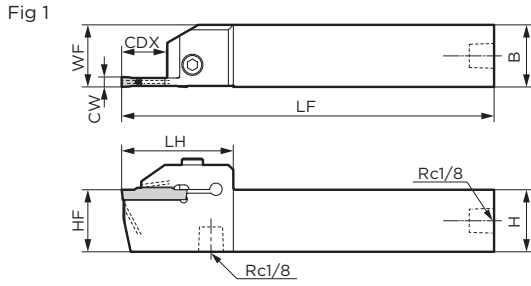

Figure shows right-handed (R) tool.

Holder

Parts

Dimensions (mm)

Cat. No.	Stock		Height H	Width B	Overall Length LF	Cutting Edge Distance WF	Cutting Edge Height HF	Head LH	Width of Cut CW	Maximum Groove Depth CDX	Max. Cut-off Dia.	Applicable Insert	Fig	Dimensions (mm)			
	R	L												Cap Screw	Plug	Wrench	
GNDM R/L2020K-210J	●	●	20	20	125	20	20	33.6	2.00	10	20	GC □ 2000-□□	1	BX0520	6.0	XP02	LH040
R/L2020K-312J	●	●	20	20	125	20	20	36.6	3.00	12	24	GC □ 3000-□□	1				
R/L2020K-418J	●	●	20	20	125	20	20	45	4.00	18	36	GC □ 4000-□□	1				
R/L2020K-518J	●	●	20	20	125	20	20	45	5.00	18	36	GC □ N5000-□□	1				
R/L2020K-618J	●	●	20	20	125	20	20	45	6.00	18	36	GC □ N6000-□□	1				
GNDM R/L2525K-210J	●	●	25	25	125	25	25	33.6	2.00	10	20	GC □ 2000-□□	1	BX0520	6.0	XP02	LH040
R/L2525K-312J	●	●	25	25	125	25	25	36.6	3.00	12	24	GC □ 3000-□□	1				
R/L2525K-418J	●	●	25	25	125	25	25	45	4.00	18	36	GC □ 4000-□□	1				
R/L2525K-518J	●	●	25	25	125	25	25	45	5.00	18	36	GC □ N5000-□□	1				
R/L2525K-618J	●	●	25	25	125	25	25	45	6.00	18	36	GC □ N6000-□□	1				

Select holders and inserts with matching width of cut (CW). Refer to P27 for applicable inserts.

The maximum groove depth CDX is the figure during grooving. For maximum depth of cut during traverse cutting and profiling, refer to P11.

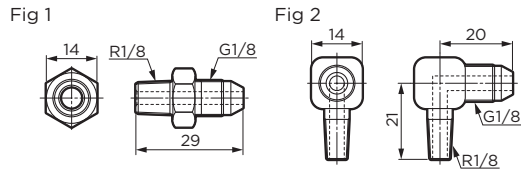
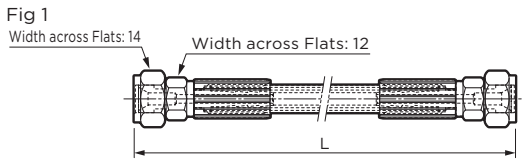

Parts (Hose)

Dimensions (mm)

Cat. No.	Stock	L	Screw Standard	Screw Standard	Fig
J-HOSE-G1/8-G1/8-200	●	200	G1/8	G1/8	1
J-HOSE-G1/8-G1/8-300	●	300	G1/8	G1/8	1

Hoses are sold separately.

Piping Method for Hoses and Connectors **P15**

Parts (Connector)

Dimensions (mm)

Cat. No.	Stock	Screw Standard	Screw Standard	Fig
J-G1/8-R1/8-00	●	G1/8	R1/8	1
J-G1/8-R1/8-90	●	G1/8	R1/8	2

Connectors are sold separately.

Piping Method for Hoses and Connectors **P15**

Inserts for GNDM-J type

Fig 1

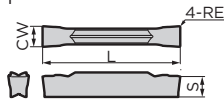

Fig 2 (Figure shows right-handed (R) tool)

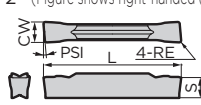

Fig 3

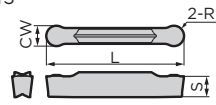
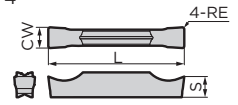

Fig 4



(Coated Carbide/ Cermet/ Cemented Carbide)

Grooving / Traverse Cutting

Dimensions (mm)

Cat. No.	AC8025P	AC8035P	AC830P	AC425K	AC5015S	AC5025S	AC520U	AC530U	T2500A	Width of Cut CW				Pcs/Pack	Fig	
										Width of Cut		RE	L			S
										Width of Cut	Tolerance					
GCM N3002-MG	●	●	●	●	●	●	●	●	●	3.0	±0.03	0.2	21.1	3.8	1	
N3004-MG	●	●	●	●	●	●	●	●	●	3.0	±0.03	0.4	21.1	3.8	1	
GCM N4002-MG	●	●	●	●	●	●	●	●	●	4.0	±0.03	0.2	26.4	4.0	1	
N4004-MG	●	●	●	●	●	●	●	●	●	4.0	±0.03	0.4	26.4	4.0	1	
N4008-MG	●	●	●	●	●	●	●	●	●	4.0	±0.03	0.8	26.4	4.0	5	
GCM N5004-MG	●	●	●	●	●	●	●	●	●	5.0	±0.03	0.4	26.4	4.1	1	
N5008-MG	●	●	●	●	●	●	●	●	●	5.0	±0.03	0.8	26.4	4.1	1	
GCM N6004-MG	●	●	●	●	●	●	●	●	●	6.0	±0.03	0.4	26.4	4.5	1	
N6008-MG	●	●	●	●	●	●	●	●	●	6.0	±0.03	0.8	26.4	4.5	1	
GCM N2002-ML	●	●	●	●	●	●	●	●	●	2.0	±0.03	0.2	21.1	3.6	1	
N3002-ML	●	●	●	●	●	●	●	●	●	3.0	±0.03	0.2	21.1	3.8	1	
N3004-ML	●	●	●	●	●	●	●	●	●	3.0	±0.03	0.4	21.1	3.8	1	
GCM N4002-ML	●	●	●	●	●	●	●	●	●	4.0	±0.03	0.2	26.4	4.0	1	
N4004-ML	●	●	●	●	●	●	●	●	●	4.0	±0.03	0.4	26.4	4.0	1	
N4008-ML	●	●	●	●	●	●	●	●	●	4.0	±0.03	0.8	26.4	4.0	5	
GCM N5004-ML	●	●	●	●	●	●	●	●	●	5.0	±0.03	0.4	26.4	4.1	1	
N5008-ML	●	●	●	●	●	●	●	●	●	5.0	±0.03	0.8	26.4	4.1	1	
GCM N6004-ML	●	●	●	●	●	●	●	●	●	6.0	±0.03	0.4	26.4	4.5	1	
N6008-ML	●	●	●	●	●	●	●	●	●	6.0	±0.03	0.8	26.4	4.5	1	

Grooving / Cut-off

Dimensions (mm)

Cat. No.	AC8025P	AC8035P	AC830P	AC425K	AC5015S	AC5025S	AC520U	AC530U	T2500A	Width of Cut CW				Pcs/Pack	Fig	
										Width of Cut		RE	L			S
										Width of Cut	Tolerance					
GCM N2002-GG	●	●	●	●	●	●	●	●	●	2.0	±0.03	0.2	21.1	3.6	1	
GCM N3002-GG	●	●	●	●	●	●	●	●	●	3.0	±0.03	0.2	21.1	3.8	1	
N3004-GG	●	●	●	●	●	●	●	●	●	3.0	±0.03	0.4	21.1	3.8	1	
GCM N4002-GG	●	●	●	●	●	●	●	●	●	4.0	±0.03	0.2	26.4	4.0	1	
N4004-GG	●	●	●	●	●	●	●	●	●	4.0	±0.03	0.4	26.4	4.0	5	
GCM N5002-GG	●	●	●	●	●	●	●	●	●	5.0	±0.03	0.2	26.4	4.1	1	
N5004-GG	●	●	●	●	●	●	●	●	●	5.0	±0.03	0.4	26.4	4.1	1	
GCM N6002-GG	●	●	●	●	●	●	●	●	●	6.0	±0.03	0.2	26.4	4.5	1	
N6004-GG	●	●	●	●	●	●	●	●	●	6.0	±0.03	0.4	26.4	4.5	1	
GCM N2002-GL	●	●	●	●	●	●	●	●	●	2.0	±0.03	0.2	21.1	3.6	1	
N2004-GL	●	●	●	●	●	●	●	●	●	2.0	±0.03	0.4	21.1	3.6	1	
GCM N3002-GL	●	●	●	●	●	●	●	●	●	3.0	±0.03	0.2	21.1	3.8	1	
N3004-GL	●	●	●	●	●	●	●	●	●	3.0	±0.03	0.4	21.1	3.8	1	
GCM N4002-GL	●	●	●	●	●	●	●	●	●	4.0	±0.03	0.2	26.4	4.0	1	
N4004-GL	●	●	●	●	●	●	●	●	●	4.0	±0.03	0.4	26.4	4.0	5	
GCM N5002-GL	●	●	●	●	●	●	●	●	●	5.0	±0.03	0.2	26.4	4.1	1	
N5004-GL	●	●	●	●	●	●	●	●	●	5.0	±0.03	0.4	26.4	4.1	1	
GCM N6002-GL	●	●	●	●	●	●	●	●	●	6.0	±0.03	0.2	26.4	4.5	1	
N6004-GL	●	●	●	●	●	●	●	●	●	6.0	±0.03	0.4	26.4	4.5	1	
GCM N125005-GF	●	●	●	●	●	●	●	●	●	1.25	±0.03	0.05	17.4	3.2	1	
GCM N150005-GF	●	●	●	●	●	●	●	●	●	1.5	±0.03	0.05	17.8	3.7	1	
GCM N2002-GF	●	●	●	●	●	●	●	●	●	2.0	±0.03	0.2	21.1	3.6	1	
N2004-GF	●	●	●	●	●	●	●	●	●	2.0	±0.03	0.4	21.1	3.6	1	
GCM N3002-GF	●	●	●	●	●	●	●	●	●	3.0	±0.03	0.2	21.1	3.8	1	
N3004-GF	●	●	●	●	●	●	●	●	●	3.0	±0.03	0.4	21.1	3.8	1	
GCM N4002-GF	●	●	●	●	●	●	●	●	●	4.0	±0.03	0.2	26.4	4.0	1	
N4004-GF	●	●	●	●	●	●	●	●	●	4.0	±0.03	0.4	26.4	4.0	1	
GCM N5002-GF	●	●	●	●	●	●	●	●	●	5.0	±0.03	0.2	26.4	4.1	1	
N5004-GF	●	●	●	●	●	●	●	●	●	5.0	±0.03	0.4	26.4	4.1	1	
GCM N6002-GF	●	●	●	●	●	●	●	●	●	6.0	±0.03	0.2	26.4	4.5	1	
N6004-GF	●	●	●	●	●	●	●	●	●	6.0	±0.03	0.4	26.4	4.5	1	

Cut-off (Handed Edge)

Dimensions (mm)

Cat. No.	AC8035P	AC830P	AC5015S	AC5025S	AC520U	AC530U	AC1030U	Lead Angle	Width of Cut CW				Pcs/Pack	Fig	
									Width of Cut		RE	L			S
									Width of Cut	Tolerance					
GCM R2002-CG-05	●	●	●	●	●	●	●	5°	2.0	±0.03	0.2	21.1	3.6	2	
L2002-CG-05	●	●	●	●	●	●	●	5°	2.0	±0.03	0.2	21.1	3.6	2	
GCM R3002-CG-05	●	●	●	●	●	●	●	5°	3.0	±0.03	0.2	21.3	3.8	2	
L3002-CG-05	●	●	●	●	●	●	●	5°	3.0	±0.03	0.2	21.3	3.8	2	
GCM R4002-CG-05	●	●	●	●	●	●	●	5°	4.0	±0.04	0.2	26.7	4.0	2	
L4002-CG-05	●	●	●	●	●	●	●	5°	4.0	±0.04	0.2	26.7	4.0	2	
GCM R20003-CF-10	●	●	●	●	●	●	●	10°	2.0	±0.08	0.03	22.4	3.6	2	
L20003-CF-10	●	●	●	●	●	●	●	10°	2.0	±0.08	0.03	22.4	3.6	2	
GCM R30003-CF-10	●	●	●	●	●	●	●	10°	3.0	±0.08	0.03	22.4	3.8	2	
L30003-CF-10	●	●	●	●	●	●	●	10°	3.0	±0.08	0.03	22.4	3.8	2	
GCM R20003-CF-15	●	●	●	●	●	●	●	15°	2.0	±0.08	0.03	22.4	3.6	2	
L20003-CF-15	●	●	●	●	●	●	●	15°	2.0	±0.08	0.03	22.4	3.6	2	
GCM R30003-CF-15	●	●	●	●	●	●	●	15°	3.0	±0.08	0.03	22.4	3.8	2	
L30003-CF-15	●	●	●	●	●	●	●	15°	3.0	±0.08	0.03	22.4	3.8	2	

GCMR: Right-handed, GCML: Left-handed

External Profiling / External Radius Grooving

Dimensions (mm)

Cat. No.	AC8025P	AC8035P	AC830P	AC425K	AC5015S	AC5025S	AC520U	AC530U	T2500A	Width of Cut CW				Pcs/Pack	Fig	
										Width of Cut		RE	L			S
										Width of Cut	Tolerance					
GCM N3015-RG	●	●	●	●	●	●	●	●	●	3.0	±0.03	1.5	21.1	3.8	3	
N4020-RG	●	●	●	●	●	●	●	●	●	4.0	±0.03	2.0	26.4	4.0	3	
GCM N5025-RG	●	●	●	●	●	●	●	●	●	5.0	±0.03	2.5	27.2	4.1	3	
N6030-RG	●	●	●	●	●	●	●	●	●	6.0	±0.03	3.0	27.5	4.5	3	

Profiling / Radius Grooving / Necking

Dimensions (mm)

Cat. No.	AC8025P	AC8035P	AC830P	AC425K	AC5015S	AC5025S	AC520U	AC530U	Width of Cut CW				Pcs/Pack	Fig	
									Width of Cut		RE	L			S
									Width of Cut	Tolerance					
GCM N2010-RN	●	●	●	●	●	●	●	●	2.0	±0.03	1.0	21.7	3.6	3	
N3015-RN	●	●	●	●	●	●	●	●	3.0	±0.03	1.5	22.6	3.8	3	
N4020-RN	●	●	●	●	●	●	●	●	4.0	±0.03	2.0	28.2	4.0	5	
N5025-RN	●	●	●	●	●	●	●	●	5.0	±0.03	2.5	28.3	4.1	3	
N6030-RN	●	●	●	●	●	●	●	●	6.0	±0.03	3.0	28.3	4.5	3	

Non-Ferrous Metals

Dimensions (mm)

Cat. No.	HT0	Width of Cut CW				Pcs/Pack	Fig	
		Width of Cut		RE	L			S
		Width of Cut	Tolerance					
GCG N2002-GA	●	2.0	±0.025	0.2	21.1	3.6	4	
N3002-GA	●	3.0	±0.025	0.2	21.1	3.8	4	
GCG N4004-GA	●	4.0	±0.025	0.4	26.4	4.0	5	
N5004-GA	●	5.0	±0.025	0.4	26.4	4.1	4	
N6004-GA	●	6.0	±0.025	0.4	26.4	4.5	4	

Part Number Suffix Code (Chipbreakers)

Type	Symbol	Applications	Type	Symbol	Applications
Grooving / Traverse Cutting	MG	Multi-functional / General-purpose	Cut-off (Handed Edge)	CG	Cut-off / General-purpose
	ML	Multi-functional / Low-feed		CF	Cut-off / Low cutting force
Grooving / Cut-off	GG	Grooving / General-purpose	External Profiling / External Radius Grooving	RG	Profiling / General-purpose
	GL	Grooving / Low-feed	Profiling / Radius Grooving / Necking	RN	Facing / Necking / General-purpose
	GF	Grooving / Low cutting force	Non-Ferrous Metals	GA	Non-Ferrous Metals / General-purpose



External Deep Grooving & Cut-off
Clamp-on

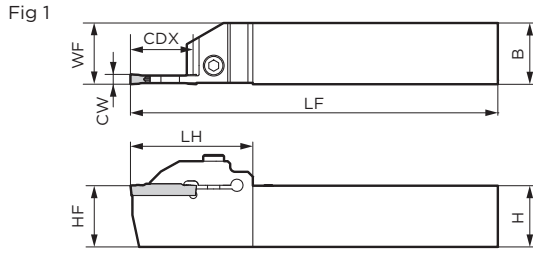

Figure shows right-handed (R) tool.

Holder

Parts

Dimensions (mm)

Cat. No.	Stock		Height H	Width B	Overall Length LF	Cutting Edge Distance WF	Cutting Edge Height HF	Head LH	Width of Cut CW	Maximum Groove Depth CDX	Max. Cut-off Dia.	Applicable Insert	Fig	Cap Screw		Wrench
	R	L												BX0520	N-m	
GNDL R/L2020K-1.2516	●	●	20	20	125	20	20	38.0	1.25	16	32	GCM N125005-GF	1	BX0520	5.0	LH040
R/L2020K-1.516	●	●	20	20	125	20	20	38.0	1.50	16	32	GCM N150005-GF	1			
R/L2020K-220	●	●	20	20	125	20	20	44.5	2.00	20(18)	40	GCC □2000-□□	1			
R/L2020K-320	●	●	20	20	125	20	20	44.5	3.00	20(18)	40	GCC □3000-□□	1			
R/L2020K-425	●	●	20	20	125	20	20	50.0	4.00	25(23)	50	GCC □4000-□□	1			
R/L2020K-525	●	●	20	20	125	20	20	50.0	5.00	25(23)	50	GCC N5000-□□	1			
R/L2020K-625	●	●	20	20	125	20	20	50.0	6.00	25(23)	50	GCC N6000-□□	1			
GNDL R/L2525M-1.2516	●	●	25	25	150	25	25	40.0	1.25	16	32	GCM N125005-GF	1	BX0520	5.0	LH040
R/L2525M-1.516	●	●	25	25	150	25	25	40.0	1.50	16	32	GCM N150005-GF	1			
R/L2525M-220	●	●	25	25	150	25	25	44.5	2.00	20(18)	40	GCC □2000-□□	1			
R/L2525M-320	●	●	25	25	150	25	25	44.5	3.00	20(18)	40	GCC □3000-□□	1			
R/L2525M-425	●	●	25	25	150	25	25	50.0	4.00	25(23)	50	GCC □4000-□□	1			
R/L2525M-525	●	●	25	25	150	25	25	50.0	5.00	25(23)	50	GCC N5000-□□	1			
R/L2525M-625	●	●	25	25	150	25	25	50.0	6.00	25(23)	50	GCC N6000-□□	1			
GNDL R/L3225P-320			32	25	170	25	32	44.5	3.00	20(18)	40	GCC □3000-□□	1	BX0520	5.0	LH040
R/L3225P-425			32	25	170	25	32	50.0	4.00	25(23)	50	GCC □4000-□□	1			
R/L3225P-525			32	25	170	25	32	50.0	5.00	25(23)	50	GCC N5000-□□	1			
R/L3225P-625			32	25	170	25	32	50.0	6.00	25(23)	50	GCC N6000-□□	1			
R/L3225P-725			32	25	170	25	32	50.0	7.00	25(23)	50	GCM N7000-□□	1			
R/L3225P-825			32	25	170	25	32	50.0	8.00	25(23)	50	GCM N8000-□□	1			
GNDL R/L3232P-320	●	●	32	32	170	32	32	44.5	3.00	20(18)	40	GCC □3000-□□	1			
R/L3232P-425	●	●	32	32	170	32	32	50.0	4.00	25(23)	50	GCC □4000-□□	1			
R/L3232P-525	●	●	32	32	170	32	32	50.0	5.00	25(23)	50	GCC N5000-□□	1			
R/L3232P-625	●	●	32	32	170	32	32	50.0	6.00	25(23)	50	GCC N6000-□□	1			
R/L3232P-725	●	●	32	32	170	32	32	50.0	7.00	25(23)	50	GCM N7000-□□	1			
R/L3232P-825	●	●	32	32	170	32	32	50.0	8.00	25(23)	50	GCM N8000-□□	1			

Select holders and inserts with matching width of cut (CW). Dimensions in parentheses under maximum groove depth are for profiling inserts (RG type / RN type chipbreakers). Refer to P29 for applicable inserts. The maximum groove depth CDX is the figure during grooving. For maximum depth of cut during traverse cutting and profiling, refer to P11.



External L-Shaped (Side Cut), Grooving
Clamp-on

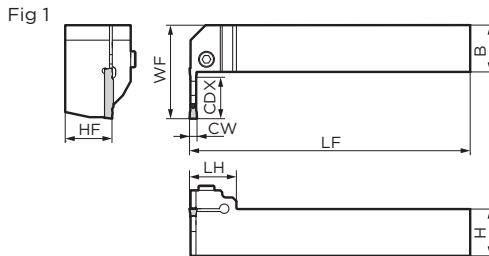
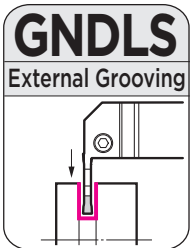

Figure shows right-handed (R) tool.

Holder

Parts

Dimensions (mm)

Cat. No.	Stock		Height H	Width B	Overall Length LF	Cutting Edge Distance WF	Cutting Edge Height HF	Head LH	Width of Cut CW	Maximum Groove Depth CDX	Applicable Insert	Fig	Cap Screw		Wrench
	R	L											BX0520	N-m	
GNDLS R/L2020K-216	●	●	20	20	125	38	20	25	2.0	16	GCC □2000-□□	1	BX0520	5.0	LH040
R/L2020K-316	●	●	20	20	125	38	20	25	3.0	16	GCC □3000-□□	1			
GNDLS R/L2525M-218	●	●	25	25	150	45	25	25	2.0	18	GCC □2000-□□	1	BX0520	5.0	LH040
R/L2525M-318	●	●	25	25	150	45	25	25	3.0	18	GCC □3000-□□	1			
R/L2525M-423	●	●	25	25	150	50	25	25	4.0	23	GCC □4000-□□	1			
R/L2525M-523	●	●	25	25	150	50	25	25	5.0	23	GCC N5000-□□	1			
R/L2525M-623	●	●	25	25	150	50	25	25	6.0	23	GCC N6000-□□	1			

Select holders and inserts with matching width of cut (CW). Refer to P29 for applicable inserts. The maximum groove depth CDX is the figure during grooving. For maximum depth of cut during traverse cutting and profiling, refer to P11.

● mark: Standard stocked item Blank: Made-to-order item (N-m) Recommended Tightening Torque (N-m)

Inserts for GNDL type/GNDLS type

Fig 1

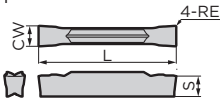
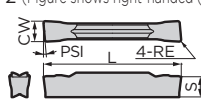

Fig 2 (Figure shows right-handed (R) tool.)



(Coated Carbide / Cermet / Cemented Carbide)

Fig 3

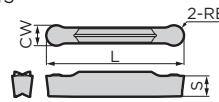
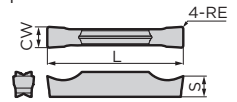

Fig 4



Grooving / Traverse Cutting

Dimensions (mm)

Cat. No.	AC8025P	AC8035P	AC830P	AC425K	AC5015S	AC5025S	AC520U	AC530U	T2500A	Width of Cut CW		Corner Radius RE	Overall Length L	Thickness S	Pcs/Pack	Fig
										Width of Cut	Tolerance					
GCM N3002-MG	●	●	●	●	●	●	●	●	—	3.0	±0.03	0.2	21.1	3.8	5	1
N3004-MG	●	●	●	●	●	●	●	●	—	3.0	±0.03	0.4	21.1	3.8	1	1
GCM N4002-MG	●	●	●	●	●	●	●	●	—	4.0	±0.03	0.2	26.4	4.0	1	1
N4004-MG	●	●	●	●	●	●	●	●	—	4.0	±0.03	0.4	26.4	4.0	1	1
N4008-MG	●	●	●	●	●	●	●	●	—	4.0	±0.03	0.8	26.4	4.0	1	1
GCM N5004-MG	●	●	●	●	●	●	●	●	—	5.0	±0.03	0.4	26.4	4.1	1	1
N5008-MG	●	●	●	●	●	●	●	●	—	5.0	±0.03	0.8	26.4	4.1	1	1
GCM N6004-MG	●	●	●	●	●	●	●	●	—	6.0	±0.03	0.4	26.4	4.5	1	1
N6008-MG	●	●	●	●	●	●	●	●	—	6.0	±0.03	0.8	26.4	4.5	1	1
GCM N7004-MG	●	●	●	●	●	●	●	●	—	7.0	±0.04	0.4	28.8	5.5	1	1
N7008-MG	●	●	●	●	●	●	●	●	—	7.0	±0.04	0.8	28.8	5.5	1	1
GCM N8004-MG	●	●	●	●	●	●	●	●	—	8.0	±0.04	0.4	28.8	6.0	1	1
N8008-MG	●	●	●	●	●	●	●	●	—	8.0	±0.04	0.8	28.8	6.0	1	1
GCM N2002-ML	—	—	—	—	—	—	—	—	—	2.0	±0.03	0.2	21.1	3.6	1	1
N3002-ML	●	●	●	●	●	●	●	●	—	3.0	±0.03	0.2	21.1	3.8	1	1
N3004-ML	●	●	●	●	●	●	●	●	—	3.0	±0.03	0.4	21.1	3.8	1	1
GCM N4002-ML	●	●	●	●	●	●	●	●	—	4.0	±0.03	0.2	26.4	4.0	1	1
N4004-ML	●	●	●	●	●	●	●	●	—	4.0	±0.03	0.4	26.4	4.0	1	1
N4008-ML	●	●	●	●	●	●	●	●	—	4.0	±0.03	0.8	26.4	4.0	1	1
GCM N5004-ML	●	●	●	●	●	●	●	●	—	5.0	±0.03	0.4	26.4	4.1	1	1
N5008-ML	●	●	●	●	●	●	●	●	—	5.0	±0.03	0.8	26.4	4.1	1	1
GCM N6004-ML	●	●	●	●	●	●	●	●	—	6.0	±0.03	0.4	26.4	4.5	1	1
N6008-ML	●	●	●	●	●	●	●	●	—	6.0	±0.03	0.8	26.4	4.5	1	1
GCM N7004-ML	●	●	●	●	●	●	●	●	—	7.0	±0.04	0.4	28.8	5.5	1	1
N7008-ML	●	●	●	●	●	●	●	●	—	7.0	±0.04	0.8	28.8	5.5	1	1
GCM N8004-ML	●	●	●	●	●	●	●	●	—	8.0	±0.04	0.4	28.8	6.0	1	1
N8008-ML	●	●	●	●	●	●	●	●	—	8.0	±0.04	0.8	28.8	6.0	1	1

Cut-off (Handed Edge)

Dimensions (mm)

Cat. No.	AC8025P	AC8035P	AC830P	AC5015S	AC5025S	AC520U	AC530U	AC1030U	Lead Angle PSI	Width of Cut CW		Corner Radius RE	Overall Length L	Thickness S	Pcs/Pack	Fig
										Width of Cut	Tolerance					
GCM R2002-CG-05	●	●	●	●	●	●	●	●	5°	2.0	±0.03	0.2	21.1	3.6	5	2
L2002-CG-05	●	●	●	●	●	●	●	●	5°	2.0	±0.03	0.2	21.1	3.6	2	2
GCM R3002-CG-05	●	●	●	●	●	●	●	●	5°	3.0	±0.03	0.2	21.3	3.8	2	2
L3002-CG-05	●	●	●	●	●	●	●	●	5°	3.0	±0.03	0.2	21.3	3.8	2	2
GCM R4002-CG-05	●	●	●	●	●	●	●	●	5°	4.0	±0.04	0.2	26.7	4.0	2	2
L4002-CG-05	●	●	●	●	●	●	●	●	5°	4.0	±0.04	0.2	26.7	4.0	2	2
GCM R20003-CF-10	—	—	—	—	—	—	—	—	10°	2.0	±0.08	0.03	22.4	3.6	5	2
L20003-CF-10	—	—	—	—	—	—	—	—	10°	2.0	±0.08	0.03	22.4	3.6	2	2
GCM R30003-CF-10	—	—	—	—	—	—	—	—	10°	3.0	±0.08	0.03	22.4	3.8	2	2
L30003-CF-10	—	—	—	—	—	—	—	—	10°	3.0	±0.08	0.03	22.4	3.8	2	2
GCM R20003-CF-15	—	—	—	—	—	—	—	—	15°	2.0	±0.08	0.03	22.4	3.6	5	2
L20003-CF-15	—	—	—	—	—	—	—	—	15°	2.0	±0.08	0.03	22.4	3.6	2	2
GCM R30003-CF-15	—	—	—	—	—	—	—	—	15°	3.0	±0.08	0.03	22.4	3.8	2	2
L30003-CF-15	—	—	—	—	—	—	—	—	15°	3.0	±0.08	0.03	22.4	3.8	2	2

GCMR: Right-handed, GCML: Left-handed

External Profiling / External Radius Grooving

Dimensions (mm)

Cat. No.	AC8025P	AC8035P	AC830P	AC425K	AC5015S	AC5025S	AC520U	AC530U	T2500A	Width of Cut CW		Corner Radius RE	Overall Length L	Thickness S	Pcs/Pack	Fig
										Width of Cut	Tolerance					
GCM N3015-RG	●	●	●	●	●	●	●	●	—	3.0	±0.03	1.5	21.1	3.8	5	3
N4020-RG	●	●	●	●	●	●	●	●	—	4.0	±0.03	2.0	26.4	4.0	3	3
GCM N5025-RG	●	●	●	●	●	●	●	●	—	5.0	±0.03	2.5	27.2	4.1	3	3
N6030-RG	●	●	●	●	●	●	●	●	—	6.0	±0.03	3.0	27.5	4.5	3	3
GCM N7035-RG	●	●	●	●	●	●	●	●	—	7.0	±0.04	3.5	29.1	5.5	3	3
N8040-RG	●	●	●	●	●	●	●	●	—	8.0	±0.04	4.0	29.3	6.0	3	3

Grooving / Cut-off

Dimensions (mm)

Cat. No.	AC8025P	AC8035P	AC830P	AC425K	AC5015S	AC5025S	AC520U	AC530U	T2500A	Width of Cut CW		Corner Radius RE	Overall Length L	Thickness S	Pcs/Pack	Fig
										Width of Cut	Tolerance					
GCM N2002-GG	●	●	●	●	●	●	●	●	—	2.0	±0.03	0.2	21.1	3.6	5	1
N3002-GG	●	●	●	●	●	●	●	●	—	3.0	±0.03	0.2	21.1	3.8	1	1
N3004-GG	●	●	●	●	●	●	●	●	—	3.0	±0.03	0.4	21.1	3.8	1	1
GCM N4002-GG	●	●	●	●	●	●	●	●	—	4.0	±0.03	0.2	26.4	4.0	1	1
N4004-GG	●	●	●	●	●	●	●	●	—	4.0	±0.03	0.4	26.4	4.0	1	1
GCM N5002-GG	●	●	●	●	●	●	●	●	—	5.0	±0.03	0.2	26.4	4.1	1	1
N5004-GG	●	●	●	●	●	●	●	●	—	5.0	±0.03	0.4	26.4	4.1	1	1
GCM N6002-GG	●	●	●	●	●	●	●	●	—	6.0	±0.03	0.2	26.4	4.5	1	1
N6004-GG	●	●	●	●	●	●	●	●	—	6.0	±0.03	0.4	26.4	4.5	1	1
GCM N7004-GG	●	●	●	●	●	●	●	●	—	7.0	±0.04	0.4	28.8	5.5	1	1
N8004-GG	●	●	●	●	●	●	●	●	—	8.0	±0.04	0.4	28.8	6.0	1	1
GCM N2002-GL	—	—	—	—	—	—	—	—	—	2.0	±0.03	0.2	21.1	3.6	1	1
N2004-GL	●	●	●	●	●	●	●	●	—	2.0	±0.03	0.4	21.1	3.6	1	1
GCM N3002-GL	●	●	●	●	●	●	●	●	—	3.0	±0.03	0.2	21.1	3.8	1	1
N3004-GL	●	●	●	●	●	●	●	●	—	3.0	±0.03	0.4	21.1	3.8	1	1
GCM N4002-GL	●	●	●	●	●	●	●	●	—	4.0	±0.03	0.2	26.4	4.0	1	1
N4004-GL	●	●	●	●	●	●	●	●	—	4.0	±0.03	0.4	26.4	4.0	1	1
GCM N5002-GL	●	●	●	●	●	●	●	●	—	5.0	±0.03	0.2	26.4	4.1	1	1
N5004-GL	●	●	●	●	●	●	●	●	—	5.0	±0.03	0.4	26.4	4.1	1	1
GCM N6002-GL	●	●	●	●	●	●	●	●	—	6.0	±0.03	0.2	26.4	4.5	1	1
N6004-GL	●	●	●	●	●	●	●	●	—	6.0	±0.03	0.4	26.4	4.5	1	1
GCM N7004-GL	●	●	●	●	●	●	●	●	—	7.0	±0.04	0.4	28.8	5.5	1	1
N8004-GL	●	●	●	●	●	●	●	●	—	8.0	±0.04	0.4	28.8	6.0	1	1
GCM N125005-GF	—	—	—	—	—	—	—	—	—	1.25	±0.03	0.05	17.4	3.2	1	1
N150005-GF	—	—	—	—	—	—	—	—	—	1.5	±0.03	0.05	17.8	3.7	1	1
GCM N2002-GF	●	●	●	●	●	●	●	●	—	2.0	±0.03	0.2	21.1	3.6	1	1
N2004-GF	●	●	●	●	●	●	●	●	—	2.0	±0.03	0.4	21.1	3.6	1	1
GCM N3002-GF	●	●	●	●	●	●	●	●	—	3.0	±0.03	0.2	21.1	3.8	1	1
N3004-GF	●	●	●	●	●	●	●	●	—	3.0	±0.03	0.4	21.1	3.8	1	1
GCM N4002-GF	●	●	●	●	●	●	●	●	—	4.0	±0.03	0.2	26.4	4.0	1	1
N4004-GF	●	●	●	●	●	●	●	●	—	4.0	±0.03	0.4	26.4	4.0	1	1
GCM N5002-GF	●	●	●	●	●	●	●	●	—	5.0	±0.03	0.2	26.4	4.1	1	1
N5004-GF	●	●	●	●	●	●	●	●	—	5.0	±0.03	0.4	26.4	4.1	1	1
GCM N6002-GF	●	●	●	●	●											



External Deep Grooving and Cut-off
Internal Coolant Supply, Clamp-on

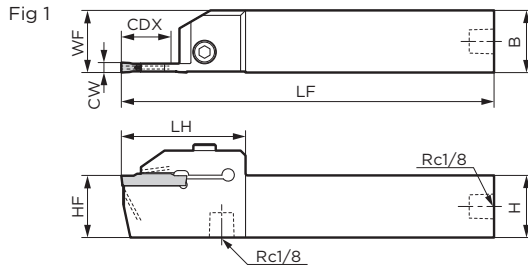
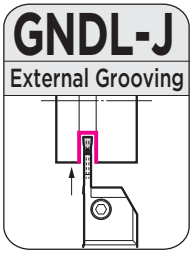

Figure shows right-handed (R) tool.

Holder

Parts

Dimensions (mm)

Cat. No.	Stock		Height H	Width B	Overall Length LF	Cutting Edge Distance WF	Cutting Edge Height HF	Head LH	Width of Cut CW	Maximum Groove Depth CDX	Max. Cut-off Dia.	Applicable Insert	Fig	Dimensions (mm)			
	R	L												Cap Screw	Plug	Wrench	
GNDL R/L2020K-220J	●	●	20	20	125	20	20	44.5	2.00	20(18)	40	GC □ 2000-□ □	1	BX0520	6.0	XP02	LH040
R/L2020K-320J	●	●	20	20	125	20	20	44.5	3.00	20(18)	40	GC □ 3000-□ □	1				
R/L2020K-425J	●	●	20	20	125	20	20	50	4.00	25(23)	50	GC □ 4000-□ □	1				
R/L2020K-525J	●	●	20	20	125	20	20	50	5.00	25(23)	50	GC □ N5000-□ □	1				
R/L2020K-625J	●	●	20	20	125	20	20	50	6.00	25(23)	50	GC □ N6000-□ □	1				
GNDL R/L2525K-220J	●	●	25	25	125	25	25	44.5	2.00	20(18)	40	GC □ 2000-□ □	1	BX0520	6.0	XP02	LH040
R/L2525K-320J	●	●	25	25	125	25	25	44.5	3.00	20(18)	40	GC □ 3000-□ □	1				
R/L2525K-425J	●	●	25	25	125	25	25	50	4.00	25(23)	50	GC □ 4000-□ □	1				
R/L2525K-525J	●	●	25	25	125	25	25	50	5.00	25(23)	50	GC □ N5000-□ □	1				
R/L2525K-625J	●	●	25	25	125	25	25	50	6.00	25(23)	50	GC □ N6000-□ □	1				

Select holders and inserts with matching width of cut (CW). Dimensions in parentheses under maximum groove depth are for profiling inserts (RG type / RN type chipbreakers). Refer to P31 for applicable inserts.

The maximum groove depth CDX is the figure during grooving. For maximum depth of cut during traverse cutting and profiling, refer to P11.

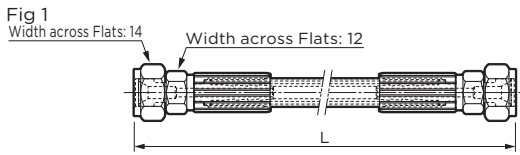

Parts (Hose)

Dimensions (mm)

Cat. No.	Stock	L	Screw Standard	Screw Standard	Fig
J-HOSE-G1/8-G1/8-200	●	200	G1/8	G1/8	1
J-HOSE-G1/8-G1/8-300	●	300	G1/8	G1/8	1

Hoses are sold separately.

Piping Method for Hoses and Connectors **P15**

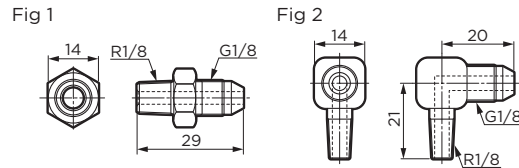

Parts (Connector)

Dimensions (mm)

Cat. No.	Stock	Screw Standard	Screw Standard	Fig
J-G1/8-R1/8-00	●	G1/8	R1/8	1
J-G1/8-R1/8-90	●	G1/8	R1/8	2

Connectors are sold separately.

Piping Method for Hoses and Connectors **P15**

Inserts for GNDL-J type

Fig 1

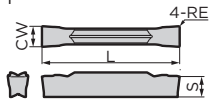
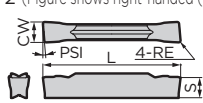

Fig 2 (Figure shows right-handed (R) tool.)



(Coated Carbide / Cermet / Cemented Carbide)

Fig 3

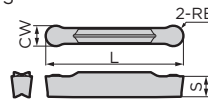
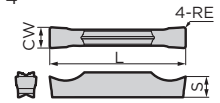

Fig 4



Grooving / Traverse Cutting

Dimensions (mm)

Cat. No.	AC8025P	AC8035P	AC830P	AC425K	AC5015S	AC5025S	AC520U	AC530U	T2500A	Width of Cut CW		Corner Radius RE	Overall Length L	Thickness S	Pcs/Pack	Fig
										Width of Cut	Tolerance					
GCM N3002-MG	●	●	●	●	●	●	●	●	●	3.0	±0.03	0.2	21.1	3.8	1	
N3004-MG	●	●	●	●	●	●	●	●	●	3.0	±0.03	0.4	21.1	3.8	1	
GCM N4002-MG	●	●	●	●	●	●	●	●	●	4.0	±0.03	0.2	26.4	4.0	1	
N4004-MG	●	●	●	●	●	●	●	●	●	4.0	±0.03	0.4	26.4	4.0	1	
N4008-MG	●	●	●	●	●	●	●	●	●	4.0	±0.03	0.8	26.4	4.0	5	
GCM N5004-MG	●	●	●	●	●	●	●	●	●	5.0	±0.03	0.4	26.4	4.1	1	
N5008-MG	●	●	●	●	●	●	●	●	●	5.0	±0.03	0.8	26.4	4.1	1	
GCM N6004-MG	●	●	●	●	●	●	●	●	●	6.0	±0.03	0.4	26.4	4.5	1	
N6008-MG	●	●	●	●	●	●	●	●	●	6.0	±0.03	0.8	26.4	4.5	1	
GCM N2002-ML	●	●	●	●	●	●	●	●	●	2.0	±0.03	0.2	21.1	3.6	1	
N3002-ML	●	●	●	●	●	●	●	●	●	3.0	±0.03	0.2	21.1	3.8	1	
N3004-ML	●	●	●	●	●	●	●	●	●	3.0	±0.03	0.4	21.1	3.8	1	
GCM N4002-ML	●	●	●	●	●	●	●	●	●	4.0	±0.03	0.2	26.4	4.0	1	
N4004-ML	●	●	●	●	●	●	●	●	●	4.0	±0.03	0.4	26.4	4.0	1	
N4008-ML	●	●	●	●	●	●	●	●	●	4.0	±0.03	0.8	26.4	4.0	5	
GCM N5004-ML	●	●	●	●	●	●	●	●	●	5.0	±0.03	0.4	26.4	4.1	1	
N5008-ML	●	●	●	●	●	●	●	●	●	5.0	±0.03	0.8	26.4	4.1	1	
GCM N6004-ML	●	●	●	●	●	●	●	●	●	6.0	±0.03	0.4	26.4	4.5	1	
N6008-ML	●	●	●	●	●	●	●	●	●	6.0	±0.03	0.8	26.4	4.5	1	

Grooving / Cut-off

Dimensions (mm)

Cat. No.	AC8025P	AC8035P	AC830P	AC425K	AC5015S	AC5025S	AC520U	AC530U	T2500A	Width of Cut CW		Corner Radius RE	Overall Length L	Thickness S	Pcs/Pack	Fig
										Width of Cut	Tolerance					
GCM N2002-GG	●	●	●	●	●	●	●	●	●	2.0	±0.03	0.2	21.1	3.6	1	
GCM N3002-GG	●	●	●	●	●	●	●	●	●	3.0	±0.03	0.2	21.1	3.8	1	
N3004-GG	●	●	●	●	●	●	●	●	●	3.0	±0.03	0.4	21.1	3.8	1	
GCM N4002-GG	●	●	●	●	●	●	●	●	●	4.0	±0.03	0.2	26.4	4.0	1	
N4004-GG	●	●	●	●	●	●	●	●	●	4.0	±0.03	0.4	26.4	4.0	5	
GCM N5002-GG	●	●	●	●	●	●	●	●	●	5.0	±0.03	0.2	26.4	4.1	1	
N5004-GG	●	●	●	●	●	●	●	●	●	5.0	±0.03	0.4	26.4	4.1	1	
GCM N6002-GG	●	●	●	●	●	●	●	●	●	6.0	±0.03	0.2	26.4	4.5	1	
N6004-GG	●	●	●	●	●	●	●	●	●	6.0	±0.03	0.4	26.4	4.5	1	
GCM N2002-GL	●	●	●	●	●	●	●	●	●	2.0	±0.03	0.2	21.1	3.6	1	
N2004-GL	●	●	●	●	●	●	●	●	●	2.0	±0.03	0.4	21.1	3.6	1	
GCM N3002-GL	●	●	●	●	●	●	●	●	●	3.0	±0.03	0.2	21.1	3.8	1	
N3004-GL	●	●	●	●	●	●	●	●	●	3.0	±0.03	0.4	21.1	3.8	1	
GCM N4002-GL	●	●	●	●	●	●	●	●	●	4.0	±0.03	0.2	26.4	4.0	1	
N4004-GL	●	●	●	●	●	●	●	●	●	4.0	±0.03	0.4	26.4	4.0	5	
GCM N5002-GL	●	●	●	●	●	●	●	●	●	5.0	±0.03	0.2	26.4	4.1	1	
N5004-GL	●	●	●	●	●	●	●	●	●	5.0	±0.03	0.4	26.4	4.1	1	
GCM N6002-GL	●	●	●	●	●	●	●	●	●	6.0	±0.03	0.2	26.4	4.5	1	
N6004-GL	●	●	●	●	●	●	●	●	●	6.0	±0.03	0.4	26.4	4.5	1	
GCM N125005-GF	●	●	●	●	●	●	●	●	●	1.25	±0.03	0.05	17.4	3.2	1	
GCM N150005-GF	●	●	●	●	●	●	●	●	●	1.5	±0.03	0.05	17.8	3.7	1	
GCM N2002-GF	●	●	●	●	●	●	●	●	●	2.0	±0.03	0.2	21.1	3.6	1	
N2004-GF	●	●	●	●	●	●	●	●	●	2.0	±0.03	0.4	21.1	3.6	1	
GCM N3002-GF	●	●	●	●	●	●	●	●	●	3.0	±0.03	0.2	21.1	3.8	1	
N3004-GF	●	●	●	●	●	●	●	●	●	3.0	±0.03	0.4	21.1	3.8	1	
GCM N4002-GF	●	●	●	●	●	●	●	●	●	4.0	±0.03	0.2	26.4	4.0	1	
N4004-GF	●	●	●	●	●	●	●	●	●	4.0	±0.03	0.4	26.4	4.0	1	
GCM N5002-GF	●	●	●	●	●	●	●	●	●	5.0	±0.03	0.2	26.4	4.1	1	
N5004-GF	●	●	●	●	●	●	●	●	●	5.0	±0.03	0.4	26.4	4.1	1	
GCM N6002-GF	●	●	●	●	●	●	●	●	●	6.0	±0.03	0.2	26.4	4.5	1	
N6004-GF	●	●	●	●	●	●	●	●	●	6.0	±0.03	0.4	26.4	4.5	1	

Cut-off (Handed Edge)

Dimensions (mm)

Cat. No.	AC8025P	AC8035P	AC830P	AC5015S	AC5025S	AC520U	AC530U	AC1030U	Lead Angle PSI	Width of Cut CW		Corner Radius RE	Overall Length L	Thickness S	Pcs/Pack	Fig
										Width of Cut	Tolerance					
GCM R2002-CG-05	●	●	●	●	●	●	●	●	5°	2.0	±0.03	0.2	21.1	3.6	2	
L2002-CG-05	●	●	●	●	●	●	●	●	5°	2.0	±0.03	0.2	21.1	3.6	2	
GCM R3002-CG-05	●	●	●	●	●	●	●	●	5°	3.0	±0.03	0.2	21.3	3.8	2	
L3002-CG-05	●	●	●	●	●	●	●	●	5°	3.0	±0.03	0.2	21.3	3.8	2	
GCM R4002-CG-05	●	●	●	●	●	●	●	●	5°	4.0	±0.04	0.2	26.7	4.0	2	
L4002-CG-05	●	●	●	●	●	●	●	●	5°	4.0	±0.04	0.2	26.7	4.0	2	
GCM R20003-CF-10	●	●	●	●	●	●	●	●	10°	2.0	±0.08	0.03	22.4	3.6	2	
L20003-CF-10	●	●	●	●	●	●	●	●	10°	2.0	±0.08	0.03	22.4	3.6	2	
GCM R30003-CF-10	●	●	●	●	●	●	●	●	10°	3.0	±0.08	0.03	22.4	3.8	2	
L30003-CF-10	●	●	●	●	●	●	●	●	10°	3.0	±0.08	0.03	22.4	3.8	2	
GCM R20003-CF-15	●	●	●	●	●	●	●	●	15°	2.0	±0.08	0.03	22.4	3.6	2	
L20003-CF-15	●	●	●	●	●	●	●	●	15°	2.0	±0.08	0.03	22.4	3.6	2	
GCM R30003-CF-15	●	●	●	●	●	●	●	●	15°	3.0	±0.08	0.03	22.4	3.8	2	
L30003-CF-15	●	●	●	●	●	●	●	●	15°	3.0	±0.08	0.03	22.4	3.8	2	

GCMR: Right-handed, GCMCL: Left-handed

External Profiling / External Radius Grooving

Dimensions (mm)

Cat. No.	AC8025P	AC8035P	AC830P	AC425K	AC5015S	AC5025S	AC520U	AC530U	T2500A	Width of Cut CW		Corner Radius RE	Overall Length L	Thickness S	Pcs/Pack	Fig
										Width of Cut	Tolerance					
GCM N3015-RG	●	●	●	●	●	●	●	●	●	3.0	±0.03	1.5	21.1	3.8	3	
N4020-RG	●	●	●	●	●	●	●	●	●	4.0	±0.03	2.0	26.4	4.0	3	
GCM N5025-RG	●	●	●	●	●	●	●	●	●	5.0	±0.03	2.5	27.2	4.1	3	
N6030-RG	●	●	●	●	●	●	●	●	●	6.0	±0.03	3.0	27.5	4.5	3	

Profiling / Radius Grooving / Necking

Dimensions (mm)

Cat. No.	AC8025P	AC8035P	AC830P	AC425K	AC5015S	AC5025S	AC520U	AC530U	Width of Cut CW		Corner Radius RE	Overall Length L	Thickness S	Pcs/Pack	Fig
									Width of Cut	Tolerance					
GCM N2010-RN	●	●	●	●	●	●	●	●	2.0	±0.03	1.0	21.7	3.6	3	
N3015-RN	●	●	●	●	●	●	●	●	3.0	±0.03	1.5	22.6	3.8	3	
N4020-RN	●	●	●	●	●	●	●	●	4.0	±0.03	2.0	28.2	4.0	5	
N5025-RN	●	●	●	●	●	●	●	●	5.0	±0.03	2.5	28.3	4.1	3	
N6030-RN	●	●	●	●	●	●	●	●	6.0	±0.03	3.0	28.3	4.5	3	

Non-Ferrous Metals

Dimensions (mm)

Cat. No.	HT0	Width of Cut CW		Corner Radius RE	Overall Length L	Thickness S	Pcs/Pack	Fig
		Width of Cut	Tolerance					
GCG N2002-GA	●	2.0	±0.025	0.2	21.1	3.6	4	
N3002-GA	●	3.0	±0.025	0.2	21.1	3.8	4	
GCG N4004-GA	●	4.0	±0.025	0.4	26.4	4.0	5	
N5004-GA	●	5.0	±0.025	0.4	26.4	4.1	4	
N6004-GA	●	6.0	±0.025	0.4	26.4	4.5	4	

Part Number Suffix Code (Chipbreakers)

Type	Symbol	Applications	Type	Symbol	Applications
Grooving / Traverse Cutting	MG	Multi-functional / General-purpose	Cut-off (Handed Edge)	CG	Cut-off / General-purpose
	ML	Multi-functional / Low-feed		CF	Cut-off / Low cutting force
Grooving / Cut-off	GG	Grooving /			



External Deep Grooving and Cut-off
 Clamp-on

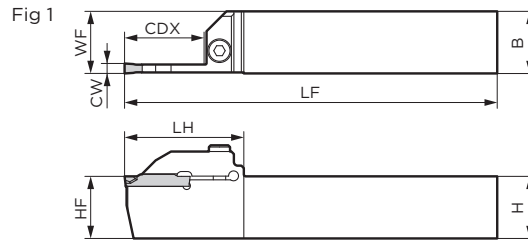
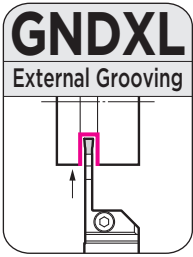

Figure shows right-handed (R) tool.

Holder

Parts

Dimensions (mm)

Cat. No.	Stock		Height H	Width B	Overall Length LF	Cutting Edge Distance WF	Cutting Edge Height HF	Head LH	Width of Cut CW	Maximum Groove Depth CDX	Max. Cut-off Dia.	Applicable Insert	Fig	Cap Screw		Wrench
	R	L												Cap Screw	N·m	
GNDXL R/L2020K-226			20	20	125	20	20	42.0	2.0	26	52	GCM N2002-GF1	1			
R/L2020K-332	●	●	20	20	125	20	20	48.0	3.0	32	64	GCM N3000-□□1	1			
R/L2020K-432	●	●	20	20	125	20	20	48.0	4.0	32	64	GCM N4000-□□1	1	BX0520	5.0	LH040
R/L2020K-532	●	●	20	20	125	20	20	48.0	5.0	32	64	GCM N5000-□□1	1			
R/L2020K-632	●	●	20	20	125	20	20	48.0	6.0	32	64	GCM N6000-□□1	1			
GNDXL R/L2525M-226			25	25	150	25	25	42.0	2.0	26	52	GCM N2002-GF1	1			
R/L2525M-332	●	●	25	25	150	25	25	48.0	3.0	32	64	GCM N3000-□□1	1			
R/L2525M-432	●	●	25	25	150	25	25	48.0	4.0	32	64	GCM N4000-□□1	1	BX0520	5.0	LH040
R/L2525M-532	●	●	25	25	150	25	25	48.0	5.0	32	64	GCM N5000-□□1	1			
R/L2525M-632	●	●	25	25	150	25	25	48.0	6.0	32	64	GCM N6000-□□1	1			

Select holders and inserts with matching width of cut (CW). **Only 1-cornered inserts can be used.** Refer to P33 for applicable inserts.
 The maximum groove depth CDX is the figure during grooving. For maximum depth of cut during traverse cutting and profiling, refer to P11.



Inserts for GNDXL type (1-cornered)

(Coated Carbide)

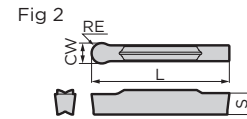
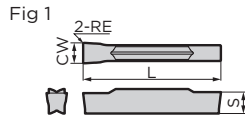

Grooving / Traverse Cutting (1-cornered)

Dimensions (mm)

Cat. No.	AC5015S	AC5025S	AC530U	Width of Cut CW		Corner Radius RE	Overall Length L	Thickness S	Pcs/Pack	Fig
				Width of Cut	Tolerance					
GCM N3002-ML1	●	●	●	3.0	±0.03	0.2	21.1	3.8	5	1
N4004-ML1	●	●	●	4.0	±0.03	0.4	26.4	4.0		1
N5004-ML1	●	●	●	5.0	±0.03	0.4	26.4	4.1		1
N6004-ML1	●	●	●	6.0	±0.03	0.4	26.4	4.5		1

Profiling / Radius Grooving (1-cornered)

Dimensions (mm)

Cat. No.	AC5015S	AC5025S	AC530U	Width of Cut CW		Corner Radius RE	Overall Length L	Thickness S	Pcs/Pack	Fig
				Width of Cut	Tolerance					
GCM N3015-RN1	●	●	●	3.0	±0.03	1.5	22.6	3.8	5	2
N6030-RN1	●	●	●	6.0	±0.03	3.0	28.3	4.5		2

Grooving / Cut-off (1-cornered)

Dimensions (mm)

Cat. No.	AC5015S	AC5025S	AC530U	Width of Cut CW		Corner Radius RE	Overall Length L	Thickness S	Pcs/Pack	Fig
				Width of Cut	Tolerance					
GCM N2002-GF1	●	●	●	2.0	±0.03	0.2	21.1	3.6	5	1
N3002-GF1	●	●	●	3.0	±0.03	0.2	21.1	3.8		1
N4002-GF1	●	●	●	4.0	±0.03	0.2	26.4	4.0		1
N5002-GF1	●	●	●	5.0	±0.03	0.2	26.4	4.1		1
N6002-GF1	●	●	●	6.0	±0.03	0.2	26.4	4.5		1

Select holders and inserts with matching width of cut (CW). Use in combination with GNDXL type holders. Not usable with GNDIS type holders.

Part Number Suffix Code (Chipbreakers)

Type	Symbol	Applications	Type	Symbol	Applications
Grooving / Traverse Cutting	ML1	Multi-functional / Low-feed	Profiling / Radius Grooving	RN1	General-purpose
Grooving / Cut-off	GF1	Grooving / Low cutting force			

Chipbreaker Selection **P5** Recommended Cutting Conditions **P11** Precautions for Use **P14**

● mark: Standard stocked item (new product/expanded item) Blank: Made-to-order item



Necking
 Clamp-on

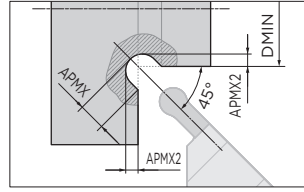
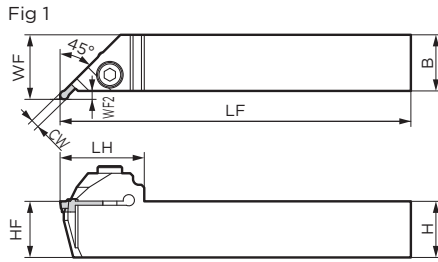
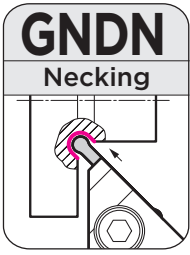

Figure shows right-handed (R) tool.

Holder

Parts Dimensions (mm)

Cat. No.	Stock		Height	Width	Overall Length	Cutting Edge Distance	Cutting Edge Height	Head	Offset	Min. Bore Dia.	Width of Cut	APMX	APMX2	Applicable Insert	Fig	Parts		
	R	L														Cap Screw	Wrench	
GNDN R/L2020K-215-020	●	●	20	20	125	23	20	35	3.0	20	2.0	1.5	0.64	GCM N2010-RN	1	BX0520	5.0	LH040
R/L2020K-320-020	●	●	20	20	125	23	20	35	3.0	20	3.0	2.0	0.79	GCM N3015-RN	1			
R/L2020K-430-030	●	●	20	20	125	24	20	37	4.0	30	4.0	3.0	1.29	GCM N4020-RN	1			
R/L2020K-535-030	●	●	20	20	125	25	20	40	5.0	30	5.0	3.5	1.44	GCM N5025-RN	1			
R/L2020K-640-030	●	●	20	20	125	25	20	40	5.0	30	6.0	4.0	1.59	GCM N6030-RN	1			
GNDN R/L2525M-215-020	●	●	25	25	150	28	25	35	3.0	20	2.0	1.5	0.64	GCM N2010-RN	1	BX0520	5.0	LH040
R/L2525M-320-020	●	●	25	25	150	28	25	35	3.0	20	3.0	2.0	0.79	GCM N3015-RN	1			
R/L2525M-430-030	●	●	25	25	150	29	25	37	4.0	30	4.0	3.0	1.29	GCM N4020-RN	1			
R/L2525M-535-030	●	●	25	25	150	30	25	40	5.0	30	5.0	3.5	1.44	GCM N5025-RN	1			
R/L2525M-640-030	●	●	25	25	150	30	25	40	5.0	30	6.0	4.0	1.59	GCM N6030-RN	1			

Select holders and inserts with matching width of cut (CW). Refer to P35 for applicable inserts.

The maximum groove depth CDX is the figure during grooving. For maximum depth of cut during traverse cutting and profiling, refer to P11.

Inserts for GNDN type

( Coated Carbide)

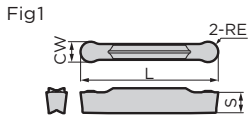

Profiling / Radius Grooving / Necking Dimensions (mm)

Cat. No.	AC8025P	AC8035P	AC830P	AC425K	AC5015S	AC5025S	AC520U	AC530U	Width of Cut CW		Corner Radius RE	Overall Length L	Thickness S	Pcs/Pack	Fig
									Width of Cut	Tolerance					
									GCM N2010-RN	—	—	—	—	●	●
N3015-RN	●	●	●	●	●	●	●	●	3.0	±0.03	1.5	22.6	3.8	5	1
N4020-RN	●	●	●	●	●	●	●	●	4.0	±0.03	2.0	28.2	4.0	5	1
N5025-RN	●	●	●	●	●	●	●	●	5.0	±0.03	2.5	28.3	4.1	5	1
N6030-RN	●	●	●	●	●	●	●	●	6.0	±0.03	3.0	28.3	4.5	5	1

Guides
 External Dia.
 Face
 Internal Dia.
Necking
 SumiPolygon
 Request Form
 Application Examples

Part Number Suffix Code (Chipbreakers)

Type	Symbol	Applications
Profiling / Radius Grooving / Necking	RN	Facing / Necking / General-purpose

Chipbreaker Selection  **P5** Recommended Cutting Conditions  **P11** Precautions for Use  **P14**

Select holders and inserts with matching width of cut (CW). Not usable with GNDXL type / GNDIS type holders.

● mark: Standard stocked item —mark: Not available



* For traverse cutting (groove expansion), use a multi-functional or profiling insert.

Face Grooving
Clamp-on

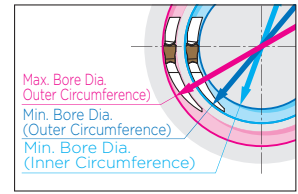
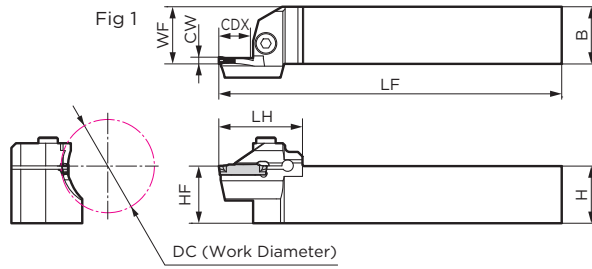
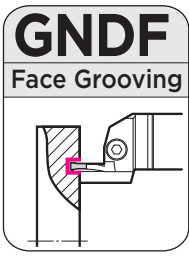

Figure shows right-handed (R) tool.

Holder

Parts Dimensions (mm)

Cat. No.	Stock		Height H	Width B	Overall Length LF	Cutting Edge Distance WF	Cutting Edge Height HF	Head LH	Machining diameter DC	Min. Bore Dia. Inner Circumference	Width of Cut CW	Maximum Groove Depth CDX	Applicable Insert	Fig	Cap Screw			Wrench				
	R	L																				
GND R/L2020K-312-035	●	●	20	20	125	20	20	35.6	35 to 45	29	3.0	12	GC □ N3000-□□	1	BX0520	5.0	LH040					
R/L2020K-312-040	●	●	20	20	125	20	20	35.6	40 to 55	34	3.0	12										
R/L2020K-318-050	●	●	20	20	125	20	20	41.6	50 to 70	44	3.0	18										
R/L2020K-318-065	●	●	20	20	125	20	20	41.6	65 to 100	59	3.0	18										
R/L2020K-318-090	●	●	20	20	125	20	20	41.6	90 to 150	84	3.0	18										
R/L2020K-318-140	●	●	20	20	125	20	20	41.6	140 to 200	134	3.0	18										
R/L2020K-318-180	●	●	20	20	125	20	20	41.6	180 to 300	174	3.0	18										
GND R/L2020K-418-040	●	●	20	20	125	20	20	41.6	40 to 55	32	4.0	18	GC □ N4000-□□	1	BX0520	5.0	LH040					
R/L2020K-423-050	●	●	20	20	125	20	20	46.6	50 to 70	42	4.0	23										
R/L2020K-423-065	●	●	20	20	125	20	20	46.6	65 to 90	57	4.0	23										
R/L2020K-423-085	●	●	20	20	125	20	20	46.6	85 to 130	77	4.0	23										
R/L2020K-423-125	●	●	20	20	125	20	20	46.6	125 to 200	117	4.0	23										
R/L2020K-423-180	●	●	20	20	125	20	20	46.6	180 to 300	172	4.0	23										
R/L2020K-423-280	●	●	20	20	125	20	20	46.6	280 to 1000	272	4.0	23										
GND R/L2020K-523-050	●	●	20	20	125	20	20	46.6	50 to 70	40	5.0	23	GC □ N5000-□□	1	BX0520	5.0	LH040					
R/L2020K-523-065	●	●	20	20	125	20	20	46.6	65 to 90	55	5.0	23										
R/L2020K-523-085	●	●	20	20	125	20	20	46.6	85 to 130	75	5.0	23										
R/L2020K-523-125	●	●	20	20	125	20	20	46.6	125 to 200	115	5.0	23										
R/L2020K-523-180	●	●	20	20	125	20	20	46.6	180 to 300	170	5.0	23										
R/L2020K-523-280	●	●	20	20	125	20	20	46.6	280 to 1000	270	5.0	23										
GND R/L2020K-623-050	●	●	20	20	125	20	20	46.6	50 to 75	38	6.0	23						GC □ N6000-□□	1	BX0520	5.0	LH040
R/L2020K-623-070	●	●	20	20	125	20	20	46.6	70 to 110	58	6.0	23										
R/L2020K-623-100	●	●	20	20	125	20	20	46.6	100 to 200	88	6.0	23										
R/L2020K-623-180	●	●	20	20	125	20	20	46.6	180 to 300	168	6.0	23										
R/L2020K-623-280	●	●	20	20	125	20	20	46.6	280 to 1000	268	6.0	23										
GND R/L2525M-312-035	●	●	25	25	150	25	25	35.6	35 to 45	29	3.0	12	GC □ N3000-□□	1	BX0520	5.0	LH040					
R/L2525M-312-040	●	●	25	25	150	25	25	35.6	40 to 55	34	3.0	12										
R/L2525M-318-050	●	●	25	25	150	25	25	41.6	50 to 70	44	3.0	18										
R/L2525M-318-065	●	●	25	25	150	25	25	41.6	65 to 100	59	3.0	18										
R/L2525M-318-090	●	●	25	25	150	25	25	41.6	90 to 150	84	3.0	18										
R/L2525M-318-140	●	●	25	25	150	25	25	41.6	140 to 200	134	3.0	18										
R/L2525M-318-180	●	●	25	25	150	25	25	41.6	180 to 300	174	3.0	18										
GND R/L2525M-418-040	●	●	25	25	150	25	25	41.6	40 to 55	32	4.0	18	GC □ N4000-□□	1	BX0520	5.0	LH040					
R/L2525M-423-050	●	●	25	25	150	25	25	46.6	50 to 70	42	4.0	23										
R/L2525M-423-065	●	●	25	25	150	25	25	46.6	65 to 90	57	4.0	23										
R/L2525M-423-085	●	●	25	25	150	25	25	46.6	85 to 130	77	4.0	23										
R/L2525M-423-125	●	●	25	25	150	25	25	46.6	125 to 200	117	4.0	23										
R/L2525M-423-180	●	●	25	25	150	25	25	46.6	180 to 300	172	4.0	23										
R/L2525M-423-280	●	●	25	25	150	25	25	46.6	280 to 1000	272	4.0	23										
GND R/L2525M-523-050	●	●	25	25	150	25	25	46.6	50 to 70	40	5.0	23	GC □ N5000-□□	1	BX0520	5.0	LH040					
R/L2525M-523-065	●	●	25	25	150	25	25	46.6	65 to 90	55	5.0	23										
R/L2525M-523-085	●	●	25	25	150	25	25	46.6	85 to 130	75	5.0	23										
R/L2525M-523-125	●	●	25	25	150	25	25	46.6	125 to 200	115	5.0	23										
R/L2525M-523-180	●	●	25	25	150	25	25	46.6	180 to 300	170	5.0	23										
R/L2525M-523-280	●	●	25	25	150	25	25	46.6	280 to 1000	270	5.0	23										
GND R/L2525M-623-050	●	●	25	25	150	25	25	46.6	50 to 75	38	6.0	23						GC □ N6000-□□	1	BX0520	5.0	LH040
R/L2525M-623-070	●	●	25	25	150	25	25	46.6	70 to 110	58	6.0	23										
R/L2525M-623-100	●	●	25	25	150	25	25	46.6	100 to 200	88	6.0	23										
R/L2525M-623-180	●	●	25	25	150	25	25	46.6	180 to 300	168	6.0	23										
R/L2525M-623-280	●	●	25	25	150	25	25	46.6	280 to 1000	268	6.0	23										

Select holders and inserts with matching width of cut (CW). Refer to P37 for applicable inserts.

The maximum groove depth CDX is the figure during grooving. For maximum depth of cut during traverse cutting and profiling, refer to P11.

● mark: Standard stocked item Recommended Tightening Torque (N-m)

Inserts for GNDF type

(Coated Carbide / Cermet / Cemented Carbide)

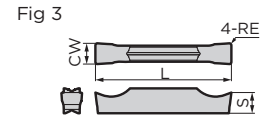
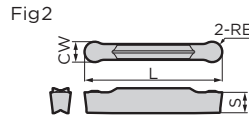
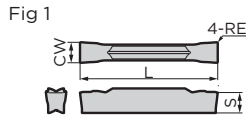

Grooving / Traverse Cutting

Dimensions (mm)

Cat. No.	AC8025P	AC8035P	AC830P	AC425K	AC5015S	AC5025S	AC520U	AC530U	T2500A	Width of Cut CW				Pcs/Pack	Fig	
										Width of Cut		RE	L			S
										Width of Cut	Tolerance					
GCM N3002-MG	●	●	●	●	●	●	●	●	●	3.0	±0.03	0.2	21.1	3.8	5	1
N3004-MG	●	●	●	●	●	●	●	●	●	3.0	±0.03	0.4	21.1	3.8		
GCM N4002-MG	●	●	●	●	●	●	●	●	●	4.0	±0.03	0.2	26.4	4.0	5	1
N4004-MG	●	●	●	●	●	●	●	●	●	4.0	±0.03	0.4	26.4	4.0		
GCM N4008-MG	●	●	●	●	●	●	●	●	●	4.0	±0.03	0.8	26.4	4.0	5	1
GCM N5004-MG	●	●	●	●	●	●	●	●	●	5.0	±0.03	0.4	26.4	4.1		
N5008-MG	●	●	●	●	●	●	●	●	●	5.0	±0.03	0.8	26.4	4.1	5	1
GCM N6004-MG	●	●	●	●	●	●	●	●	●	6.0	±0.03	0.4	26.4	4.5		
N6008-MG	●	●	●	●	●	●	●	●	●	6.0	±0.03	0.8	26.4	4.5	5	1
GCM N3002-ML	●	●	●	●	●	●	●	●	●	3.0	±0.03	0.2	21.1	3.8		
N3004-ML	●	●	●	●	●	●	●	●	●	3.0	±0.03	0.4	21.1	3.8	5	1
GCM N4002-ML	●	●	●	●	●	●	●	●	●	4.0	±0.03	0.2	26.4	4.0		
N4004-ML	●	●	●	●	●	●	●	●	●	4.0	±0.03	0.4	26.4	4.0	5	1
N4008-ML	●	●	●	●	●	●	●	●	●	4.0	±0.03	0.8	26.4	4.0		
GCM N5004-ML	●	●	●	●	●	●	●	●	●	5.0	±0.03	0.4	26.4	4.1	5	1
N5008-ML	●	●	●	●	●	●	●	●	●	5.0	±0.03	0.8	26.4	4.1		
GCM N6004-ML	●	●	●	●	●	●	●	●	●	6.0	±0.03	0.4	26.4	4.5	5	1
N6008-ML	●	●	●	●	●	●	●	●	●	6.0	±0.03	0.8	26.4	4.5		

Profiling / Radius Grooving / Necking

Dimensions (mm)

Cat. No.	AC8025P	AC8035P	AC830P	AC425K	AC5015S	AC5025S	AC520U	AC530U	Width of Cut CW				Pcs/Pack	Fig		
									Width of Cut		RE	L			S	
									Width of Cut	Tolerance						
GCM N3015-RN	●	●	●	●	●	●	●	●	●	3.0	±0.03	1.5	22.6	3.8	5	2
N4020-RN	●	●	●	●	●	●	●	●	●	4.0	±0.03	2.0	28.2	4.0		
N5025-RN	●	●	●	●	●	●	●	●	●	5.0	±0.03	2.5	28.3	4.1	5	2
N6030-RN	●	●	●	●	●	●	●	●	●	6.0	±0.03	3.0	28.3	4.5		

Non-Ferrous Metals

Dimensions (mm)

Cat. No.	H10	Width of Cut CW				Pcs/Pack	Fig					
		Width of Cut		RE	L			S				
		Width of Cut	Tolerance									
GCG N3002-GA	●					3.0	±0.025	0.2	21.1	3.8	5	3
GCG N4004-GA	●					4.0	±0.025	0.4	26.4	4.0		
N5004-GA	●					5.0	±0.025	0.4	26.4	4.1	5	3
N6004-GA	●					6.0	±0.025	0.4	26.4	4.5		

Grooving / Cut-off

Dimensions (mm)

Cat. No.	AC8025P	AC8035P	AC830P	AC425K	AC5015S	AC5025S	AC520U	AC530U	T2500A	Width of Cut CW				Pcs/Pack	Fig	
										Width of Cut		RE	L			S
										Width of Cut	Tolerance					
GCM N3002-GG	●	●	●	●	●	●	●	●	●	3.0	±0.03	0.2	21.1	3.8	5	1
N3004-GG	●	●	●	●	●	●	●	●	●	3.0	±0.03	0.4	21.1	3.8		
GCM N4002-GG	●	●	●	●	●	●	●	●	●	4.0	±0.03	0.2	26.4	4.0	5	1
N4004-GG	●	●	●	●	●	●	●	●	●	4.0	±0.03	0.4	26.4	4.0		
GCM N5002-GG	●	●	●	●	●	●	●	●	●	5.0	±0.03	0.2	26.4	4.1	5	1
N5004-GG	●	●	●	●	●	●	●	●	●	5.0	±0.03	0.4	26.4	4.1		
GCM N6002-GG	●	●	●	●	●	●	●	●	●	6.0	±0.03	0.2	26.4	4.5	5	1
N6004-GG	●	●	●	●	●	●	●	●	●	6.0	±0.03	0.4	26.4	4.5		
GCM N3002-GL	●	●	●	●	●	●	●	●	●	3.0	±0.03	0.2	21.1	3.8	5	1
N3004-GL	●	●	●	●	●	●	●	●	●	3.0	±0.03	0.4	21.1	3.8		
GCM N4002-GL	●	●	●	●	●	●	●	●	●	4.0	±0.03	0.2	26.4	4.0	5	1
N4004-GL	●	●	●	●	●	●	●	●	●	4.0	±0.03	0.4	26.4	4.0		
GCM N5002-GL	●	●	●	●	●	●	●	●	●	5.0	±0.03	0.2	26.4	4.1	5	1
N5004-GL	●	●	●	●	●	●	●	●	●	5.0	±0.03	0.4	26.4	4.1		
GCM N6002-GL	●	●	●	●	●	●	●	●	●	6.0	±0.03	0.2	26.4	4.5	5	1
N6004-GL	●	●	●	●	●	●	●	●	●	6.0	±0.03	0.4	26.4	4.5		
GCM N3002-GF	●	●	●	●	●	●	●	●	●	3.0	±0.03	0.2	21.1	3.8	5	1
N3004-GF	●	●	●	●	●	●	●	●	●	3.0	±0.03	0.4	21.1	3.8		
GCM N4002-GF	●	●	●	●	●	●	●	●	●	4.0	±0.03	0.2	26.4	4.0	5	1
N4004-GF	●	●	●	●	●	●	●	●	●	4.0	±0.03	0.4	26.4	4.0		
GCM N5002-GF	●	●	●	●	●	●	●	●	●	5.0	±0.03	0.2	26.4	4.1	5	1
N5004-GF	●	●	●	●	●	●	●	●	●	5.0	±0.03	0.4	26.4	4.1		
GCM N6002-GF	●	●	●	●	●	●	●	●	●	6.0	±0.03	0.2	26.4	4.5	5	1
N6004-GF	●	●	●	●	●	●	●	●	●	6.0	±0.03	0.4	26.4	4.5		

Part Number Suffix Code (Chipbreakers)

Type	Symbol	Applications	Type	Symbol	Applications
Grooving / Traverse Cutting	MG	Multi-functional / General-purpose	Profiling / Radius Grooving / Necking	RN	Facing / Necking / General-purpose
	ML	Multi-functional / Low-feed	Non-Ferrous Metals	GA	Non-Ferrous Metals / General-purpose
Grooving / Cut-off	GG	Grooving / General-purpose			
	GL	Grooving / Low-feed			
	GF	Grooving / Low cutting force			

Chipbreaker Selection P5 Recommended Cutting Conditions P11 Precautions for Use P14

Select holders and inserts with matching width of cut (CW). Not usable with GNDXL type / GNDIS type holders.

● mark: Standard stocked item Blank: Made-to-order item —mark: Not available

Guides
External Dia.
Face
Internal Dia.
Necking
SumiPolygon
Request Form
Application Examples



* For traverse cutting (groove expansion), use a multi-functional or profiling insert.

Deep Face Grooving L-Shaped (Side Cut) Clamp-on

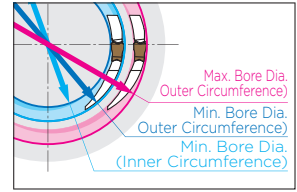
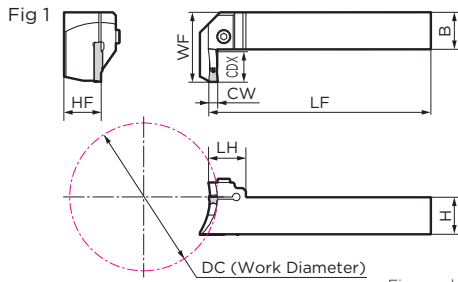
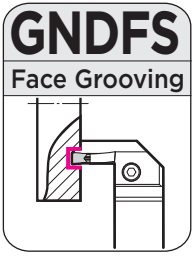

Holder

Figure shows right-handed (R) tool.

Parts Dimensions (mm)

Cat. No.	Stock		Height H	Width B	Overall Length LF	Cutting Edge Distance WF	Cutting Edge Height HF	Head LH	Machining diameter DC	Min. Bore Diameter Inner Circumference	Width of Cut CW	Maximum Groove Depth CDX	Applicable Insert	Cap Screw		Wrench	
	R	L												Fig			
GNDFS R/L2525M-620-070			25	25	150	47	25	25	70 to 100	58	6.0	20	GC □ N6000-□□	1	BX0520	5.0	LH040
R/L2525M-620-100			25	25	150	47	25	25	100 to 200	88	6.0	20		1			
R/L2525M-620-180			25	25	150	47	25	25	180 to 300	168	6.0	20		1			
R/L2525M-620-280			25	25	150	47	25	25	280 to 1000	268	6.0	20		1			
R/L2525M-620-450			25	25	150	47	25	25	450 up	438	6.0	20		1			
GNDFS R/L3232P-620-070			32	32	170	54	32	25	70 to 100	58	6.0	20	GC □ N6000-□□	1	BX0620	6.0	LH050
R/L3232P-620-100			32	32	170	54	32	25	100 to 200	88	6.0	20		1			
R/L3232P-620-180			32	32	170	54	32	25	180 to 300	168	6.0	20		1			
R/L3232P-620-280			32	32	170	54	32	25	280 to 1000	268	6.0	20		1			
R/L3232P-620-450			32	32	170	54	32	25	450 up	438	6.0	20		1			
GNDFS R/L2525M-820-070			25	25	150	47	25	30	70 to 100	54	8.0	20	GCM N8000-□□	1	BX0620	6.0	LH050
R/L2525M-820-100			25	25	150	47	25	30	100 to 200	84	8.0	20		1			
R/L2525M-820-180			25	25	150	47	25	30	180 to 300	164	8.0	20		1			
R/L2525M-820-280			25	25	150	47	25	30	280 to 1000	264	8.0	20		1			
R/L2525M-820-450			25	25	150	47	25	30	450 up	434	8.0	20		1			
GNDFS R/L3232P-820-070			32	32	170	54	32	30	70 to 100	54	8.0	20	GCM N8000-□□	1	BX0620	6.0	LH050
R/L3232P-820-100			32	32	170	54	32	30	100 to 200	84	8.0	20		1			
R/L3232P-820-180			32	32	170	54	32	30	180 to 300	164	8.0	20		1			
R/L3232P-820-280			32	32	170	54	32	30	280 to 1000	264	8.0	20		1			
R/L3232P-820-450			32	32	170	54	32	30	450 up	434	8.0	20		1			

Select holders and inserts with matching width of cut (CW). Refer to P39 for applicable inserts.

The maximum groove depth CDX is the figure during grooving. For maximum depth of cut during traverse cutting and profiling, refer to P11.

Inserts for GNDFS type

(Coated Carbide / Cermet / Cemented Carbide)

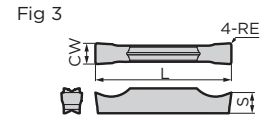
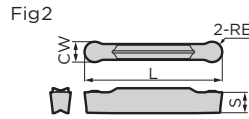
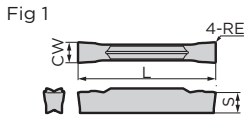

Grooving / Traverse Cutting

Dimensions (mm)

Cat. No.	AC8025P	AC8035P	AC830P	AC425K	AC5015S	AC5025S	AC520U	AC530U	T2500A	Width of Cut CW		Corner Radius RE	Overall Length L	Thickness S	Pcs/Pack	Fig
										Width of Cut	Tolerance					
										GCM N6004-MG N6008-MG	●	●	●	●	●	●
GCM N8004-MG N8008-MG	●	●	●	●	●	●	●	●	—	8.0	±0.04	0.4	28.8	6.0	5	1
GCM N6004-ML N6008-ML	●	●	●	●	●	●	●	●	—	6.0	±0.03	0.4	26.4	4.5	5	1
GCM N8004-ML N8008-ML	●	●	●	●	●	●	●	●	—	8.0	±0.04	0.4	28.8	6.0	5	1

Profiling / Radius Grooving / Necking

Dimensions (mm)

Cat. No.	AC8025P	AC8035P	AC830P	AC425K	AC5015S	AC5025S	AC520U	AC530U	Width of Cut CW		Corner Radius RE	Overall Length L	Thickness S	Pcs/Pack	Fig	
									Width of Cut	Tolerance						
									GCM N6030-RN	●	●	●	●	●	●	●

Non-Ferrous Metals

Dimensions (mm)

Cat. No.	H10	Width of Cut CW		Corner Radius RE	Overall Length L	Thickness S	Pcs/Pack	Fig
		Width of Cut	Tolerance					
		GCG N6004-GA	●	6.0	±0.025	0.4	26.4	4.5

Grooving / Cut-off

Dimensions (mm)

Cat. No.	AC8025P	AC8035P	AC830P	AC425K	AC5015S	AC5025S	AC520U	AC530U	T2500A	Width of Cut CW		Corner Radius RE	Overall Length L	Thickness S	Pcs/Pack	Fig
										Width of Cut	Tolerance					
										GCM N6002-GG N6004-GG	●	●	●	●	●	●
GCM N8004-GG	●	●	●	●	●	●	●	●	—	8.0	±0.04	0.4	28.8	6.0	5	1
GCM N6002-GL N6004-GL	●	●	●	●	●	●	●	●	—	6.0	±0.03	0.2	26.4	4.5	5	1
GCM N8004-GL	●	●	●	●	●	●	●	●	—	8.0	±0.04	0.4	28.8	6.0	5	1
GCM N6002-GF N6004-GF	●	●	●	●	●	●	●	●	—	6.0	±0.03	0.2	26.4	4.5	5	1
GCM N8002-GF N8004-GF	●	●	●	●	●	●	●	●	—	8.0	±0.04	0.2	28.8	6.0	5	1

Part Number Suffix Code (Chipbreakers)

Type	Symbol	Applications	Type	Symbol	Applications
Grooving / Traverse Cutting	MG ML	Multi-functional / General-purpose Multi-functional / Low-feed	Profiling / Radius Grooving / Necking Non-Ferrous Metals	RN GA	Facing / Necking / General-purpose Non-Ferrous Metals / General-purpose
Grooving / Cut-off	GG GL GF	Grooving / General-purpose Grooving / Low-feed Grooving / Low cutting force			

Chipbreaker Selection P5 Recommended Cutting Conditions P11 Precautions for Use P14

Select holders and inserts with matching width of cut (CW). Not usable with GNDXL type / GNDIS type holders.

● mark: Standard stocked item Blank: Made-to-order item —mark: Not available



Internal Grooving
Clamp-on

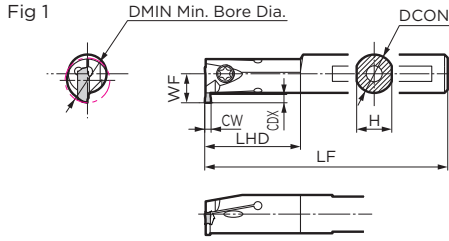
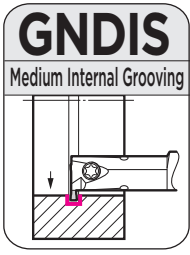

Figure shows right-handed (R) tool.



Holder

Parts

Dimensions (mm)

Cat. No.	Stock		Diameter DCON	Height H	Overall Length LF	Head LHD	Cutting Edge Distance WF	Min. Bore Dia. DMIN	Width of Cut CW	Maximum Groove Depth CDX	Applicable Insert	Fig	Flat Head Screw		Wrench
	R	L												N·m	
GNDIS R/L1214-T1526	●	●	12	11	150	30	9.0	14	1.5	2.6	GXM N150005S-GF	1	BFTX0409N	3.4	LT15
R/L1214-T1536	●	●	12	11	150	30	10.0	14	1.5	3.6		1			
R/L1616-T1536	●	●	16	15	160	35	11.5	16	1.5	3.6		1			
GNDIS R/L1620-T1546	●	●	16	15	160	40	14.5	20	1.5	4.6	GXM N2002S-□□	1	BFTX0511N	5.0	LT20
R/L2025-T1566	●	●	20	19	180	40	19.0	25	1.5	6.6		1			
GNDIS R/L1214-T2026	●	●	12	11	150	30	9.0	14	2.0	2.6		1			
R/L1214-T2036	●	●	12	11	150	30	10.0	14	2.0	3.6	GXM N3002S-□□	1	BFTX0409N	3.4	LT15
R/L1616-T2036	●	●	16	15	160	35	11.5	16	2.0	3.6		1			
GNDIS R/L1620-T2046	●	●	16	15	160	40	14.5	20	2.0	4.6		1			
R/L2025-T2066	●	●	20	19	180	40	19.0	25	2.0	6.6	1	BFTX0511N	5.0	LT20	
GNDIS R/L1214-T3026	●	●	12	11	150	30	9.0	14	3.0	2.6	GXM N3002S-□□	1	BFTX0409N	3.4	LT15
R/L1214-T3036	●	●	12	11	150	30	10.0	14	3.0	3.6		1			
R/L1616-T3036	●	●	16	15	160	35	11.5	16	3.0	3.6		1			
GNDIS R/L1620-T3046	●	●	16	15	160	40	14.5	20	3.0	4.6	GXM N3002S-□□	1	BFTX0511N	5.0	LT20
R/L2025-T3066	●	●	20	19	180	40	19.0	25	3.0	6.6		1			

Select holders and inserts with matching width of cut (CW). **Only GXM inserts can be used.** Refer to P41 for applicable inserts.
The maximum groove depth CDX is the figure during grooving. For maximum depth of cut during traverse cutting and profiling, refer to P41.

Inserts for GNDIS type

(Coated Carbide)

Fig 1

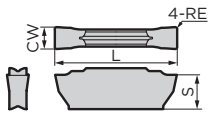

Grooving / Traverse Cutting

Dimensions (mm)

Cat. No.	AC520U		AC1030U		Width of Cut CW		Corner Radius RE	Overall Length L	Thickness S	Pcs/Pack	Fig
	●	●			Width of Cut	Tolerance					
	GXM N2002S-ML	●	●			2.0	±0.03	0.2	11.1	3.1	5
N3002S-ML	●	●			3.0	±0.03	0.2	11.1	3.1		1

Grooving / Cut-off

Dimensions (mm)

Cat. No.	AC520U		AC1030U		Width of Cut CW		Corner Radius RE	Overall Length L	Thickness S	Pcs/Pack	Fig
	—	●			Width of Cut	Tolerance					
	GXM N150005S-GF	—	●			1.5	±0.03	0.05	11.1	3.1	
GXM N2002S-GF	●	●			2.0	±0.03	0.2	11.1	3.1	5	1
N3002S-GF	●	●			3.0	±0.03	0.2	11.1	3.1		1

Select holders and inserts with matching width of cut (CW). GCM/GCG inserts are not mutually compatible.

■ **Recommended Cutting Conditions (GNDIS)**

Work Material	P Carbon Steel / Alloy Steel		M Stainless Steel		K Cast Iron		S Exotic Alloy	
Insert Grade	AC520U	AC1030U	AC520U	AC1030U	AC520U	AC1030U	AC520U	AC1030U
Cutting Speed vc (m/min)	80-200	50-200	70-150	50-150	60-200	50-200	20-80	20-60

■ **Grooving / Cut-off / Necking**

Chipbreaker		Feed Rate f (mm/rev)	
		ML	GF
Width of Cut CW (mm)	1.5	—	0.02 to 0.10
	2.0	0.03 to 0.12	0.03 to 0.12
	3.0	0.05 to 0.15	0.05 to 0.15

■ **Traverse Cutting**

Chipbreaker		ML	
		Feed Rate f (mm/rev)	Depth of Cut ap (mm)
Width of Cut CW (mm)	2.0	0.03 to 0.12	0.2 to 0.8
	3.0	0.05 to 0.15	0.3 to 1.2

Precautions for Use



Internal Grooving
 Clamp-on

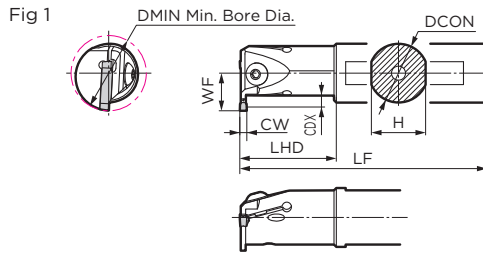

Figure shows right-handed (R) tool.

Holder

Parts

Dimensions (mm)

Cat. No.	Stock		Diameter DCON	Height H	Head LHD	Overall Length LF	Cutting Edge Distance WF	Min. Bore Dia. DMIN	Width of Cut CW	Maximum Groove Depth CDX	Applicable Insert	Fig	Bolt		Wrench
	R	L												N-m	
GNDI R/L2532-T206	●	●	25	23	40	200	16	32	2.0	6	GC□ N2000-□□	1	BH0516	5.0	LH030
R/L3240-T210	●	●	32	30	50	250	26	40	2.0	10		1	BH0616	6.0	LH040
GNDI R/L2532-T306	●	●	25	23	40	200	16	32	3.0	6	GC□ N3000-□□	1	BH0516	5.0	LH030
R/L3240-T310	●	●	32	30	50	250	26	40	3.0	10		1	BH0616	6.0	LH040
R/L4050-T311	●	●	40	38	60	300	31	50	3.0	11		1	BH0616	6.0	LH040
GNDI R/L2532-T406	●	●	25	23	40	200	19	32	4.0	6	GC□ N4000-□□	1	BH0516	5.0	LH030
R/L3240-T410	●	●	32	30	50	250	26	40	4.0	10		1	BH0616	6.0	LH040
R/L4050-T411	●	●	40	38	60	300	31	50	4.0	11		1	BH0616	6.0	LH040
GNDI R/L2532-T506	●	●	25	23	40	200	19	32	5.0	6	GC□ N5000-□□	1	BH0516	5.0	LH030
R/L3240-T510	●	●	32	30	50	250	26	40	5.0	10		1	BH0616	6.0	LH040
R/L4050-T511	●	●	40	38	60	300	31	50	5.0	11		1	BH0616	6.0	LH040
GNDI R/L4050-T611	●	●	40	38	60	300	31	50	6.0	11	GC□ N6000-□□	1	BH0616	6.0	LH040

Select holders and inserts with matching width of cut (CW). Refer to P43 for applicable inserts.

The maximum groove depth CDX is the figure during grooving. For maximum depth of cut during traverse cutting and profiling, refer to P11.

Inserts for GNDI type

(Coated Carbide / Cermet / Cemented Carbide)

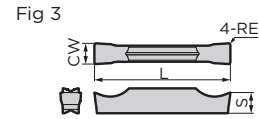
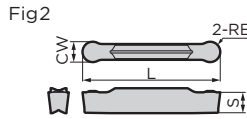
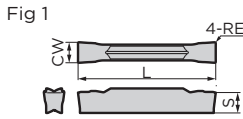

Grooving / Traverse Cutting

Dimensions (mm)

Cat. No.	AC8025P	AC8035P	AC830P	AC425K	AC5015S	AC5025S	AC520U	AC530U	T2500A	Width of Cut CW				Pcs/Pack	Fig	
										Width of Cut		RE	L			S
										Width of Cut	Tolerance					
GCM N3002-MG	●	●	●	●	●	●	●	●	●	3.0	±0.03	0.2	21.1	3.8	1	
N3004-MG	●	●	●	●	●	●	●	●	—	3.0	±0.03	0.4	21.1	3.8	1	
GCM N4002-MG	●	●	●	●	●	●	●	●	●	4.0	±0.03	0.2	26.4	4.0	1	
N4004-MG	●	●	●	●	●	●	●	●	—	4.0	±0.03	0.4	26.4	4.0	1	
N4008-MG	●	●	●	●	●	●	●	●	—	4.0	±0.03	0.8	26.4	4.0	5	
GCM N5004-MG	●	●	●	●	●	●	●	●	●	5.0	±0.03	0.4	26.4	4.1	1	
N5008-MG	●	●	●	●	●	●	●	●	—	5.0	±0.03	0.8	26.4	4.1	1	
GCM N6004-MG	●	●	●	●	●	●	●	●	●	6.0	±0.03	0.4	26.4	4.5	1	
N6008-MG	●	●	●	●	●	●	●	●	—	6.0	±0.03	0.8	26.4	4.5	1	
GCM N2002-ML	—	—	—	—	—	—	—	—	—	2.0	±0.03	0.2	21.1	3.6	1	
N3002-ML	●	●	●	●	●	●	●	●	—	3.0	±0.03	0.2	21.1	3.8	1	
N3004-ML	●	●	●	●	●	●	●	●	—	3.0	±0.03	0.4	21.1	3.8	1	
GCM N4002-ML	●	●	●	●	●	●	●	●	●	4.0	±0.03	0.2	26.4	4.0	1	
N4004-ML	●	●	●	●	●	●	●	●	—	4.0	±0.03	0.4	26.4	4.0	1	
N4008-ML	●	●	●	●	●	●	●	●	—	4.0	±0.03	0.8	26.4	4.0	5	
GCM N5004-ML	●	●	●	●	●	●	●	●	●	5.0	±0.03	0.4	26.4	4.1	1	
N5008-ML	●	●	●	●	●	●	●	●	—	5.0	±0.03	0.8	26.4	4.1	1	
GCM N6004-ML	●	●	●	●	●	●	●	●	●	6.0	±0.03	0.4	26.4	4.5	1	
N6008-ML	●	●	●	●	●	●	●	●	—	6.0	±0.03	0.8	26.4	4.5	1	

Profiling / Radius Grooving / Necking

Dimensions (mm)

Cat. No.	AC8025P	AC8035P	AC830P	AC425K	AC5015S	AC5025S	AC520U	AC530U	Width of Cut CW				Pcs/Pack	Fig	
									Width of Cut		RE	L			S
									Width of Cut	Tolerance					
GCM N2010-RN	—	—	—	—	—	—	—	—	—	2.0	±0.03	1.0	21.7	3.6	2
N3015-RN	●	●	●	●	●	●	●	●	—	3.0	±0.03	1.5	22.6	3.8	2
N4020-RN	●	●	●	●	●	●	●	●	—	4.0	±0.03	2.0	28.2	4.0	5
N5025-RN	●	●	●	●	●	●	●	●	—	5.0	±0.03	2.5	28.3	4.1	2
N6030-RN	●	●	●	●	●	●	●	●	—	6.0	±0.03	3.0	28.3	4.5	2

Non-Ferrous Metals

Dimensions (mm)

Cat. No.	H10	Width of Cut CW				Pcs/Pack	Fig	
		Width of Cut		RE	L			S
		Width of Cut	Tolerance					
GCG N2002-GA	●	—	—	—	—	—	3	
N3002-GA	●	—	—	—	—	—	3	
GCG N4004-GA	●	—	—	—	—	—	3	
N5004-GA	●	—	—	—	—	—	3	
N6004-GA	●	—	—	—	—	—	3	

Grooving / Cut-off

Dimensions (mm)

Cat. No.	AC8025P	AC8035P	AC830P	AC425K	AC5015S	AC5025S	AC520U	AC530U	T2500A	Width of Cut CW				Pcs/Pack	Fig	
										Width of Cut		RE	L			S
										Width of Cut	Tolerance					
GCM N2002-GG	—	●	●	—	●	●	●	●	—	2.0	±0.03	0.2	21.1	3.6	1	
GCM N3002-GG	—	●	●	—	●	●	●	●	—	3.0	±0.03	0.2	21.1	3.8	1	
N3004-GG	—	●	●	—	●	●	●	●	—	3.0	±0.03	0.4	21.1	3.8	1	
GCM N4002-GG	—	●	●	—	●	●	●	●	—	4.0	±0.03	0.2	26.4	4.0	1	
N4004-GG	—	●	●	—	●	●	●	●	—	4.0	±0.03	0.4	26.4	4.0	5	
GCM N5002-GG	—	●	●	—	●	●	●	●	—	5.0	±0.03	0.2	26.4	4.1	1	
N5004-GG	—	●	●	—	●	●	●	●	—	5.0	±0.03	0.4	26.4	4.1	1	
GCM N6002-GG	—	●	●	—	●	●	●	●	—	6.0	±0.03	0.2	26.4	4.5	1	
N6004-GG	—	●	●	—	●	●	●	●	—	6.0	±0.03	0.4	26.4	4.5	1	
GCM N2002-GL	—	●	●	—	—	—	—	—	—	2.0	±0.03	0.2	21.1	3.6	1	
N2004-GL	—	●	●	—	—	—	—	—	—	2.0	±0.03	0.4	21.1	3.6	1	
GCM N3002-GL	—	●	●	—	●	●	●	●	—	3.0	±0.03	0.2	21.1	3.8	1	
N3004-GL	—	●	●	—	●	●	●	●	—	3.0	±0.03	0.4	21.1	3.8	1	
GCM N4002-GL	—	●	●	—	●	●	●	●	—	4.0	±0.03	0.2	26.4	4.0	1	
N4004-GL	—	●	●	—	●	●	●	●	—	4.0	±0.03	0.4	26.4	4.0	5	
GCM N5002-GL	—	●	●	—	●	●	●	●	—	5.0	±0.03	0.2	26.4	4.1	1	
N5004-GL	—	●	●	—	●	●	●	●	—	5.0	±0.03	0.4	26.4	4.1	1	
GCM N6002-GL	—	●	●	—	●	●	●	●	—	6.0	±0.03	0.2	26.4	4.5	1	
N6004-GL	—	●	●	—	●	●	●	●	—	6.0	±0.03	0.4	26.4	4.5	1	
GCM N2002-GF	—	—	—	—	●	●	—	—	—	2.0	±0.03	0.2	21.1	3.6	1	
N2004-GF	—	—	—	—	●	●	—	—	—	2.0	±0.03	0.4	21.1	3.6	1	
GCM N3002-GF	—	●	●	—	●	●	●	●	—	3.0	±0.03	0.2	21.1	3.8	1	
N3004-GF	—	●	●	—	●	●	●	●	—	3.0	±0.03	0.4	21.1	3.8	1	
GCM N4002-GF	—	●	●	—	●	●	●	●	—	4.0	±0.03	0.2	26.4	4.0	1	
N4004-GF	—	●	●	—	●	●	●	●	—	4.0	±0.03	0.4	26.4	4.0	5	
GCM N5002-GF	—	●	●	—	●	●	●	●	—	5.0	±0.03	0.2	26.4	4.1	1	
N5004-GF	—	●	●	—	●	●	●	●	—	5.0	±0.03	0.4	26.4	4.1	1	
GCM N6002-GF	—	●	●	—	●	●	●	●	—	6.0	±0.03	0.2	26.4	4.5	1	
N6004-GF	—	●	●	—	●	●	●	●	—	6.0	±0.03	0.4	26.4	4.5	1	

Part Number Suffix Code (Chipbreakers)

Type	Symbol	Applications	Type	Symbol	Applications
Grooving / Traverse Cutting	MG	Multi-functional / General-purpose	Profiling / Radius Grooving / Necking	RN	Facing / Necking / General-purpose
	ML	Multi-functional / Low-feed	Non-Ferrous Metals	GA	Non-Ferrous Metals / General-purpose
Grooving / Cut-off	GG	Grooving / General-purpose			
	GL	Grooving / Low-feed			
	GF	Grooving / Low cutting force			

Chipbreaker Selection P5 Recommended Cutting Conditions P11 Precautions for Use P14

Select holders and inserts with matching width of cut (CW). Not usable with GNDXL type / GNDIS type holders.

● mark: Standard stocked item Blank: Made-to-order item —mark: Not available



SumiPolygon Cassette for External Grooving
Clamp-on

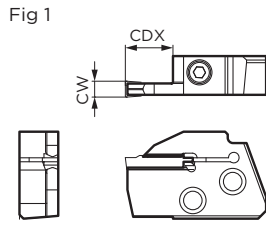

Figure shows right-handed (R) tool.

SumiPolygon GND series Cassette

Parts Dimensions (mm)

Cat. No.	Stock		Width of Cut CW	Maximum Groove Depth CDX	Applicable Insert	Applicable Holder	Fig	Cap Screw		Wrench
	R	L						N-m		
GNDCM R/L 212	●	●	2	12	GC□□2000-□□		1			
R/L 312	●	●	3	12	GC□□3000-□□	PSC00GND000000 R/L	1			
R/L 418	●	●	4	18	GC□□4000-□□		1	BX0512	5.0	LH040
R/L 518	●	●	5	18	GC□□5000-□□	PSC00GND000090 R/L	1			
R/L 618	●	●	6	18	GC□□6000-□□		1			

Select holders and inserts with matching width of cut (CW). Refer to P45 for applicable inserts.
The maximum groove depth CDX is the figure during grooving. For maximum depth of cut during traverse cutting and profiling, refer to P11.

Identification Code
Cassette

GNDCM R 2 12
Series Code Feed Direction of Cut (mm) Width of Cut (mm) Maximum Groove Depth (mm)

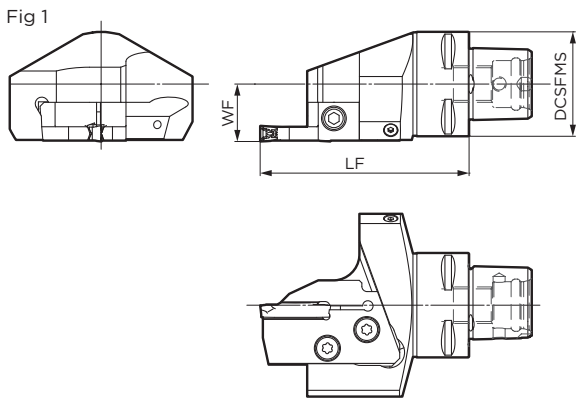

Figure shows right-handed (R) tool.

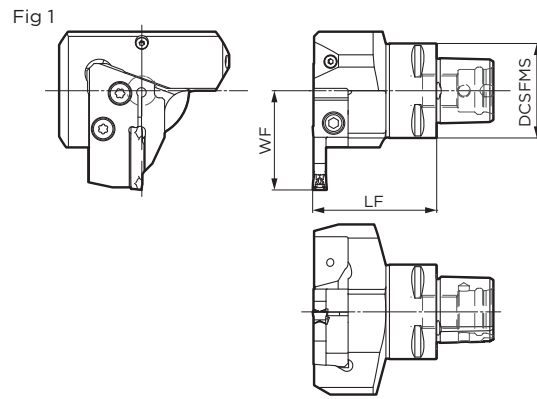

Figure shows right-handed (R) tool.

SumiPolygon GND series Tool Holder (Straight) Parts Dimensions (mm)

Cat. No.	Stock		Cutting Edge WF	Overhang LF	Mounting DCS-FMS	Applicable Cassettes	Fig	Flat Head Screw		Wrench
	R	L						N-m		
PSC40 GND 228000 R/L	●	●	22	80	40	GNDCM R/L000	1	BFTX0619N	7.5	TT25
PSC50 GND 278000 R/L	●	●	27	80	50		1			
PSC63 GND 338000 R/L	●	●	33	80	63		1			

Inserts and cassettes are not included with the holders.

SumiPolygon GND series Tool Holder (L type) Parts Dimensions (mm)

Cat. No.	Stock		Cutting Edge WF	Overhang LF	Mounting DCS-FMS	Applicable Cassettes	Fig	Flat Head Screw		Wrench
	R	L						N-m		
PSC40 GND 425290 R/L	●	●	42	52.5	40	GNDCM L/RO00	1	BFTX0619N	7.5	TT25
PSC50 GND 475590 R/L	●	●	47	55	50		1			
PSC63 GND 545790 R/L	●	●	54	57	63		1			

Inserts and cassettes are not included with the holders.

Identification Code
Holder

PSC40 GND 42 52 90 R
SumiPolygon Shank Size Series Code: GND series WF Dimension (mm) LF Dimension (mm) 00: Straight Feed Direction 90: L type

● mark: Standard stocked item Recommended Tightening Torque (N-m)

Inserts for GNDCM type

Fig 1

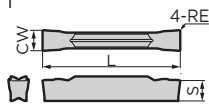
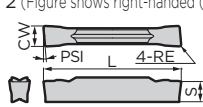

Fig 2 (Figure shows right-handed (R) tool.)



(Coated Carbide / Cermet / Cemented Carbide)

Fig 3

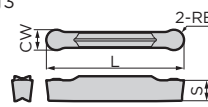
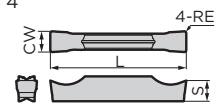

Fig 4



Grooving / Traverse Cutting

Dimensions (mm)

Cat. No.	AC8025P	AC8035P	AC830P	AC425K	AC5015S	AC5025S	AC520U	AC530U	T2500A	Width of Cut CW				Pcs/Pack	Fig	
										Width of Cut		RE	L			S
										Width of Cut	Tolerance					
GCM N3002-MG	●	●	●	●	●	●	●	●	●	3.0	±0.03	0.2	21.1	3.8	1	
N3004-MG	●	●	●	●	●	●	●	●	●	3.0	±0.03	0.4	21.1	3.8	1	
GCM N4002-MG	●	●	●	●	●	●	●	●	●	4.0	±0.03	0.2	26.4	4.0	1	
N4004-MG	●	●	●	●	●	●	●	●	●	4.0	±0.03	0.4	26.4	4.0	1	
N4008-MG	●	●	●	●	●	●	●	●	●	4.0	±0.03	0.8	26.4	4.0	5	
GCM N5004-MG	●	●	●	●	●	●	●	●	●	5.0	±0.03	0.4	26.4	4.1	1	
N5008-MG	●	●	●	●	●	●	●	●	●	5.0	±0.03	0.8	26.4	4.1	1	
GCM N6004-MG	●	●	●	●	●	●	●	●	●	6.0	±0.03	0.4	26.4	4.5	1	
N6008-MG	●	●	●	●	●	●	●	●	●	6.0	±0.03	0.8	26.4	4.5	1	
GCM N2002-ML	●	●	●	●	●	●	●	●	●	2.0	±0.03	0.2	21.1	3.6	1	
N3002-ML	●	●	●	●	●	●	●	●	●	3.0	±0.03	0.2	21.1	3.8	1	
N3004-ML	●	●	●	●	●	●	●	●	●	3.0	±0.03	0.4	21.1	3.8	1	
GCM N4002-ML	●	●	●	●	●	●	●	●	●	4.0	±0.03	0.2	26.4	4.0	1	
N4004-ML	●	●	●	●	●	●	●	●	●	4.0	±0.03	0.4	26.4	4.0	1	
N4008-ML	●	●	●	●	●	●	●	●	●	4.0	±0.03	0.8	26.4	4.0	5	
GCM N5004-ML	●	●	●	●	●	●	●	●	●	5.0	±0.03	0.4	26.4	4.1	1	
N5008-ML	●	●	●	●	●	●	●	●	●	5.0	±0.03	0.8	26.4	4.1	1	
GCM N6004-ML	●	●	●	●	●	●	●	●	●	6.0	±0.03	0.4	26.4	4.5	1	
N6008-ML	●	●	●	●	●	●	●	●	●	6.0	±0.03	0.8	26.4	4.5	1	

Grooving / Cut-off

Dimensions (mm)

Cat. No.	AC8025P	AC8035P	AC830P	AC425K	AC5015S	AC5025S	AC520U	AC530U	T2500A	Width of Cut CW				Pcs/Pack	Fig	
										Width of Cut		RE	L			S
										Width of Cut	Tolerance					
GCM N2002-GG	●	●	●	●	●	●	●	●	●	2.0	±0.03	0.2	21.1	3.6	1	
N3002-GG	●	●	●	●	●	●	●	●	●	3.0	±0.03	0.2	21.1	3.8	1	
N3004-GG	●	●	●	●	●	●	●	●	●	3.0	±0.03	0.4	21.1	3.8	1	
GCM N4002-GG	●	●	●	●	●	●	●	●	●	4.0	±0.03	0.2	26.4	4.0	1	
N4004-GG	●	●	●	●	●	●	●	●	●	4.0	±0.03	0.4	26.4	4.0	5	
N4008-GG	●	●	●	●	●	●	●	●	●	4.0	±0.03	0.8	26.4	4.0	1	
GCM N5002-GG	●	●	●	●	●	●	●	●	●	5.0	±0.03	0.2	26.4	4.1	1	
N5004-GG	●	●	●	●	●	●	●	●	●	5.0	±0.03	0.4	26.4	4.1	1	
N5008-GG	●	●	●	●	●	●	●	●	●	5.0	±0.03	0.8	26.4	4.1	1	
GCM N6002-GG	●	●	●	●	●	●	●	●	●	6.0	±0.03	0.2	26.4	4.5	1	
N6004-GG	●	●	●	●	●	●	●	●	●	6.0	±0.03	0.4	26.4	4.5	1	
N6008-GG	●	●	●	●	●	●	●	●	●	6.0	±0.03	0.8	26.4	4.5	1	
GCM N2002-GL	●	●	●	●	●	●	●	●	●	2.0	±0.03	0.2	21.1	3.6	1	
N2004-GL	●	●	●	●	●	●	●	●	●	2.0	±0.03	0.4	21.1	3.6	1	
GCM N3002-GL	●	●	●	●	●	●	●	●	●	3.0	±0.03	0.2	21.1	3.8	1	
N3004-GL	●	●	●	●	●	●	●	●	●	3.0	±0.03	0.4	21.1	3.8	1	
GCM N4002-GL	●	●	●	●	●	●	●	●	●	4.0	±0.03	0.2	26.4	4.0	1	
N4004-GL	●	●	●	●	●	●	●	●	●	4.0	±0.03	0.4	26.4	4.0	5	
N4008-GL	●	●	●	●	●	●	●	●	●	4.0	±0.03	0.8	26.4	4.0	1	
GCM N5002-GL	●	●	●	●	●	●	●	●	●	5.0	±0.03	0.2	26.4	4.1	1	
N5004-GL	●	●	●	●	●	●	●	●	●	5.0	±0.03	0.4	26.4	4.1	1	
N5008-GL	●	●	●	●	●	●	●	●	●	5.0	±0.03	0.8	26.4	4.1	1	
GCM N6002-GL	●	●	●	●	●	●	●	●	●	6.0	±0.03	0.2	26.4	4.5	1	
N6004-GL	●	●	●	●	●	●	●	●	●	6.0	±0.03	0.4	26.4	4.5	1	
N6008-GL	●	●	●	●	●	●	●	●	●	6.0	±0.03	0.8	26.4	4.5	1	
GCM N125005-GF	●	●	●	●	●	●	●	●	●	1.25	±0.03	0.05	17.4	3.2	1	
N150005-GF	●	●	●	●	●	●	●	●	●	1.5	±0.03	0.05	17.8	3.7	1	
GCM N2002-GF	●	●	●	●	●	●	●	●	●	2.0	±0.03	0.2	21.1	3.6	1	
N2004-GF	●	●	●	●	●	●	●	●	●	2.0	±0.03	0.4	21.1	3.6	1	
GCM N3002-GF	●	●	●	●	●	●	●	●	●	3.0	±0.03	0.2	21.1	3.8	1	
N3004-GF	●	●	●	●	●	●	●	●	●	3.0	±0.03	0.4	21.1	3.8	1	
N3008-GF	●	●	●	●	●	●	●	●	●	3.0	±0.03	0.8	21.1	3.8	1	
GCM N4002-GF	●	●	●	●	●	●	●	●	●	4.0	±0.03	0.2	26.4	4.0	1	
N4004-GF	●	●	●	●	●	●	●	●	●	4.0	±0.03	0.4	26.4	4.0	1	
N4008-GF	●	●	●	●	●	●	●	●	●	4.0	±0.03	0.8	26.4	4.0	1	
GCM N5002-GF	●	●	●	●	●	●	●	●	●	5.0	±0.03	0.2	26.4	4.1	1	
N5004-GF	●	●	●	●	●	●	●	●	●	5.0	±0.03	0.4	26.4	4.1	1	
N5008-GF	●	●	●	●	●	●	●	●	●	5.0	±0.03	0.8	26.4	4.1	1	
GCM N6002-GF	●	●	●	●	●	●	●	●	●	6.0	±0.03	0.2	26.4	4.5	1	
N6004-GF	●	●	●	●	●	●	●	●	●	6.0	±0.03	0.4	26.4	4.5	1	
N6008-GF	●	●	●	●	●	●	●	●	●	6.0	±0.03	0.8	26.4	4.5	1	

Cut-off (Handed Edge)

Dimensions (mm)

Cat. No.	AC8025P	AC8035P	AC830P	AC5015S	AC5025S	AC520U	AC530U	AC1030U	Lead Angle	Width of Cut CW				Pcs/Pack	Fig	
										Width of Cut		RE	L			S
										Width of Cut	Tolerance					
GCM R2002-CG-05	●	●	●	●	●	●	●	●	5°	2.0	±0.03	0.2	21.1	3.6	2	
L2002-CG-05	●	●	●	●	●	●	●	●	5°	2.0	±0.03	0.2	21.1	3.6	2	
GCM R3002-CG-05	●	●	●	●	●	●	●	●	5°	3.0	±0.03	0.2	21.3	3.8	2	
L3002-CG-05	●	●	●	●	●	●	●	●	5°	3.0	±0.03	0.2	21.3	3.8	2	
GCM R4002-CG-05	●	●	●	●	●	●	●	●	5°	4.0	±0.04	0.2	26.7	4.0	2	
L4002-CG-05	●	●	●	●	●	●	●	●	5°	4.0	±0.04	0.2	26.7	4.0	2	
GCM R20003-CF-10	●	●	●	●	●	●	●	●	10°	2.0	±0.08	0.03	22.4	3.6	2	
L20003-CF-10	●	●	●	●	●	●	●	●	10°	2.0	±0.08	0.03	22.4	3.6	2	
GCM R30003-CF-10	●	●	●	●	●	●	●	●	10°	3.0	±0.08	0.03	22.4	3.8	2	
L30003-CF-10	●	●	●	●	●	●	●	●	10°	3.0	±0.08	0.03	22.4	3.8	2	
GCM R20003-CF-15	●	●	●	●	●	●	●	●	15°	2.0	±0.08	0.03	22.4	3.6	2	
L20003-CF-15	●	●	●	●	●	●	●	●	15°	2.0	±0.08	0.03	22.4	3.6	2	
GCM R30003-CF-15	●	●	●	●	●	●	●	●	15°	3.0	±0.08	0.03	22.4	3.8	2	
L30003-CF-15	●	●	●	●	●	●	●	●	15°	3.0	±0.08	0.03	22.4	3.8	2	

GCMR: Right-handed, GCMCL: Left-handed

External Profiling / External Radius Grooving

Dimensions (mm)

Cat. No.	AC8025P	AC8035P	AC830P	AC425K	AC5015S	AC5025S	AC520U	AC530U	T2500A	Width of Cut CW				Pcs/Pack	Fig	
										Width of Cut		RE	L			S
										Width of Cut	Tolerance					
GCM N3015-RG	●	●	●	●	●	●	●	●	●	3.0	±0.03	1.5	21.1	3.8	3	
N4020-RG	●	●	●	●	●	●	●	●	●	4.0	±0.03	2.0	26.4	4.0	3	
GCM N5025-RG	●	●	●	●	●	●	●	●	●	5.0	±0.03	2.5	27.2	4.1	3	
N6030-RG	●	●	●	●	●	●	●	●	●	6.0	±0.03	3.0	27.5	4.5	3	

Profiling / Radius Grooving / Necking

Dimensions (mm)

Cat. No.	AC8025P	AC8035P	AC830P	AC425K	AC5015S	AC5025S	AC520U	AC530U	Width of Cut CW				Pcs/Pack	Fig	
									Width of Cut		RE	L			S
									Width of Cut	Tolerance					
GCM N2010-RN	●	●	●	●	●	●	●	●	●	2.0	±0.03	1.0	21.7	3.6	3
N3015-RN	●	●	●	●	●	●	●	●	●	3.0	±0.03	1.5	22.6	3.8	3
N4020-RN	●	●	●	●	●	●	●	●	●	4.0	±0.03	2.0	28.2	4.0	5
N5025-RN	●	●	●</												

SEC-Grooving Tool GND series Special Grooving Insert Request Form

Applicable Tool Holders (Width of Cut 2 to 6mm)

External Turning: GNDS type (→P22), GNDM type (→P18, P20, P24, P26), GNDMS type (→P24), GNDL type (→P18, P20, P28, P30), GNDLS type (→P28), GNDCM type (→P44) *GNDXL Types cannot be used as the insert shape is different

Internal Boring: GNDI type (→P42) *GNDIS types cannot be used as the insert shape is different

Facing: GNDF type (→P36), GNDFS type (→P38)

Special inserts with ground chipbreaker (customised width of cut and insert corner radius) can be made-to-order. To order, fill out the form below (indicate preference by circling the item or specify dimensions), and send it to a Sumitomo Electric Hardmetal dealer or distributor. (Make a copy of this form.) For grooving inserts with shape, width of cut or grade other than those listed below, contact your nearest Sumitomo Electric Hardmetal sales office (refer to the back of this catalog).

Your Company / Contact Information (Phone / Fax / Address, etc.)

Shape	Item	Description
	Width of Cut CW (2.00 to 6.59mm)	mm
	Corner Radius RER	mm
	Corner Radius REL	mm
	Grade(Select from right)*1	AC530U / AC520U / EH520 / H10 / KH03 CBN Grade / PCD Grade
	Grooving Depth CDX *2	mm
	<p>*1: If H10 is selected as the grade, the cutting edge will have a sharp edge. *2: Set the chipbreaker width based on CDX. The actual groove depth can only be less than or equal to the maximum groove depth configurable by each holder.</p>	

Form instructions

- The applicable standard holder depends on the width of cut. Refer to the chart on the right for manufacturable widths of cut and corner radius range for facing. (If using a corner radius exceeding this for facing, modification is required to prevent the holder from interfering with the work material.)
- The corner radius maximum value for external turning and internal boring is 1/2 the width of cut.
- Width of cut (CW) tolerance is ±0.025mm when manufactured.
- WF dimensions for each holder are the CWS value for the applicable holder standard insert width of cut as follows.
 (Standard holder dimension WF) + (WF - CWS) / 2
- For inch widths of cut, inserts can also be supplied partially unground.

Contact your local sales office for details.

Width of Cut CW (Nominal Value)	Applicable Standard Holder	Corner radius (RER, REL) maximum value when used for facing (standard holder applicable)
2.00 to 2.59mm	2mm Width Holder	0.2mm
2.60 to 3.59mm	3mm Width Holder	0.4mm
3.60 to 4.59mm	4mm Width Holder	0.8mm
4.60 to 5.59mm	5mm Width Holder	
5.60 to 6.59mm	6mm Width Holder	

SEC-Grooving Tool GND series 90° Insert Request Form *New*

Applicable holders: Inquire along with inserts.

To order, fill out the form below (indicate your preference by circling the item or specify dimensions), and send it to a Sumitomo Electric Hardmetal dealer or distributor. (Make a copy of this form.)
 For grooving inserts with shape, width of cut or grade other than those listed below, contact your nearest Sumitomo Electric Hardmetal sales office (refer to the back of this catalog).

Your Company / Contact Information (Phone / Fax / Address, etc.)

Shape	Item	Description
	Width of Cut CW (2.00 to 6.00mm)	mm
	Corner Radius RER	mm
	Corner Radius REL	mm
	Grade (Select from right)	EH510 / EH520 / AC5015S / AC5025S
	Grooving Depth CDX	mm
	Cutting Edge Position L (5.80mm up) (Enter the maximum allowable value)	mm
	Feed Direction	Right-handed / Left-handed
	Insert Thickness (Select from right)	Standard / High rigidity

Workpiece machining part and machining method (Select one of the options below and enter the machining diameter)		
Facing	External Machining	Internal Machining
Machining Dia.: <input type="text"/> mm	Machining Dia.: <input type="text"/> mm	Machining Dia.: <input type="text"/> mm

Guides
 External Dia.
 Face
 Internal Dia.
 Necking
 SumiPolygon
 Request Form
 Application Examples

■ Application Examples

S15C Automotive Component Grooving		P
<p>Point</p> <ul style="list-style-type: none"> · Machining efficiency · Tool life 		
<p>Holders GNDM R2525K-312J</p> <p>Insert GCM N3004-GG</p> <p>Width of Cut: 3.0mm</p> <p>Cutting Conditions vc=152 (91) m/min f=0.10 (0.05) mm/rev ap=9.5mm</p> <p>Wet → Internal Coolant Supply 2.1MPa (*) indicates value for competitors' products</p>		
<p>GND series</p> <p>Cutting Time (sec/pc)</p> <p>1.2 sec/pc</p> <p>Competitor's Product 3.6 sec/pc</p>	<p>GND series</p> <p>Tool Life (pcs.)</p> <p>1,000 pcs</p> <p>Competitor's Product 250 pcs</p>	
<ul style="list-style-type: none"> · Double the feed rate of conventional tools, with no chatter · 1.5 times the cutting speed thanks to an internal coolant holder, achieving 4 times longer tool life 		

SCM440 Office Machine Component Grooving		P
<p>Point</p> <ul style="list-style-type: none"> · Chip control · Machining efficiency 		
<p>Holders GNDL R2525M-320</p> <p>Insert GCM N3002-GG</p> <p>Width of Cut: 3.0mm</p> <p>Cutting Conditions vc=90m/min f=0.1mm/rev Wet</p>		
<p>GND series</p> <p>(Continuous Feed)</p>	<p>Conventional Tool</p> <p>(Step Feed)</p>	
<ul style="list-style-type: none"> · Excellent chip control performance · 20% greater machining efficiency 		

SCr420H Gearshaft Grooving		P
<p>Point</p> <ul style="list-style-type: none"> · High rigidity · Chatter · Chip control 		
<p>Holders GNDM R2525M-312</p> <p>Insert GCM N3004-GG</p> <p>Width of Cut: 3.0mm</p> <p>Cutting Conditions vc=100m/min f=0.12mm/rev Wet</p>		
<p>GND series</p>	<p>Conventional Tool</p>	
<ul style="list-style-type: none"> · Stable cutting without chattering or vibration · Excellent chip control performance 		

SUS304 Measuring Component Grooving		M
<p>Point</p> <ul style="list-style-type: none"> · High rigidity · Chatter · Chip control 		
<p>Holders GNDL R2525M-320</p> <p>Insert GCM N3002-GG</p> <p>Width of Cut: 3.0mm</p> <p>Cutting Conditions vc=60m/min f=0.025mm/rev Wet</p>		
<ul style="list-style-type: none"> · Stable cutting without chattering or vibration · Excellent chip control performance 		

Sintered Ferrous Material Crank Sprocket Gear Grooving / Finishing		Sintered Alloy
<p>Point</p> <ul style="list-style-type: none"> · High rigidity · Chatter · Chip control · Wear resistance 		
<p>Holders GNDL R2525M-220</p> <p>Insert GCM N2002-GG</p> <p>Width of Cut: 2.0mm</p> <p>Cutting Conditions vc=100m/min f=0.08mm/rev Wet</p>		
<p>GND series</p> <p>90 pcs</p> <p>Able to continue</p>	<p>Conventional Tool</p> <p>70 pcs</p>	
<ul style="list-style-type: none"> · Stable cutting without chattering or vibration · Excellent chip control performance · Excellent wear resistance increasing tool life by 130% or more 		

■ Application Examples

S48C Tempered Machine Component Cut-off P	
	<p>Point</p> <ul style="list-style-type: none"> · High rigidity · Chatter · Fracture resistance <p>Holders GNDL R2525M-320</p> <p>Insert GCM N3002-GG</p> <p>Width of Cut: 3.0mm</p> <p>Cutting Conditions n=1,600min⁻¹ vc=200m/min f=0.05mm/rev Wet</p>
<ul style="list-style-type: none"> · Stable cutting without chattering or vibration · Excellent fracture resistance · Stable fracture resistance 	

S45C Valve Cut-off P	
	<p>Point</p> <ul style="list-style-type: none"> · High rigidity · Chatter · Chip control <p>Holders GNDM R2525M-312</p> <p>Insert GCM N3002-ML</p> <p>Width of Cut: 3.0mm</p> <p>Cutting Conditions vc=150m/min f=0.05 to 0.15mm/rev Wet</p>
<ul style="list-style-type: none"> · Stable cutting without chattering or vibration · Stable chip control 	

SCM435 Tempered Hydraulic Component Cut-off P	
	<p>Point</p> <ul style="list-style-type: none"> · Chip control · Wear resistance <p>Holders GNDL R2525M-320</p> <p>Insert GCM N3002-GG</p> <p>Width of Cut: 3.0mm</p> <p>Cutting Conditions n=4,000min⁻¹ vc=200m/min f=0.05mm/rev Wet</p>
<ul style="list-style-type: none"> · Stable chip control · Excellent wear resistance 	

SCM435 Crank Cut-off P	
	<p>Point</p> <ul style="list-style-type: none"> · High rigidity · Chatter · Chip control <p>Holders GNDL R2525M-320</p> <p>Insert GCM N3002-GG</p> <p>Width of Cut: 3.0mm</p> <p>Cutting Conditions vc=115m/min f=0.30mm/rev Wet</p>
<ul style="list-style-type: none"> · Improved machining efficiency · Stable cutting without chattering or vibration · Stable chip control 	

SKD61 (45 to 48HRC) Machine Component Cut-off P	
	<p>Point</p> <ul style="list-style-type: none"> · High rigidity · Chatter · Chip control <p>Holders GNDL R2525M-425</p> <p>Insert GCM N4002-GG</p> <p>Width of Cut: 4.0mm</p> <p>Cutting Conditions vc=50m/min f=0.03mm/rev Wet</p>
<ul style="list-style-type: none"> · Stable cutting without chattering or vibration · Excellent chip control performance · Unexpected fractures prevented 	

SKD61 (60HRC) Die Steel Cut-off P	
	<p>Point</p> <ul style="list-style-type: none"> · Chatter · Integrated Tools · Deep Grooving (Cut-off) <p>Holders GNDXL R2525M-332 </p> <p>Insert GCM N3002-ML1</p> <p>Width of Cut: 3.0mm</p> <p>Cutting Conditions vc=30m/min f=0.05mm/rev ap=25mm/rev Wet</p>
<ul style="list-style-type: none"> · Reducing the number of tools by integrating internal boring + external cut-off to only external cut-off · Tool integration reduces cutting time to 1/3 	

Guides
 External Dia.
 Face
 Internal Dia.
 Necking
 SumiPolygon
 Request Form
 Application Examples

■ Application Examples

S45C Equivalent Automotive Component Grooving / Traverse Cutting **P**

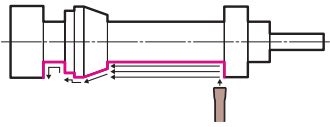

- Point**
- Machined surface
 - Tool life

Holders
 GNDM R2020K-418J
 Insert
 GCM N4004-ML
 Width of Cut: 4.0mm
 Cutting Conditions
 $n=2,500\text{min}^{-1}$
 $f=0.1\text{mm/rev}$
 $ap=0.5$ to 2.0mm
 Wet → Internal Coolant Supply (Normal Pressure)

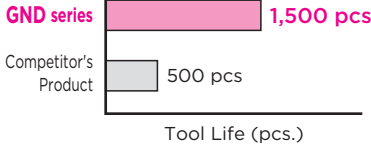

- Internal coolant supply effectively cools the cutting edge, achieving 3 times longer tool life
- Cutting edge sharpness is maintained and machined surface blemishes are improved

S53C Camshaft Grooving / Finishing (Continuous to Heavy Interrupted) **P**

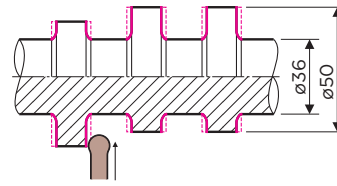

- Point**
- High rigidity
 - Chatter
 - Chip control
 - Fracture resistance

Holders
 GNDM L2525M-618
 Insert
 GCM N6030-RG
 Width of Cut: 6.0mm
 Cutting Conditions
 $vc=130\text{m/min}$
 $f=0.36\text{mm/rev}$
 Wet

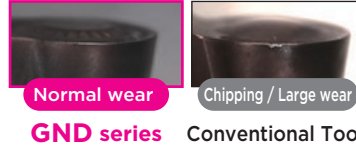

- Stable cutting without chattering or vibration
- Excellent fracture resistance
- Stable chip control

SCr415 Gearshaft Grooving / Profiling **P**

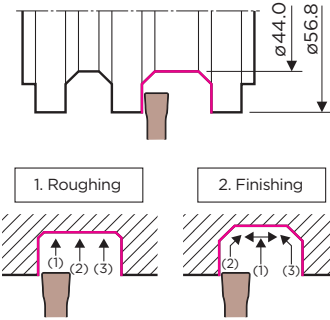

- Point**
- High rigidity
 - Chatter
 - Chip control

Holders
 GNDM R2020K-518
 Insert
 GCM N5008-MG
 Width of Cut: 5.0mm
 Cutting Conditions
 $vc=150\text{m/min}$
 $f=0.1\text{mm/rev}$
 Wet

- Stable cutting without chattering or vibration
- Excellent chip control performance

Cast Stainless Steel Turbine Housing Face Grooving / Groove Expansion **M**

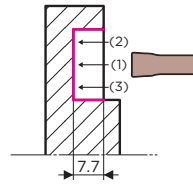

- Point**
- High rigidity
 - Tool life

Holders
 GNDS L2525M-410
 Insert
 GCM N4004-GF
 Width of Cut: 4.0mm
 Cutting Conditions
 $vc=80\text{m/min}$
 $f=0.1\text{mm/rev}$
 $ap=$ up to 7.7mm
 Dry

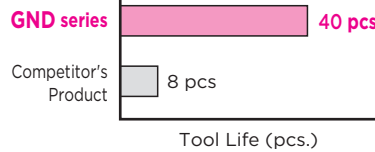

- Stable cutting without chattering or vibration
- Excellent wear resistance for 5 times longer tool life

Sintered Component Clutch Hub Face Grooving **Sintered Alloy**

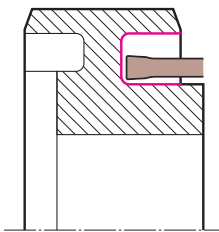

- Point**
- Machining efficiency
 - Chatter

Holders
 GNDF R2020K-523-050
 Insert
 GCM N5008-MG
 Width of Cut: 5.0mm
 Cutting Conditions
 $n=500\text{min}^{-1}$
 $vc=100\text{m/min}$
 $f=0.05\text{mm/rev}$
 Wet

- Reduces cycle time by up to 20%
- Stable cutting without chattering or vibration

SCM420H Automotive Component Face Profiling **P**

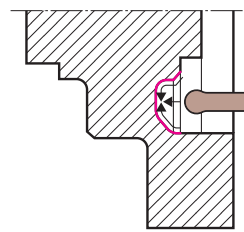

- Point**
- High rigidity
 - Chip control
 - Wear resistance

Holders
 GNDF R2525M-423-125
 Insert
 GCM N4020-RN
 Width of Cut: 4.0mm
 Cutting Conditions
 $vc=200\text{m/min}$
 $f=0.14\text{mm/rev}$
 Wet

- Excellent chip control performance
- Stable cutting without chattering or vibration

Guides

External Dia.

Face

Internal Dia.

Necking

SumiPolygon

Request Form

Application Examples

■ Application Examples

S45CD Motorcycle Transmission Component (Collar) Internal Grooving P

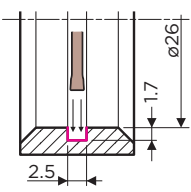

Point
 · Tool life
 · Chip control

Holders
 GNDIS R1620-T2046
 Insert
 GXM N2002S-GF
 Width of Cut: 2.0mm
 Cutting Conditions
 vc=150m/min
 f=0.03mm/rev
 ap=1.7mm
 Wet

GND series 1,100 pcs

Competitor's Product A 900 pcs

Competitor's Product B 600 pcs

Tool Life (pcs.)

· Realises stable chip control and longer tool life with high-rigidity tool and 3D chipbreaker

SCM420 Automotive Component (Coupling) Internal Grooving P

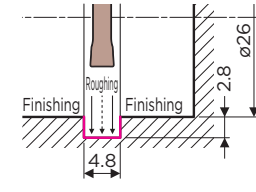

Point
 · Machining efficiency
 · Chip control

Holders
 GNDIS R1620-T2046
 Insert
 GXM N2002S-GF
 Width of Cut: 2.0mm
 Cutting Conditions
 vc = Roughing 50 to Finishing 80m/min
 f = Roughing 0.07 to Finishing 0.05mm/rev



· Excellent chip control eliminates the need for stepped roughing that is required with competitor's products

SCM415 Valve Spool Cut-off P

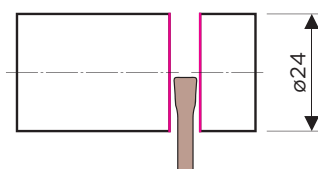

Point
 · Tool life
 · Chip control

SumiSmall

Holders
 GNDL R1212JX-1.2512
 Insert
 GCMN125005-GF
 Width of Cut: 1.25mm
 Cutting Conditions
 n=2,000min⁻¹
 f=0.05mm/rev
 Wet

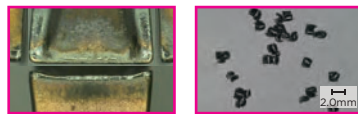

· Slight damage and able to continue even after cutting 7,500 pcs
 · Excellent chip control performance

Sintered Component Tap Component Grooving Sintered Alloy

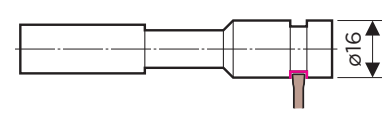

Point
 · Tool life
 · Chip control

SumiSmall

Holders
 GNDL L2020K-220J
 Insert
 GCM N2002-GF
 Width of Cut: 2.0mm
 Cutting Conditions
 vc=90m/min
 f=0.02mm/rev
 ap=2.0mm
 Wet → Internal Coolant Supply 1.5MPa

GND series 50 pcs

Competitor's Product 30 pcs

Tool Life (pcs.)

· Coolant supply from near the cutting edge directly to the cutting point, achieves 1.7 times longer tool life
 · Internal coolant supply realises stable chip control even at low feed machining

SCM435H Machine Component Cut-off P

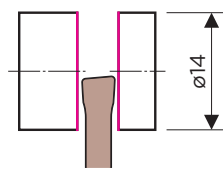

Point
 · Machined surface
 · Tool life

SumiSmall

Holders
 GNDM R2020K-210
 Insert
 GCM R20003-CF-15
 Width of Cut: 2.0mm
 Cutting Conditions
 n=2,500min⁻¹
 f=0.04mm/rev
 Wet

GND series 1,800 pcs

Competitor's Product 1,000 pcs

Tool Life (pcs.)

· Excellent chip control improves machined surface
 · Outstanding cutting edge sharpness for 1.8 times longer tool life

Pure Iron Automotive Component Cut-off P

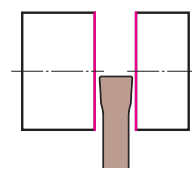

Point
 · Machining efficiency
 · Tool life

SumiSmall

Holders
 GNDM R1616JX-216J (Special)
 Insert
 GCM N2002-GF
 Width of Cut: 2.0mm
 Cutting Conditions
 vc= up to 145m/min
 f=0.06mm/rev
 ap=5.0mm
 Wet → Internal Coolant Supply (Normal Pressure)

GND series 10,000 pcs

Competitor's Product 2,500 pcs

Tool Life (pcs.)

· Internal coolant supply effectively cools the cutting edge, achieving 4 times longer tool life
 · Tool change reduced, enabling longer automatic operation
 · Improved productivity by changing to high-speed conditions

Guides
 External Dia.
 Face
 Internal Dia.
 Necking
 SumiPolygon
 Request Form
 Application Examples

■ Application Examples

SUM23 Free-cutting Steel Machine Component Cut-off P	
	<p>Point</p> <ul style="list-style-type: none"> · Tool life · Central burrs <p style="text-align: right;">SumiSmall</p> <p>Holders GNDL R1212JX-212.5</p> <p>Insert GCM R20003-CF-10</p> <p>Width of Cut: 2.0mm</p> <p>Cutting Conditions vc=122m/min f=0.05mm/rev ap=6.35mm Wet</p>
<p>GND series 2,800 pcs</p> <p>Competitor's Product 2,500 pcs</p> <p style="text-align: center;">Tool Life (pcs.)</p>	
<ul style="list-style-type: none"> · Excellent cutting edge sharpness for 1.2 times longer tool life · Central burrs eliminated with handed insert 	

SUS303 Hollow Round Bar Pipe Cut-off M	
	<p>Point</p> <ul style="list-style-type: none"> · Machining efficiency · Chatter <p style="text-align: right;">SumiSmall</p> <p>Holders GNDL R2020K-220</p> <p>Insert GCMR2002-CG-05</p> <p>Width of Cut: 2.0mm</p> <p>Cutting Conditions n=1,000min⁻¹ vc=140m/min f=0.03mm/rev Wet</p>
<p>GND series 2,800 pcs</p> <p>Competitor's Product 2,500 pcs</p> <p style="text-align: center;">Tool Life (pcs.)</p>	
<ul style="list-style-type: none"> · Sharp cutting edge provides stable cutting · Stable chip control for stable cutting 	

Stainless Steel Round Bar Cut-off M	
	<p>Point</p> <ul style="list-style-type: none"> · Tool life · Adhesion resistance <p style="text-align: right;">SumiSmall</p> <p>Holders GNDM L2020K-312</p> <p>Insert GCMN3002-GF</p> <p>Width of Cut: 3.0mm</p> <p>Cutting Conditions n=1,000min⁻¹ f=0.15→0.03mm/rev Wet</p>
<p>GND series 1,500 pcs</p> <p>Conventional Tool 1,000 pcs</p> <p style="text-align: center;">Tool Life (pcs.)</p>	
<ul style="list-style-type: none"> · Suppressed adhesion fracture achieves 150% tool life · Stable cutting without chattering or vibration 	

< SAFETY NOTES >



- Very hot or lengthy chips may be discharged while the machine is in operation. Therefore, machine guards, safety goggles or other protective covers must be used. Fire safety precautions must also be considered.
- Please handle with care as this product has sharp edges.
- Improper cutting conditions or mis-handling of the tool may result in breakages or projectiles. Therefore, please use the tool within its recommended conditions.
- When using non-water soluble cutting oil, precautions against fire must be taken and please ensure that a fire extinguisher is placed near the machine.

Sumitomo Electric Industries, Ltd.

Hardmetal Division

Global Marketing Department : 1-1-1, Koyakita, Itami,
 Hyogo 664-0016, Japan

<https://www.sumitool.com/global>